



---

**1985**

---

**BMW 635CSi**

---

**Electrical**

---

**Troubleshooting**

---

**Manual**

---

BMW of North America, Inc.  
Montvale, New Jersey

## **FOREWORD**

In the interests of continuing technical development work we reserve the right to modify designs and equipment.

Printed in USA

©Copyright BMW of North America, Inc.

Not to be reproduced wholly or in part  
without written permission of BMW of  
North America, Inc.  
PN 89 89 1 000 161

**1985  
BMW 635CSi  
Electrical  
Troubleshooting  
Manual**

**CONTENTS**

---

Index . . . . .	2
How To Use This Manual . . . . .	3
Symbols . . . . .	4
Wire Size Conversion Chart . . . . .	5
Systematic Troubleshooting . . . . .	6
Diagnostic Connector . . . . .	101
Power Distribution Box . . . . .	102
Accessory Connector . . . . .	103
Schematic Diagrams . . . . .	104
Component Charts and Figures . . . . .	201

---

The purpose of this manual is to show electrical schematics in a manner that makes electrical troubleshooting easier. Electrical components which work together are shown together on one schematic. The Wiper-Washer schematic, for example, shows all of the electrical components in one diagram. At the top of the page is the fuse (positive) that powers the circuit. The flow of current is shown through all wires, connectors, switches, and motors to ground (negative) at the bottom of the page.

Within the schematic, all switches and sensors are shown "at rest," as though the Ignition Switch were off. For identification, component names are underlined and placed next to or above each component. Notes are included, describing how switches and other components work.

The power distribution schematic shows the current feed through all the connections from the Battery and Alternator to each fuse and the Ignition and Light Switches. If the Power Distribution schematic is combined with any other circuit schematic, a complete picture is made of how that circuit works. The Ground Distribution schematics show how several circuits are connected to common grounds.

All wiring between components is shown exactly as it exists in the vehicle; however, the wiring is not drawn to scale. To aid in understanding electrical operation, wiring inside complicated components has been simplified. The "Solid State" label designates electronic components.

WIRE SIZE CONVERSION CHART	
METRIC (CROSSSECTIONAL AREA IN MM <sup>2</sup> )	AWG (AMERICAN WIRE GAUGE)
.5	20
.75	18
1	16
1.5	14
2	14
2.5	12
4	10
6	8
8	8
16	4
20	4
25	2
32	2

WIRE INSULATION	
ABBREVIATIONS	COLOR
BK	BLACK
BR	BROWN
RD	RED
YL	YELLOW
GN	GREEN
BU	BLUE
VI	VIOLET
GY	GRAY
WT	WHITE
PK	PINK

# 4 SYMBOLS



ENTIRE COMPONENT SHOWN



PART OF A COMPONENT SHOWN



COMPONENT WITH SCREW TERMINALS

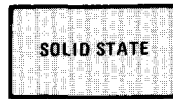

SOLID STATE (INCLUDES ONLY ELECTRONIC PARTS)

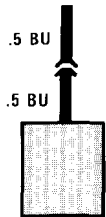

CONNECTOR ON COMPONENT LEAD (PIGTAIL)

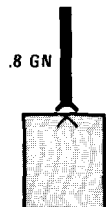

CONNECTOR ATTACHED TO COMPONENT



COMPONENT CASE IS DIRECTLY ATTACHED TO METAL PART OF CAR (GROUNDED)

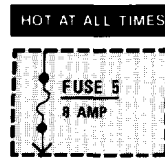

INDICATES THAT FUSE 5 IS ALWAYS SUPPLIED WITH POWER

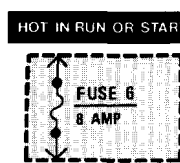

INDICATES THAT FUSE 6 IS SUPPLIED WITH POWER WITH THE IGNITION SWITCH IN THE RUN OR START POSITIONS

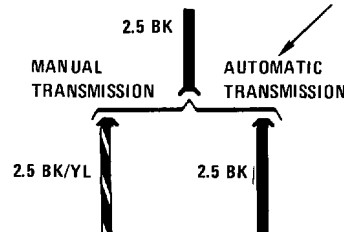

WIRE CHOICES FOR OPTIONS ARE SHOWN AND LABELED

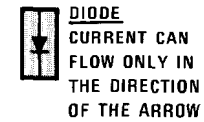
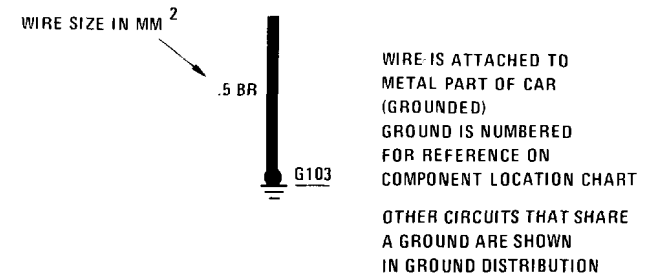
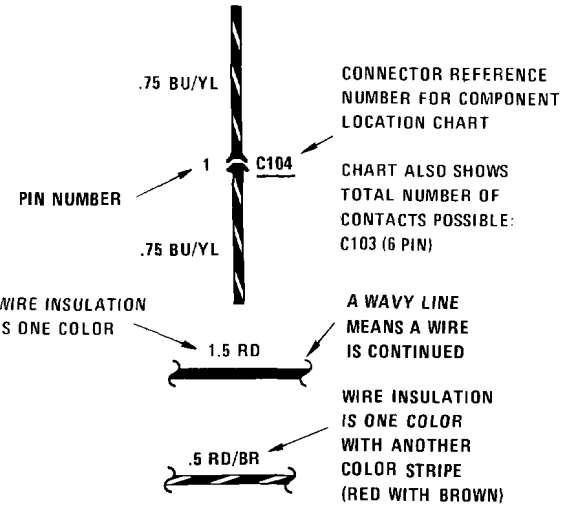

CIRCUIT REFERENCE - A WIRE WHICH CONNECTS TO ANOTHER CIRCUIT

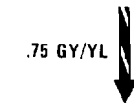

ACTIVE CHECK CONTROL

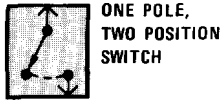

ONE POLE,  
TWO POSITION  
SWITCH

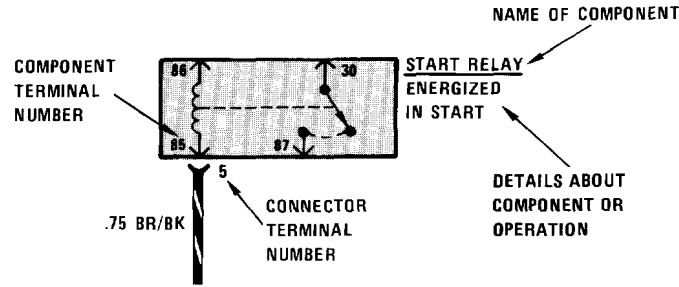

START RELAY  
ENERGIZED  
IN START

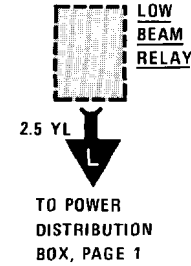

LOW  
BEAM  
RELAY

CURRENT PATH IS CONTINUED AS LABELED. THE ARROW SHOWS DIRECTION OF CURRENT FLOW AND IS REPEATED WHERE CURRENT PATH CONTINUES.

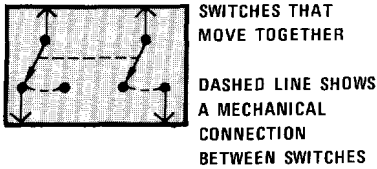

SWITCHES THAT  
MOVE TOGETHER  
DASHED LINE SHOWS  
A MECHANICAL  
CONNECTION  
BETWEEN SWITCHES

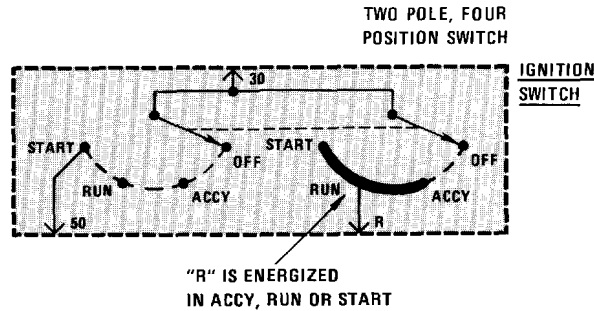

TWO POLE, FOUR  
POSITION SWITCH

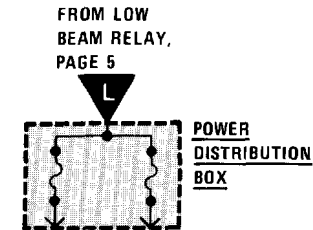

FROM LOW  
BEAM RELAY,  
PAGE 5

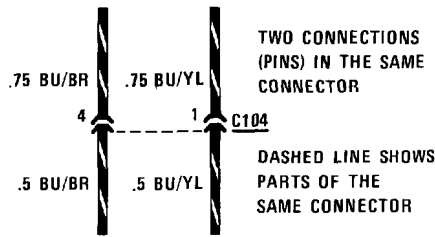

TWO CONNECTIONS  
(PINS) IN THE SAME  
CONNECTOR

DASHED LINE SHOWS  
PARTS OF THE  
SAME CONNECTOR

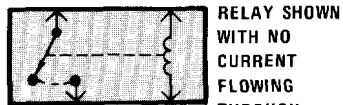

RELAY SHOWN  
WITH NO  
CURRENT  
FLOWING  
THROUGH  
COIL

WHEN COIL IS  
ENERGIZED, SWITCH  
IS PULLED CLOSED



RELAY SHOWN  
WITH RESISTOR  
ACROSS COIL

RESISTOR ACROSS COIL  
IS FOR NOISE  
SUPPRESSION



LIGHT  
EMITTING  
DIODE

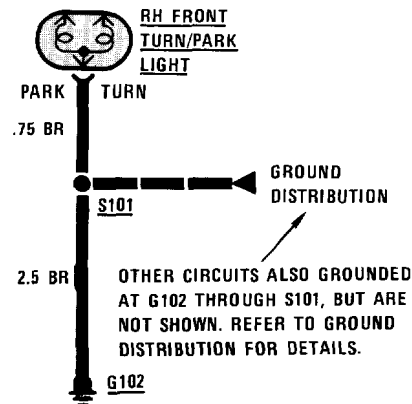

OTHER CIRCUITS ALSO GROUNDED AT G102 THROUGH S101, BUT ARE NOT SHOWN. REFER TO GROUND DISTRIBUTION FOR DETAILS.

## 6 SYSTEMATIC TROUBLESHOOTING

### TROUBLESHOOTING PROCEDURE

#### 1. Verify the Problem

Operate the problem circuit to check the accuracy of the complaint. Note the symptoms of the inoperative circuit.

#### 2. Analyze the Problem

Refer to the schematic of the problem circuit in the ETM. Determine how the circuit is supposed to work by tracing the current path(s) from the power feed through the circuit components to ground. Then based on the symptoms you noted in step 1 and your understanding of circuit operation, identify one or more possible causes of the problem.

#### 3. Isolate the Problem

Make circuit tests to prove or disprove the preliminary diagnosis made in step 2. Keep in mind that a logical simple procedure is the key to efficient troubleshooting. Test for the most likely cause of failure first. Try to make tests at points which are easily accessible.

#### 4. Repair the Problem

Once the specific problem is identified, make the repair using the proper tools and safe procedures.

#### 5. Check the Problem

Operate the circuit to check for satisfactory circuit operation. Good repair practice calls for rechecking all circuits you have worked on.

### TROUBLESHOOTING TOOLS

Isolating the problem (Step 3 of TROUBLESHOOTING PROCEDURES) requires the use of a **voltmeter** and/or **ohmmeter**. A voltmeter measures voltage at selected points in a circuit. An ohmmeter measures a circuit's resistance to current flow. It has an internal battery that provides current to the circuit under test. Disconnect the car battery when using an ohmmeter because the battery voltage will cause the ohmmeter to give false readings. Also, do not use an ohmmeter on solid-state components. The voltage that the ohmmeter applies to the circuit could damage these components.

### TROUBLESHOOTING TESTS

#### Voltage Test

This test measures voltage in a circuit. By taking measurements at several points (terminals or connectors) along the circuit, you can isolate the problem.

To take a voltage measurement, connect the negative lead of the voltmeter to the battery's negative terminal or other known good ground. Then connect the positive lead of the voltmeter to the point you want to test. The voltmeter will measure the voltage present at that point in the circuit.

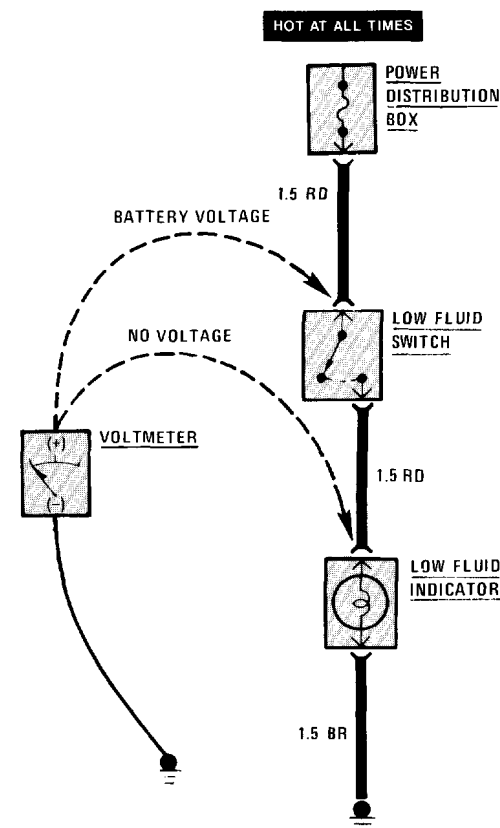

Voltage Test

Voltage Drop Test

Wires, connectors, and switches are designed to conduct current with a minimum loss of voltage. A voltage drop of more than one volt indicates a problem.

To test for voltage drop, connect the voltmeter leads to connectors at either end of the circuit's suspected problem area. The positive lead should be connected to the connector closest to the power source. The voltmeter will show the voltage drop between these two points.

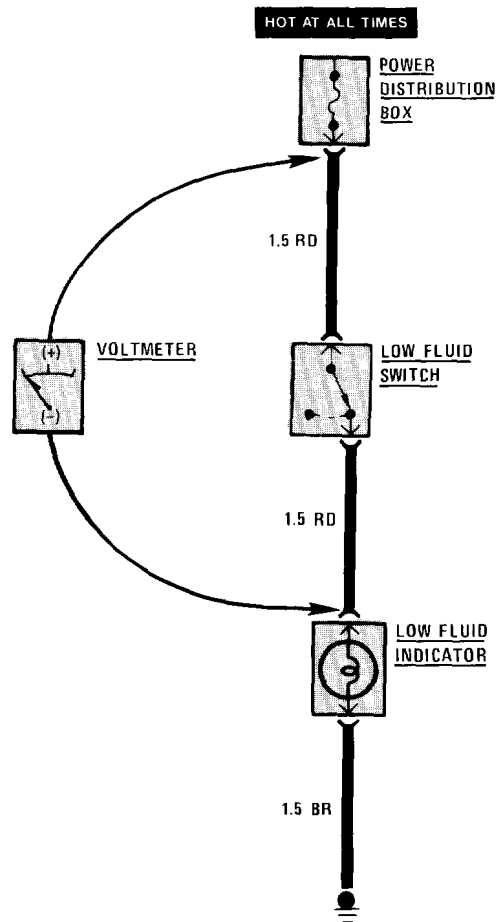

Voltage Drop Test

Continuity Test

To perform a continuity test, first disconnect the car battery. Then adjust the ohmmeter to read zero while holding the leads together. Connect the ohmmeter leads to connector or terminals at either end of the circuit's suspected problem area. The ohmmeter will show the resistance across that part of the circuit.

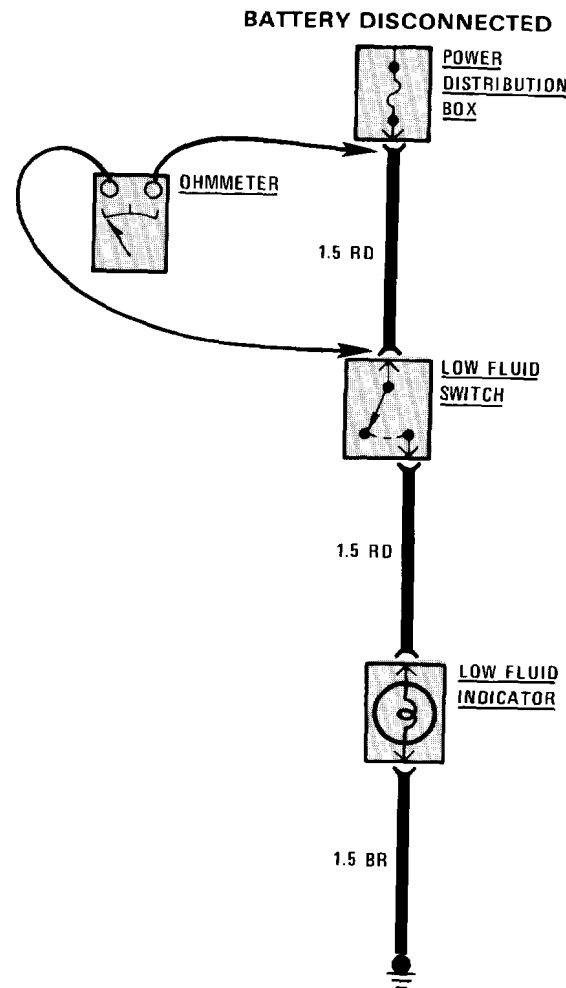

Continuity Test

Short Test Using Voltmeter

Remove the blown fuse and disconnect the load. Connect the voltmeter leads to the fuse terminals. The positive lead should be connected to the terminal closest to the power source.

Starting near the POWER DISTRIBUTION BOX, move the wire harness back and forth and watch the voltmeter reading. If the voltmeter registers a reading, there is a short to ground in the wiring. Somewhere in the area of the harness being moved, the wire insulation is worn away and the circuit is grounding.

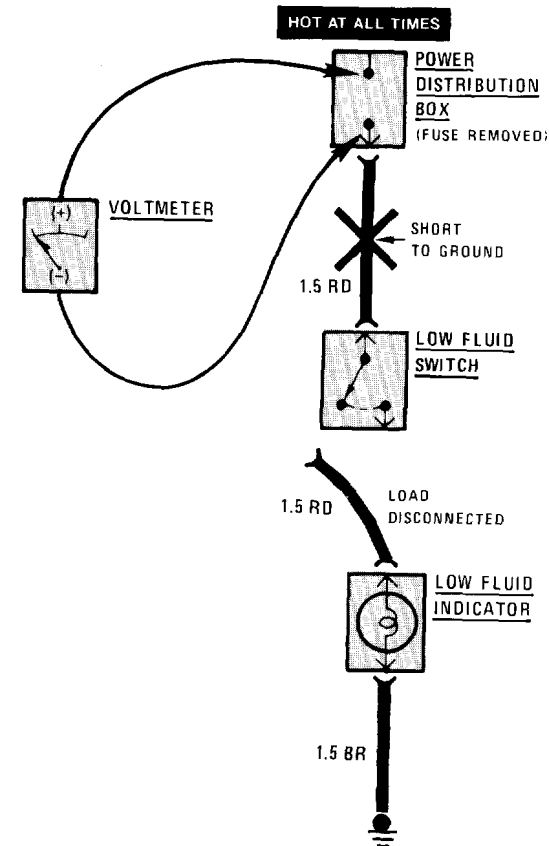

Short Test Using Voltmeter



## 8 SYSTEMATIC TROUBLESHOOTING

### Short Test Using Ohmmeter

Disconnect the battery. Adjust the ohmmeter to read zero while holding the leads together. Remove the blown fuse and disconnect the load. Connect one lead of the ohmmeter to the fuse terminal that is closest to the load. Connect the other lead to a known good ground.

Starting near the POWER DISTRIBUTION BOX, move the wire harness back and forth and watch the ohmmeter reading. Low or no resistance indicates a short to ground in the wiring. Infinitely high resistance indicates no short.

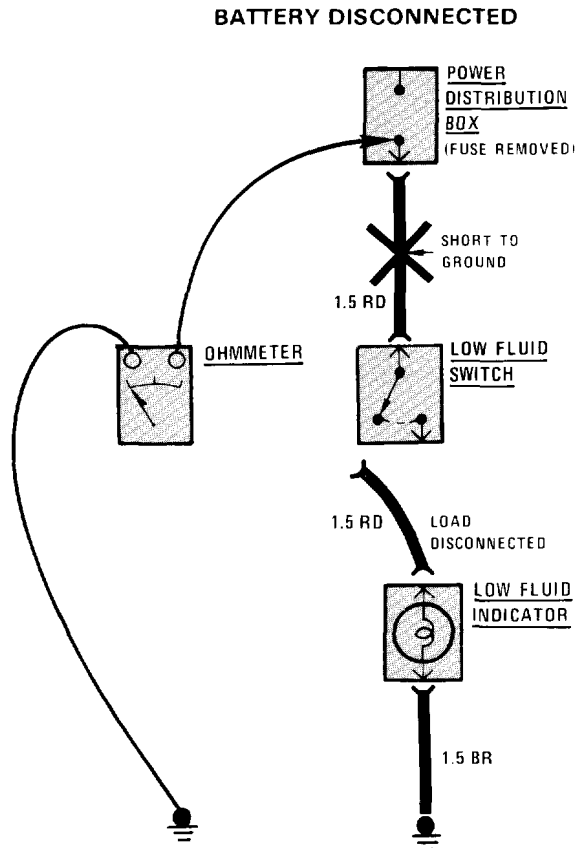

Short Test Using Ohmmeter

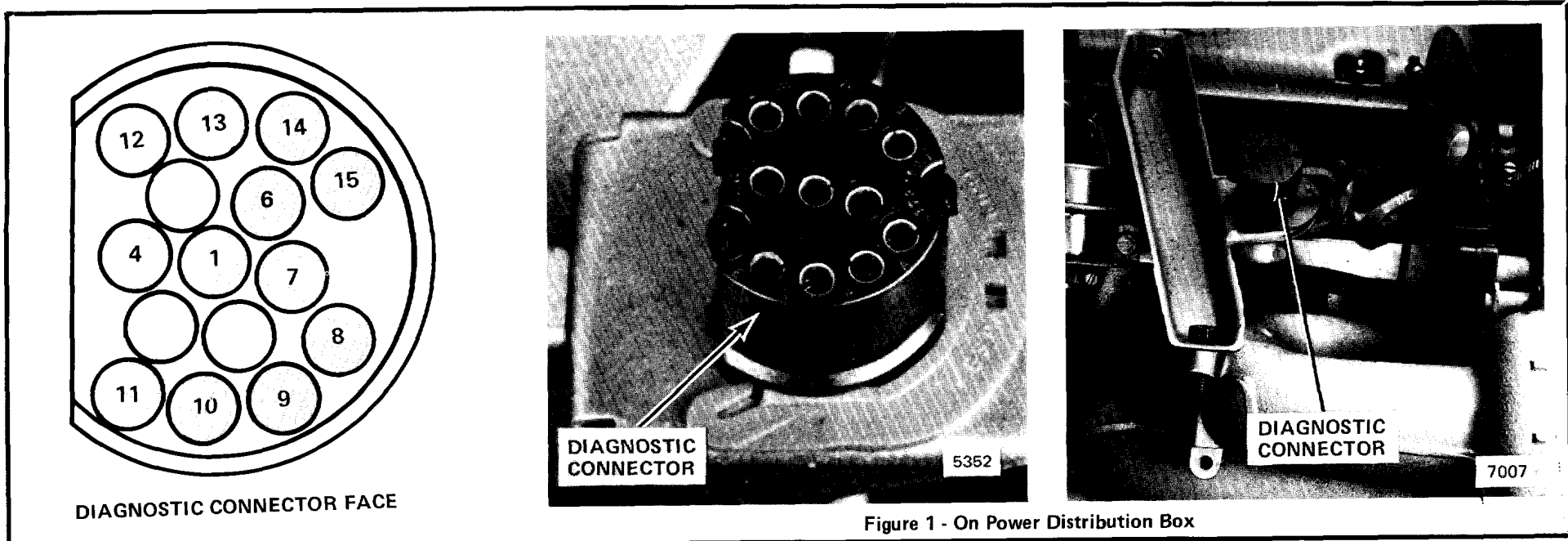

Figure 1 - On Power Distribution Box

PIN	WIRE SIZE	WIRE COLOR	CIRCUIT AND COMPONENT CONNECTED
1	1.5	BR	Ground Distribution, G103
4	.5	BR/WT	Gauges/Warning Indicators, Coolant Temperature Sender.
6	.5	WT/ BK	Not Used (Wiring Shown On Charging System)
7	.5	WT/BU	Service Interval Indicator, Service Interval Processor (Reset).
8	.5	YL	Ignition, TDC Sensor.
9		SHIELD	Ignition, TDC Sensor.
10	.5	BK	Ignition, TDC Sensor.
11	2.5	BK/YL	Start, Start Signal.
12	.75	BU	Charge System, Alternator.
13	.75	GN	Ignition, Ignition Coil.
14	2.5	RD	Charge System, Alternator.
15	{1.5}	GN/YL	Oxygen Sensor, Oxygen Sensor Heater Relay.

# 102 POWER DISTRIBUTION BOX

**MAIN  
RELAY**

**NOTE**

On some cars, the position of the Fuel Pump and Purge Valve Relays may be the opposite of what is shown. Check relay wire colors for positive identification.

**DIAGNOSTIC  
CONNECTOR**

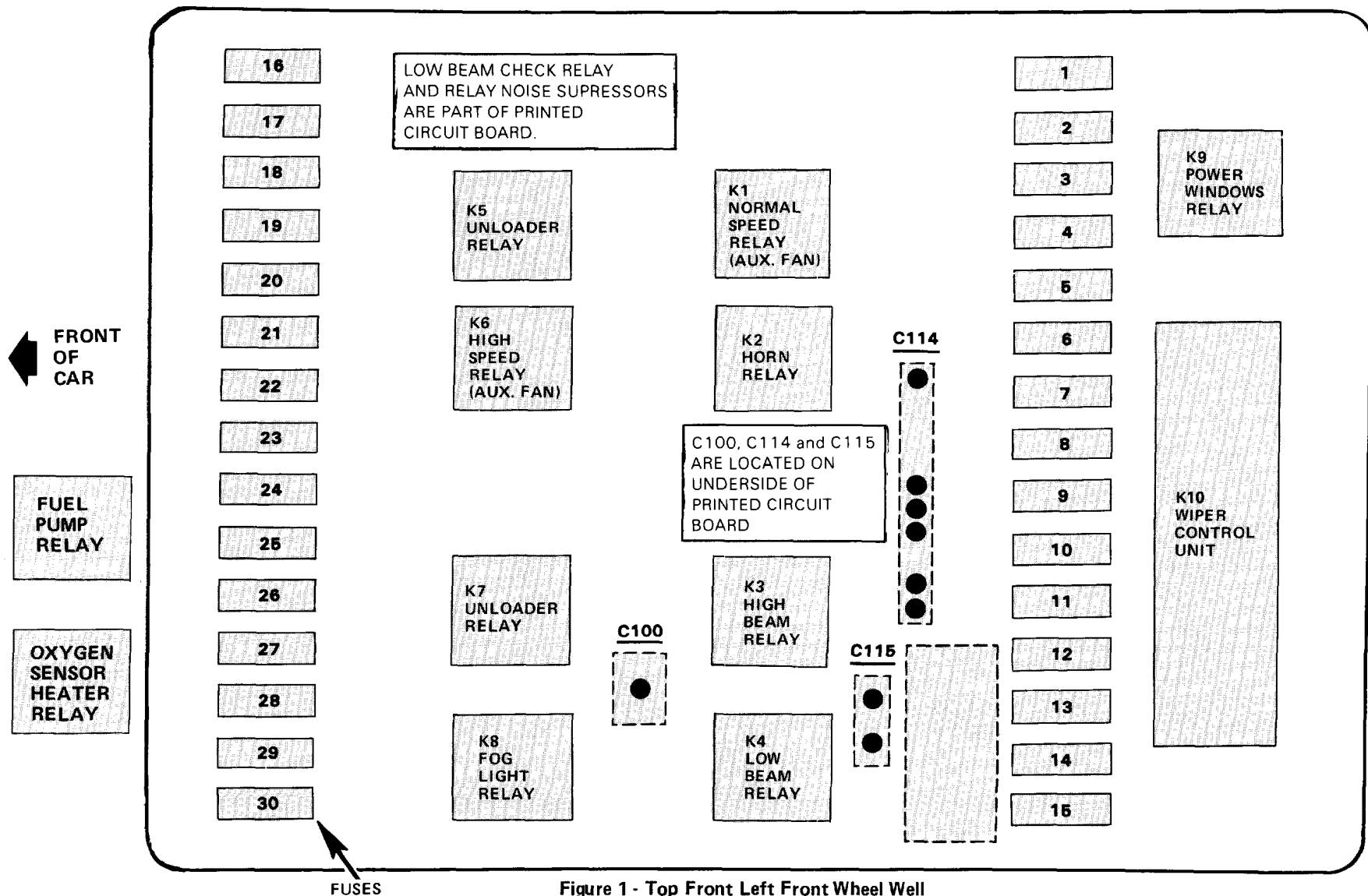

Figure 1 - Top Front Left Front Wheel Well

FUSE NO.	SIZE/COLOR	CIRCUIT PROTECTED
1	7.5A (BR)	Headlights (also fuses 2, 13, 14).
2	7.5A (BR)	Headlights (also fuses 1, 13, 14).
3	30A (LT GN)	Auxiliary Fan.
4	15A (LT BU)	Lights: Turn/Hazard Warning (also fuse 24).
5	30A (LT GN)	Wiper/Washer, Windshield Washer Jet Heater.
6	7.5A (BR)	Active Check Control (also fuse 10, 12, 21, 22, 23); Cruise Control (also fuse 17); Stoplights.
7	15A (LT BU)	Horn.
8		Not Used.
9	7.5A (BR)	Idle Speed Control (also fuse 17); Back Up Lights.
10	7.5A (BR)	Active Check Control (also fuses 6, 12, 21, 22, 23); On-Board Computer (also fuses 12, 21, 27); Speedometer/Gauges/Warning Indicators (also fuse 21); Brake Lining Warning; Service Interval Indicator (also fuse 21); Seatbelt Warning; Auxiliary Fan.
11	15A (LT BU)	Fuel Delivery.
12	7.5A (BR)	Active Check Control (also fuse 6, 10, 21, 22, 23); On-Board Computer (also fuses 10, 21, 27); Radio (also fuses 21, 28, Radio In-Line Fuse); Warning Indicators.
13	7.5A (BR)	<b>Headlights (also fuses 1, 2, 14)</b>
14	7.5A (BR)	Headlights (also fuses 1, 2, 13).
15		Not Used.
16	30A (LT GN)	Heating/Air Conditioning.
17	30A (LT GN)	Auxiliary Fan; Back Up Lights; Cruise Control (also fuse 6); Lights: Dash/ Transmission Range (also fuse 23); Heater/Air Conditioning; Interior Lights (also fuse 21); Power Mirrors; Seatbelt Warning.
18	30A (LT GN)	Auxiliary Fan.
19	30A (LT GN)	Sunroof.

FUSE NO.	SIZE/COLOR	CIRCUIT PROTECTED
20	30 (LT GN)	Rear Defogger (also fuse 23).
21	7.5A (BR)	Active Check Control (also fuses 6, 10, 12, 22, 23); Auto-Charging Flashlight; Gauges (also fuse 12); Glove Box Light; Interior Lights (also fuse 17); On-Board Computer (also fuses 12, 27); Radio (also fuses 12, 28, Radio In-Line Fuse); Service Interval Indicator (also fuse 10); Trunk Light.
22	7.5A (BR)	Active Check Control (also fuses 6, 10, 12, 21, 23); Lights: Front Park/Rail (also fuse 20).
23	7.5A (BR)	<b>Active Check Control (also fuses 6, 10, 12, 21, 22);</b> <b>Rear Defogger (also fuse 20);</b> <b>Lights: Front Park/Tail/Underhood (also fuse 22);</b> <b>Heater/Air Conditioning;</b> <b>Lights: Dash/Transmission Range/RH Visor (also fuse 17)</b> <b>Lights: Rear Marker/License.</b>
24	15A (LT BU)	Lights: Turn/Hazard Warning (also fuse 4).
25	25 A (WT)	Not Used
26	30A (LT GN)	Power Seats
27	30A (LT GN)	Central Locking; Heated Door Lock; On-Board Computer (also fuses 10, 21, 22).
28	30A (LT GN)	Cigar Lighter; Power Antenna (also fuses 12, 21, Radio In-Line Fuse).
29	7.5A (BR)	Fog Lights (also fuse 30).
30	7.5A (BR)	Fog Lights (also fuse 29).
Power Window Circuit Breaker	25	Power Windows.

**BLANK**

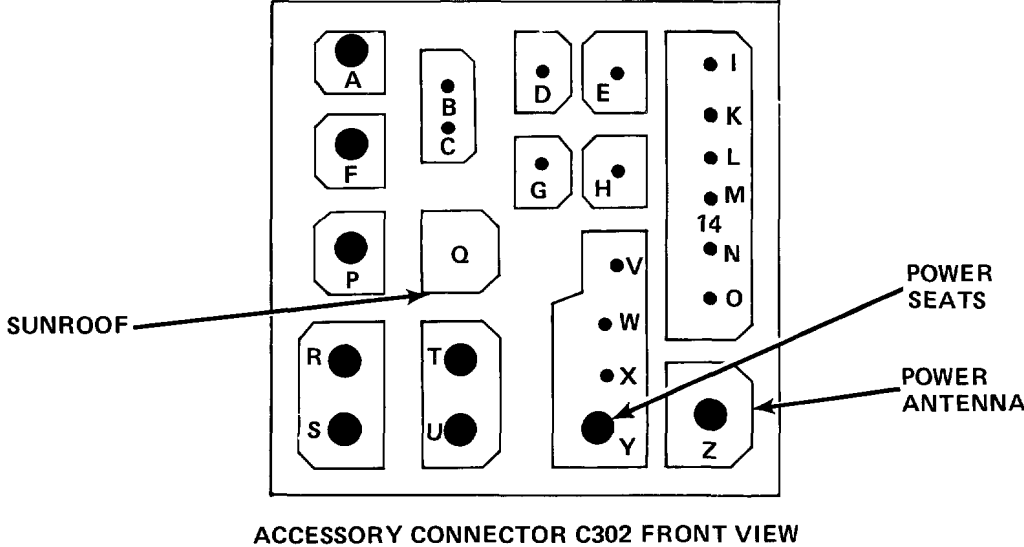
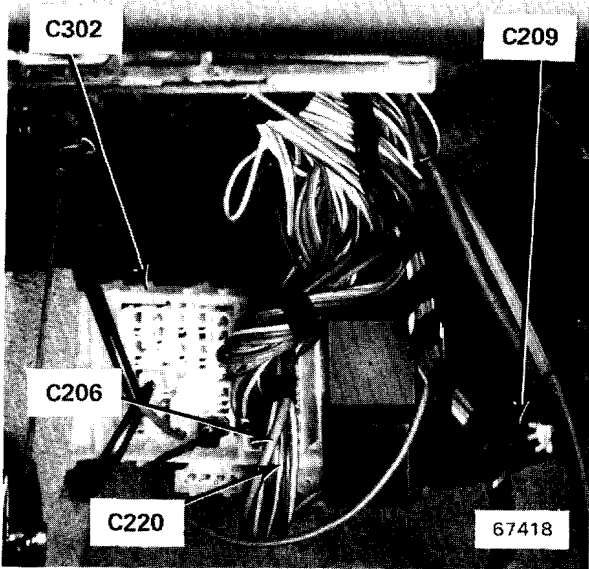
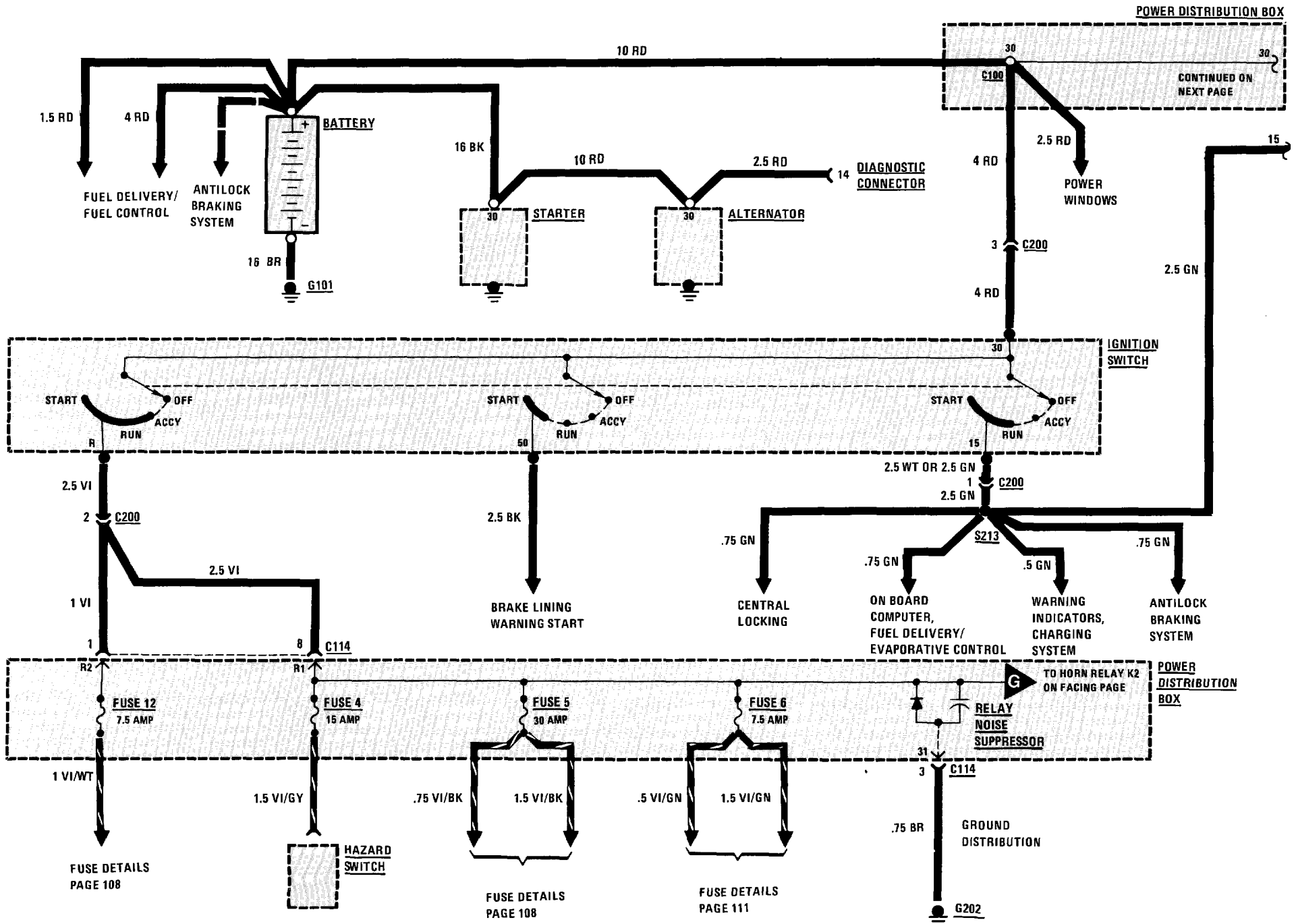

Figure 1 - Under Left Side Of Dash

# 104 POWER DISTRIBUTION

(For Component Locations See Page 208)



(For Component Locations See Page 208)

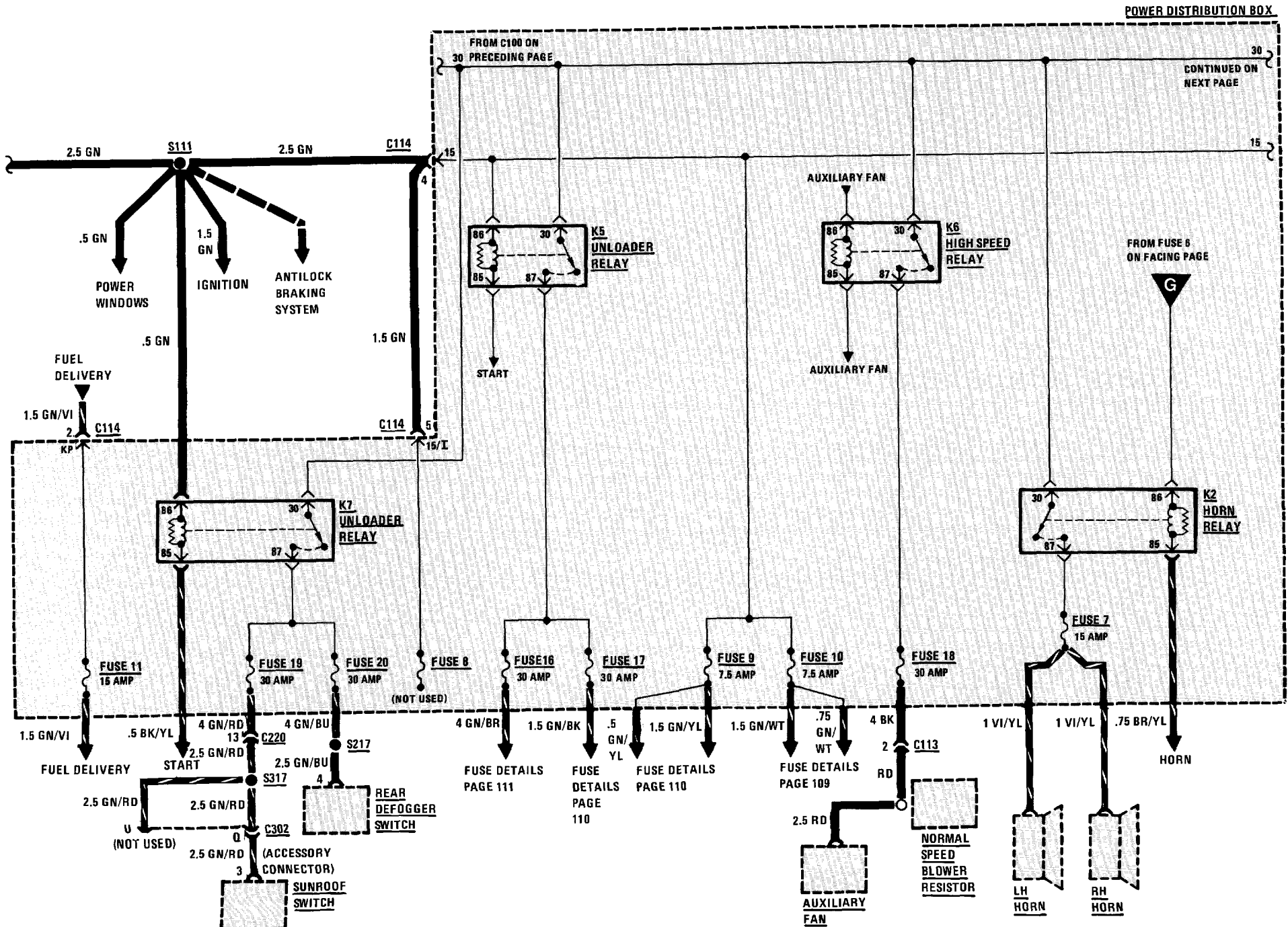



# 106 POWER DISTRIBUTION

(For Component Locations See Page 208)

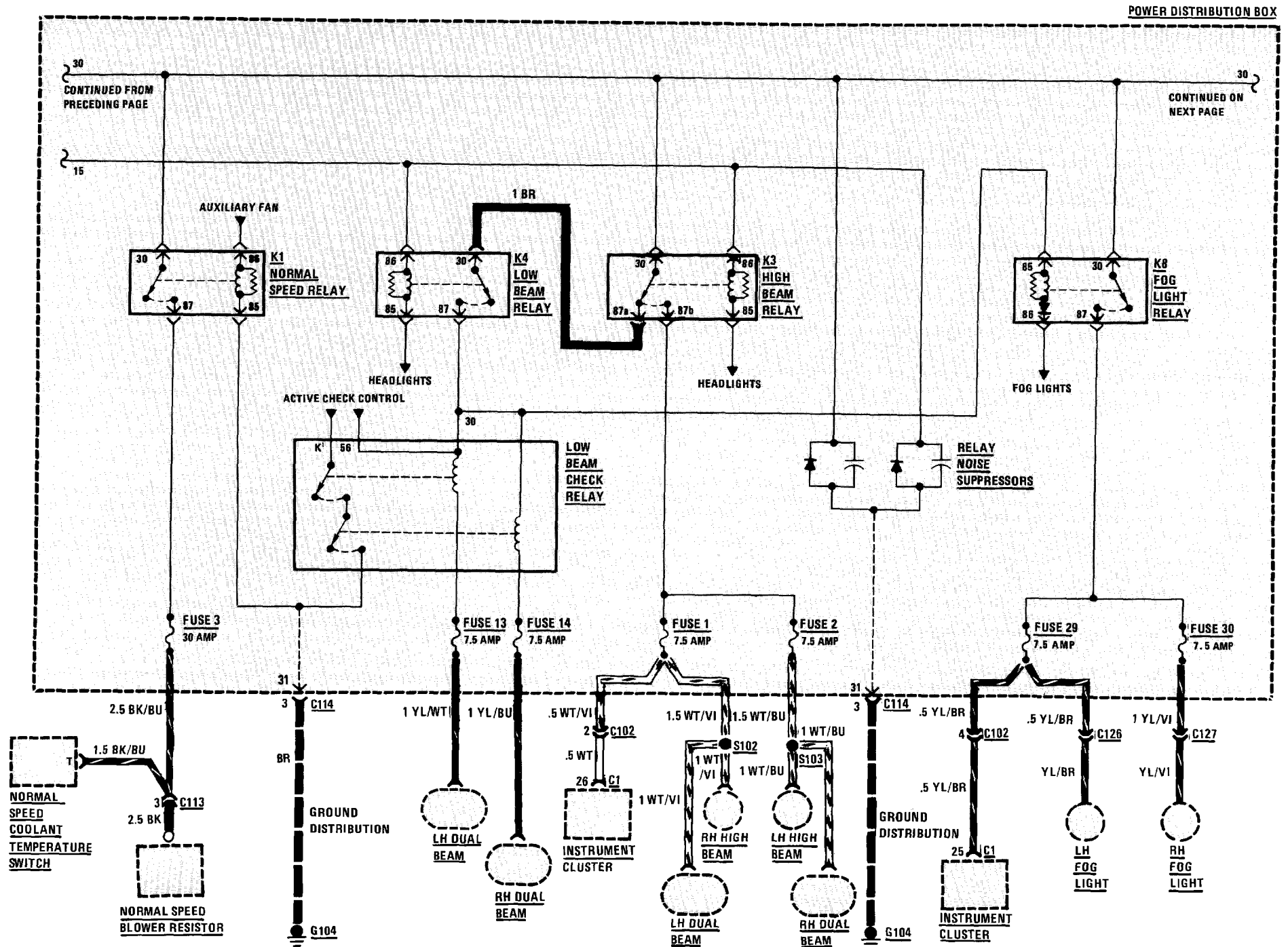



# 108 FUSE DETAILS FUSES 12 & 5

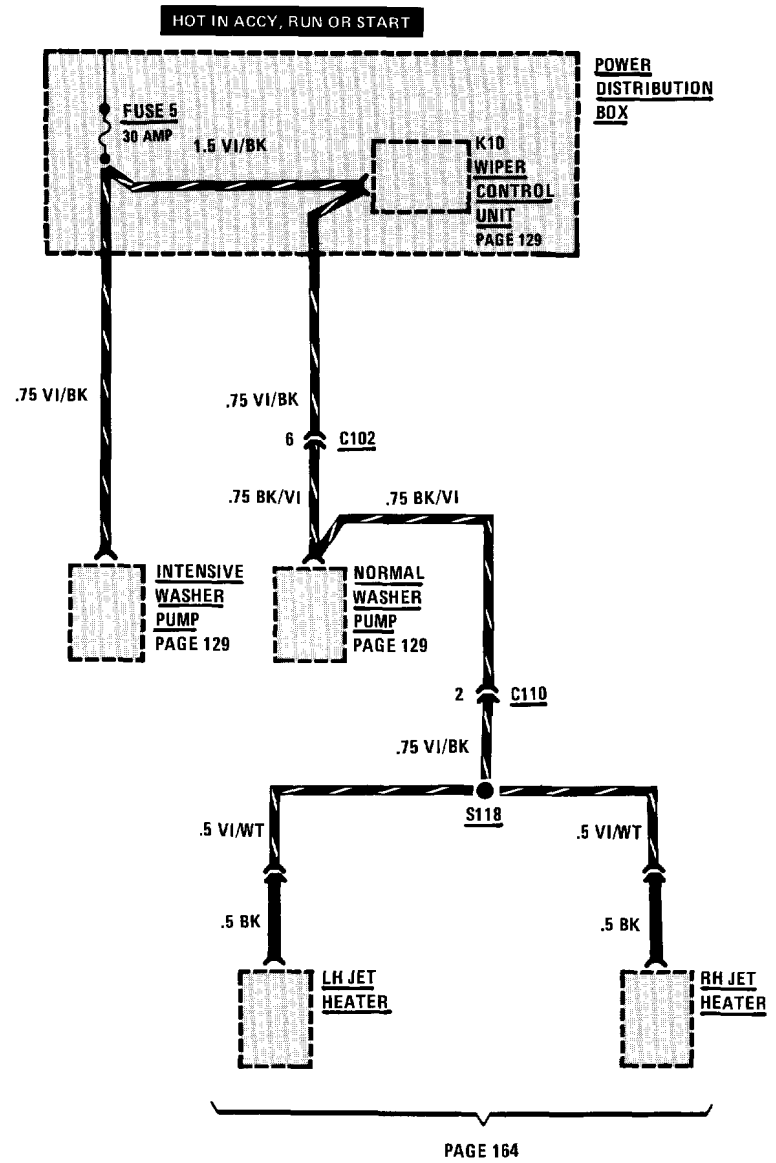
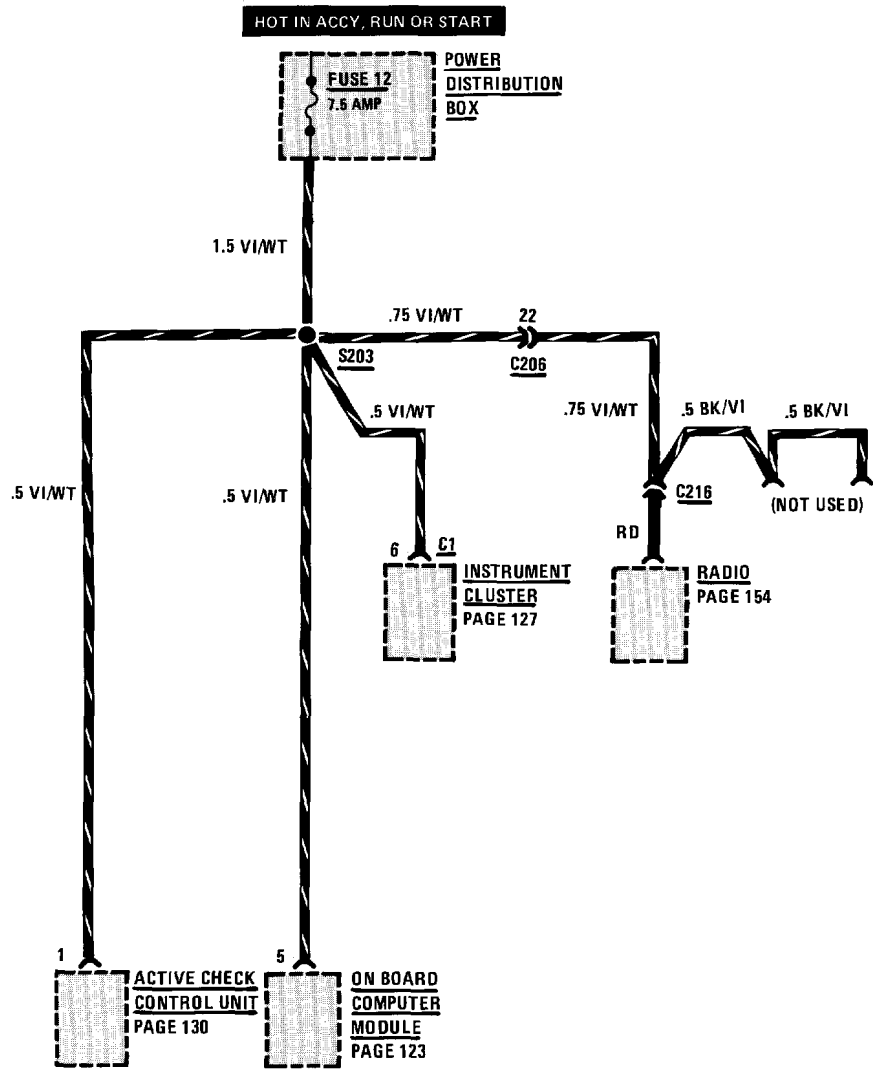

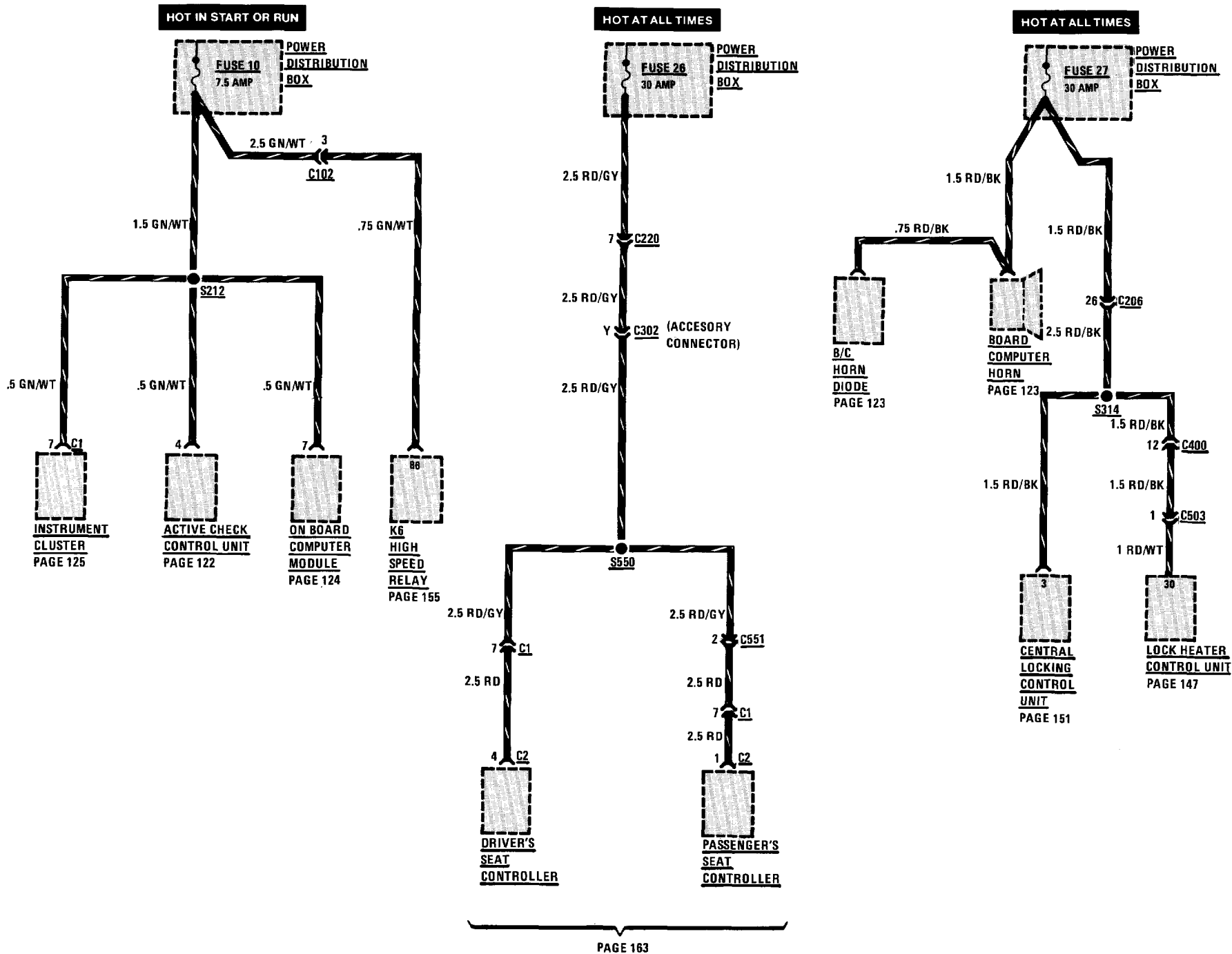



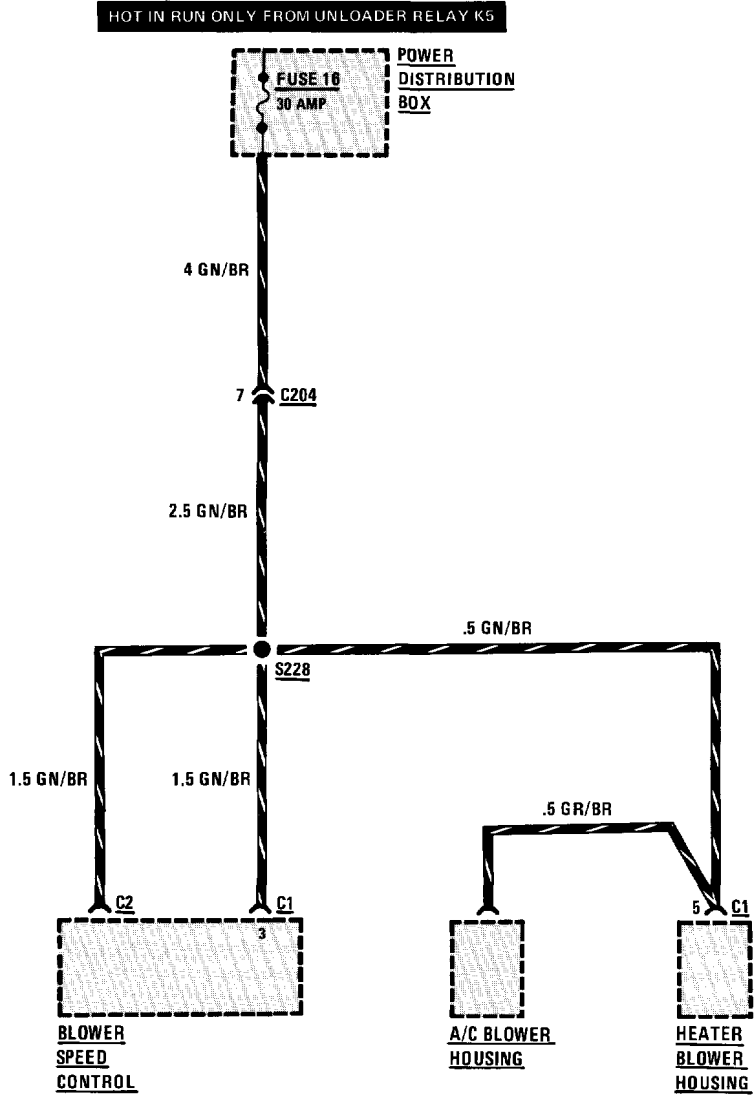
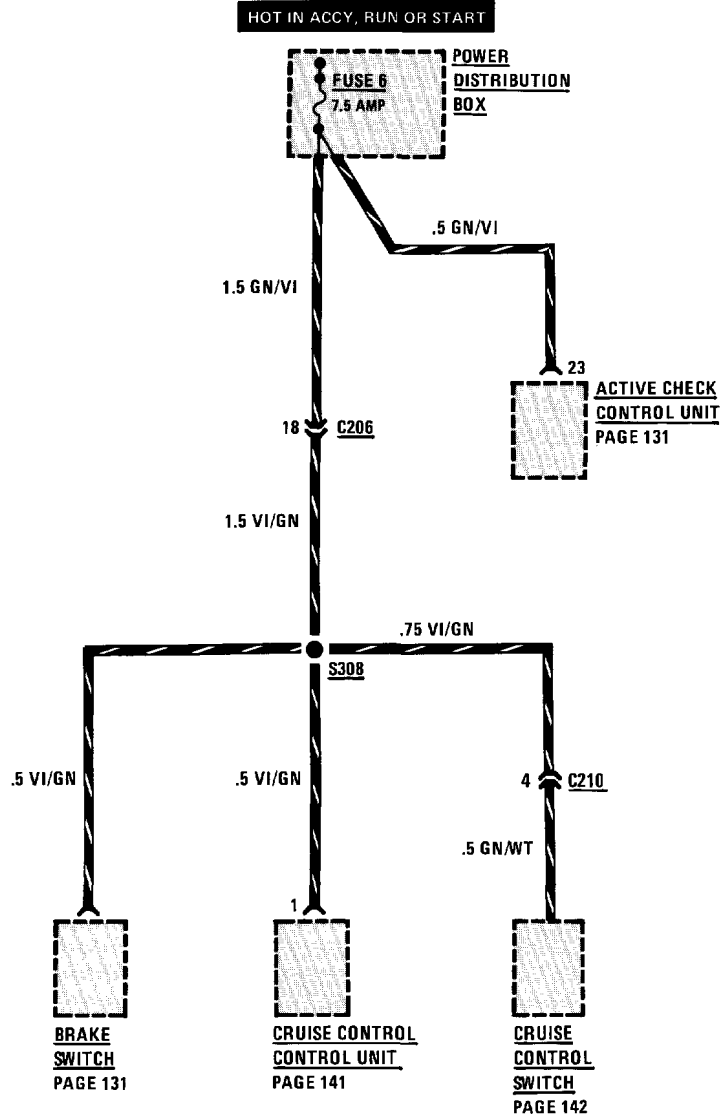

# 112 FUSE DETAILS FUSE 21

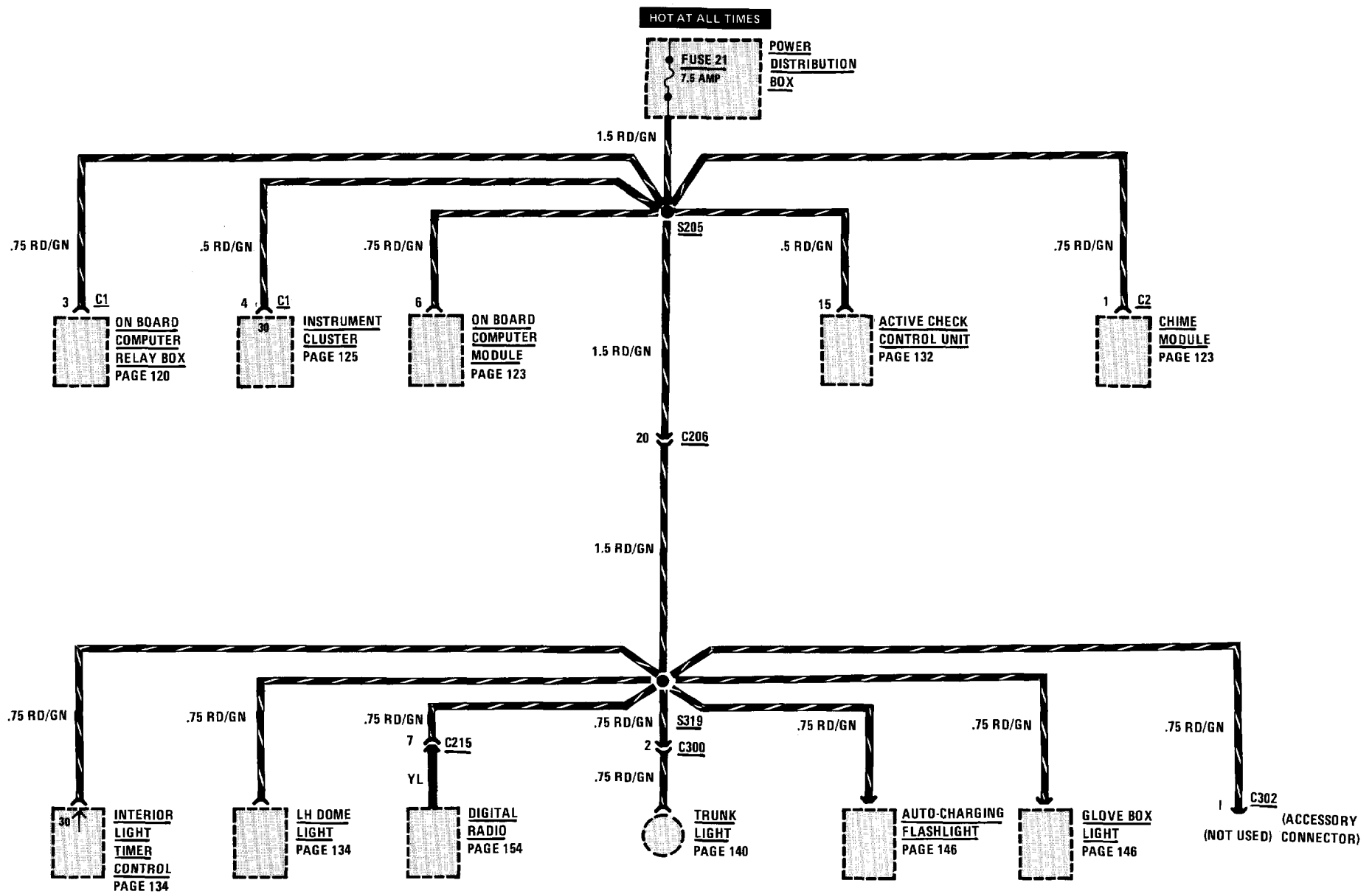





# 114 CHARGING SYSTEM

(For Component Locations See Page 202)

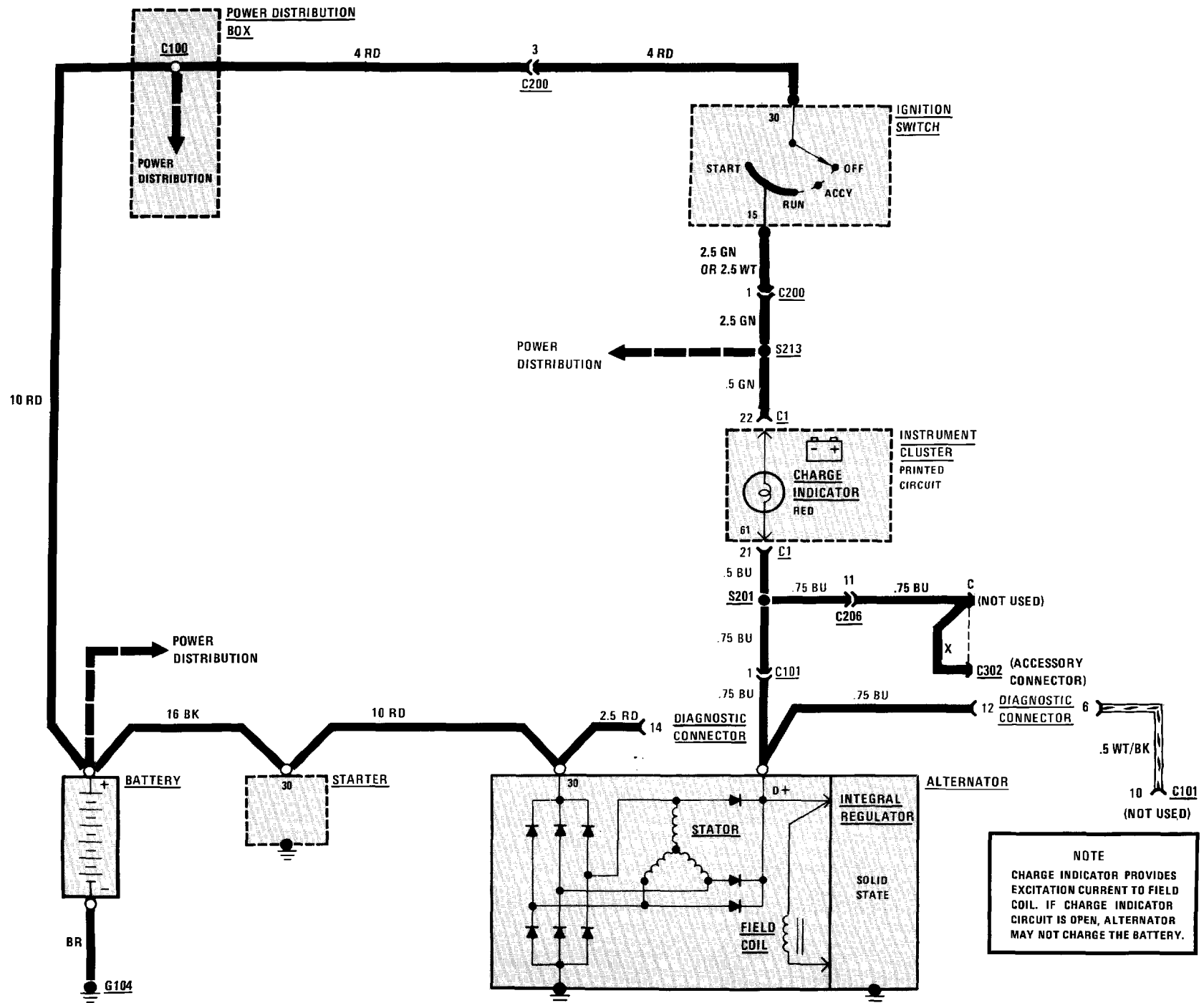

# START (MANUAL TRANSMISSION) 115

(For Component Locations See Page 211)

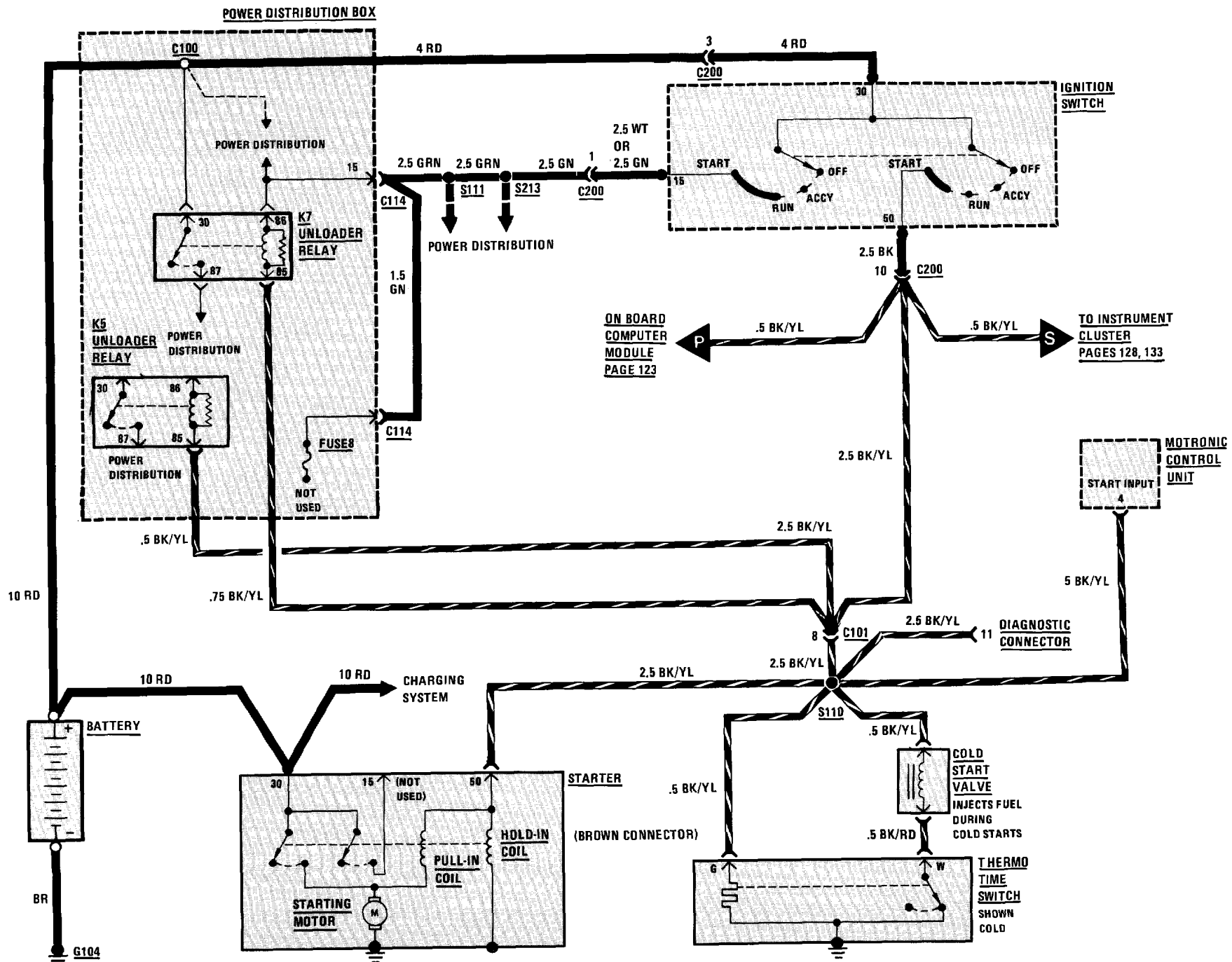

# 116 START (AUTOMATIC TRANSMISSION)

(For Component Locations See Page 211)

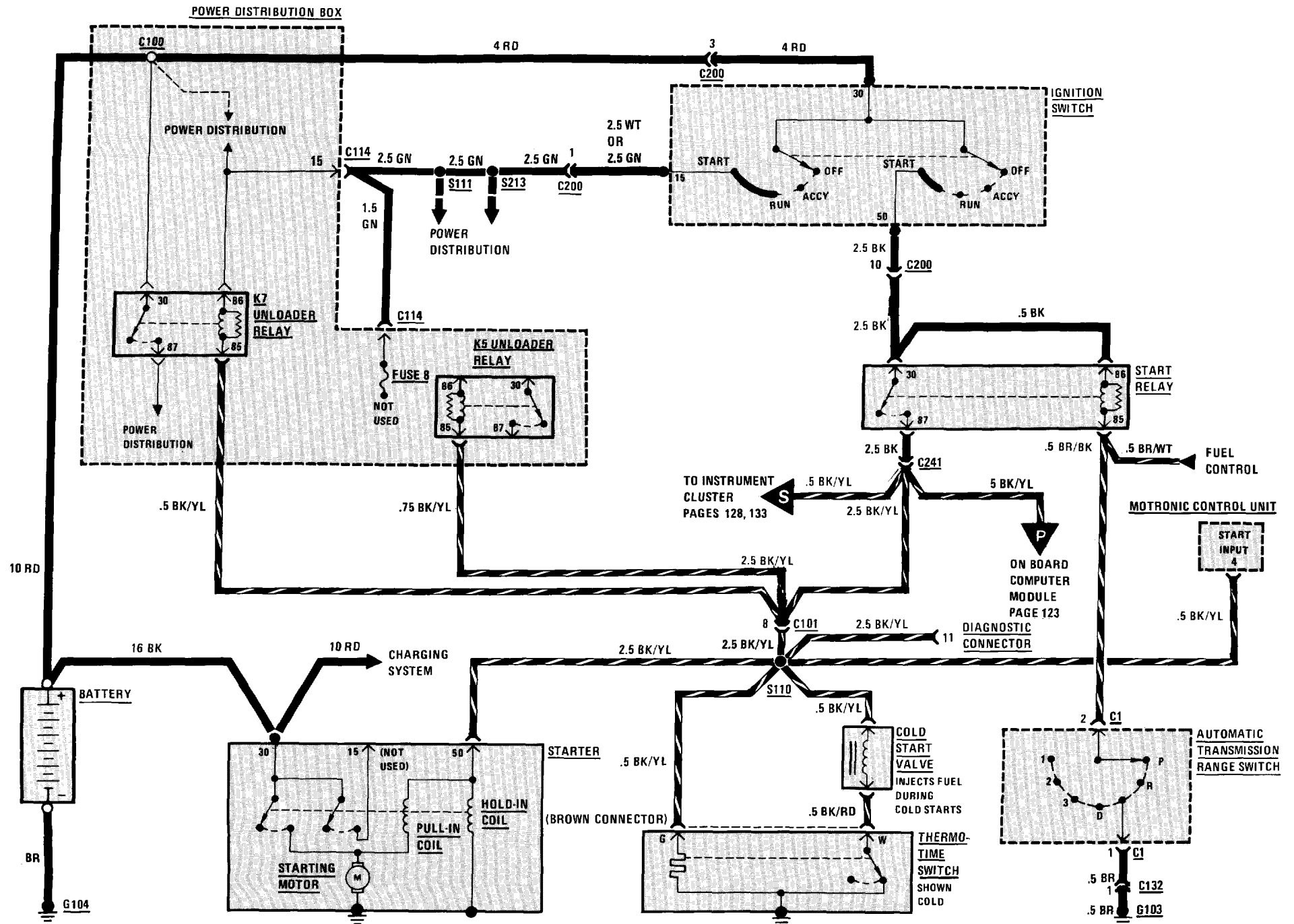

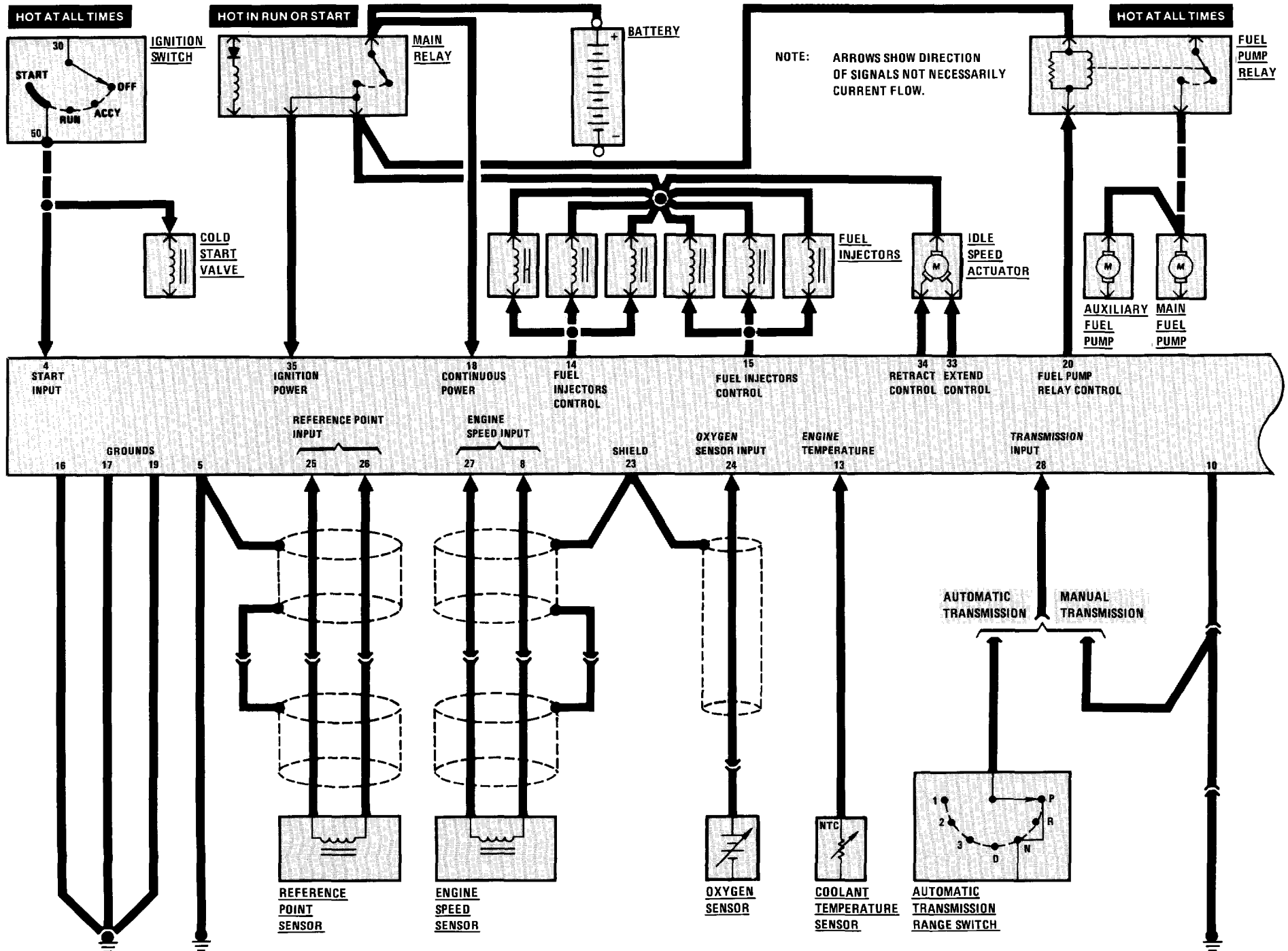

# 118 BLOCK DIAGRAMS FOR ENGINE CONTROLS

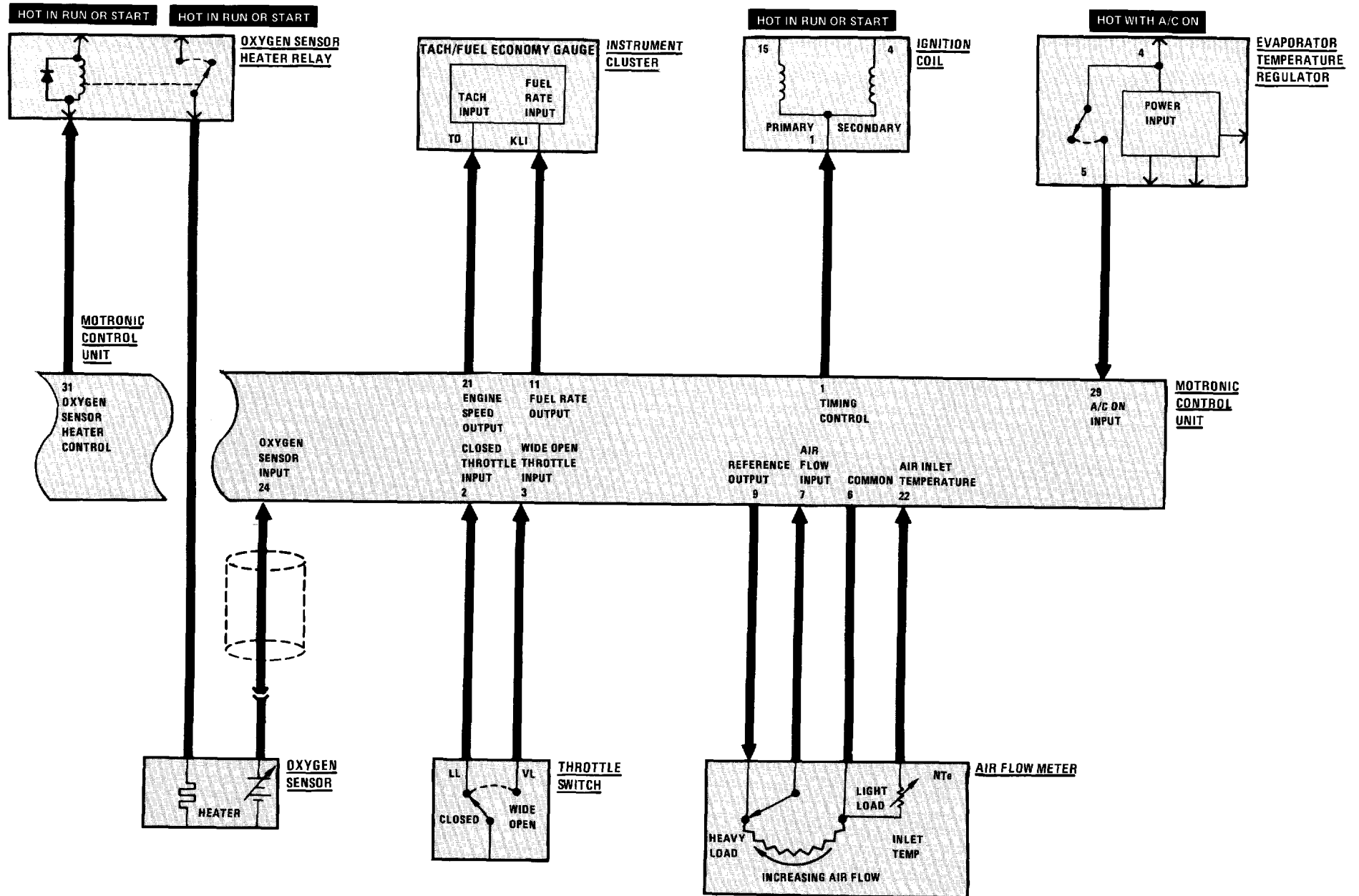

(For Component Locations See Page 203)

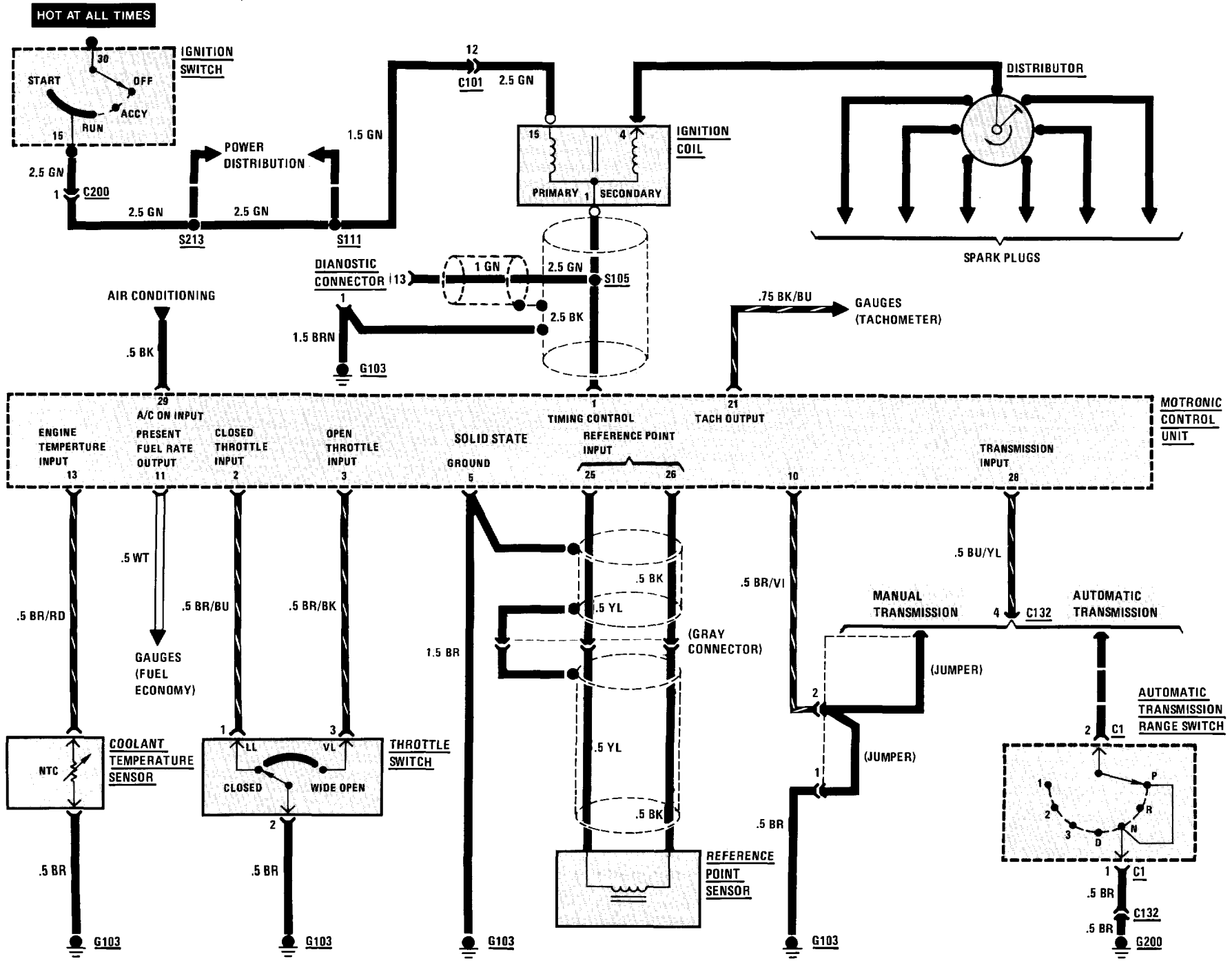

# 120 FUEL DELIVERY/FUEL CONTROL

(For Component Locations See Page 203)

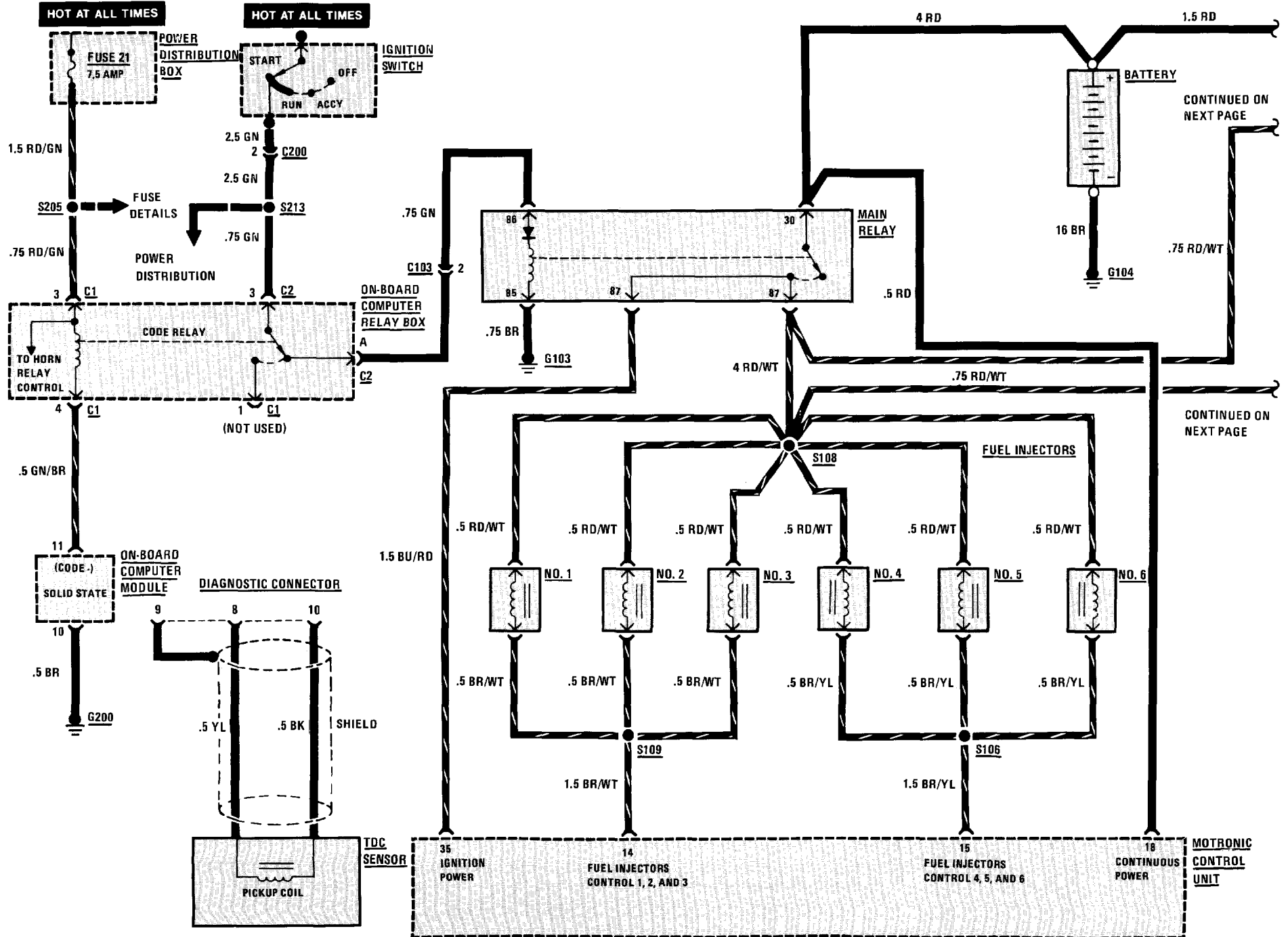

(For Component Locations See Page 203)

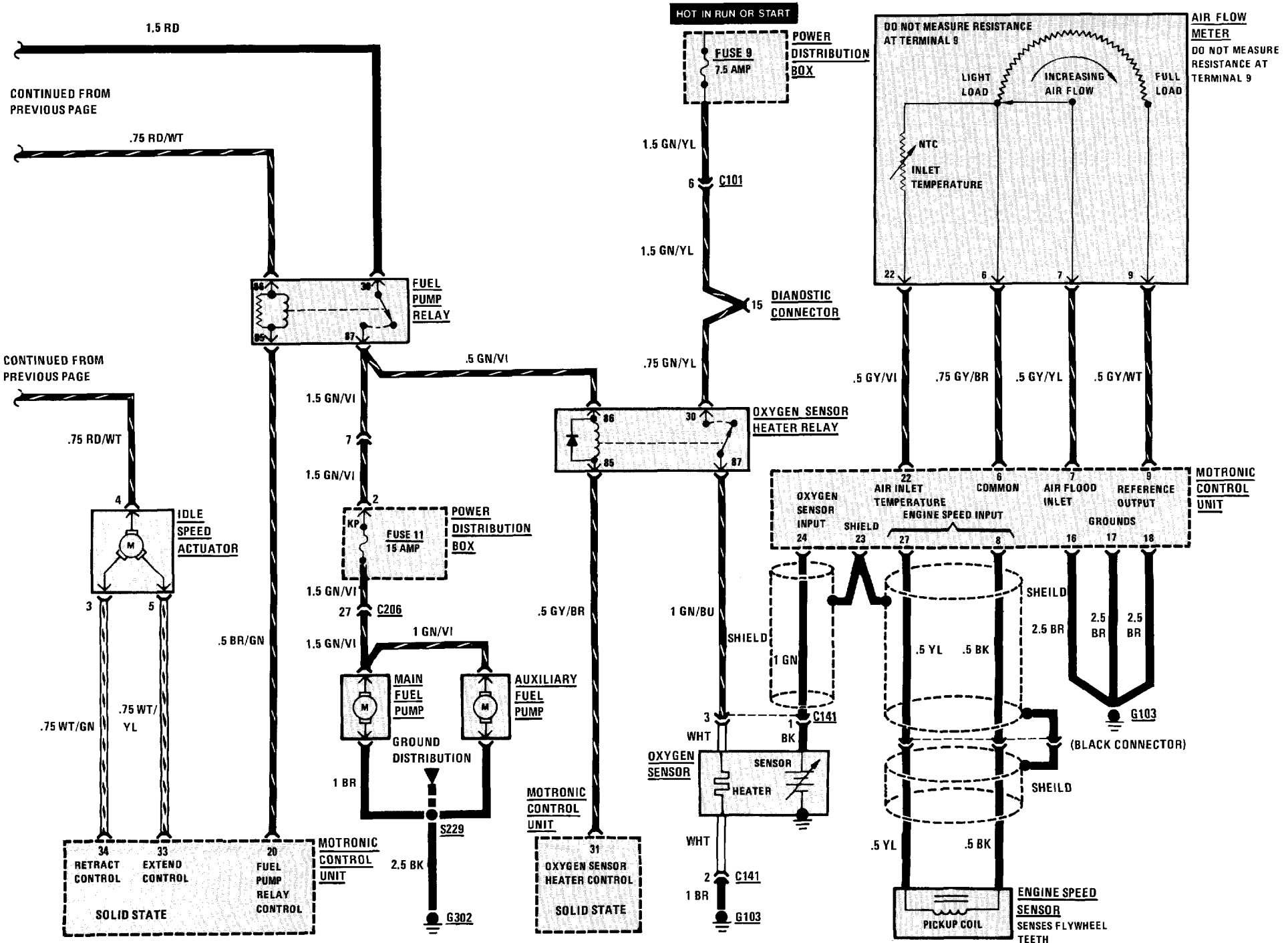



# 122 IGNITION KEY WARNING/SEATBELT WARNING

(For Component Locations See Page 206)

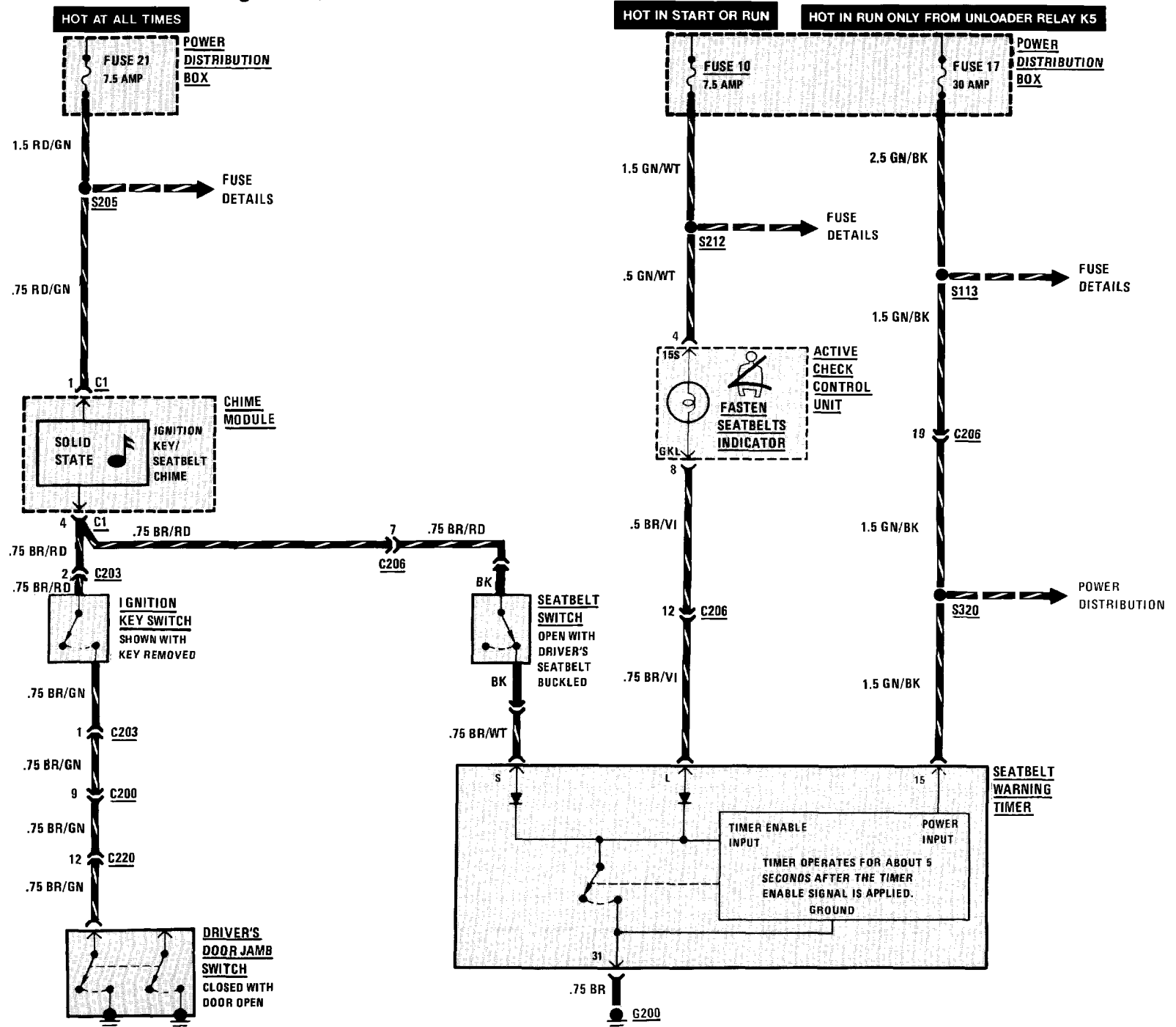

(For Component Locations See Page 208)

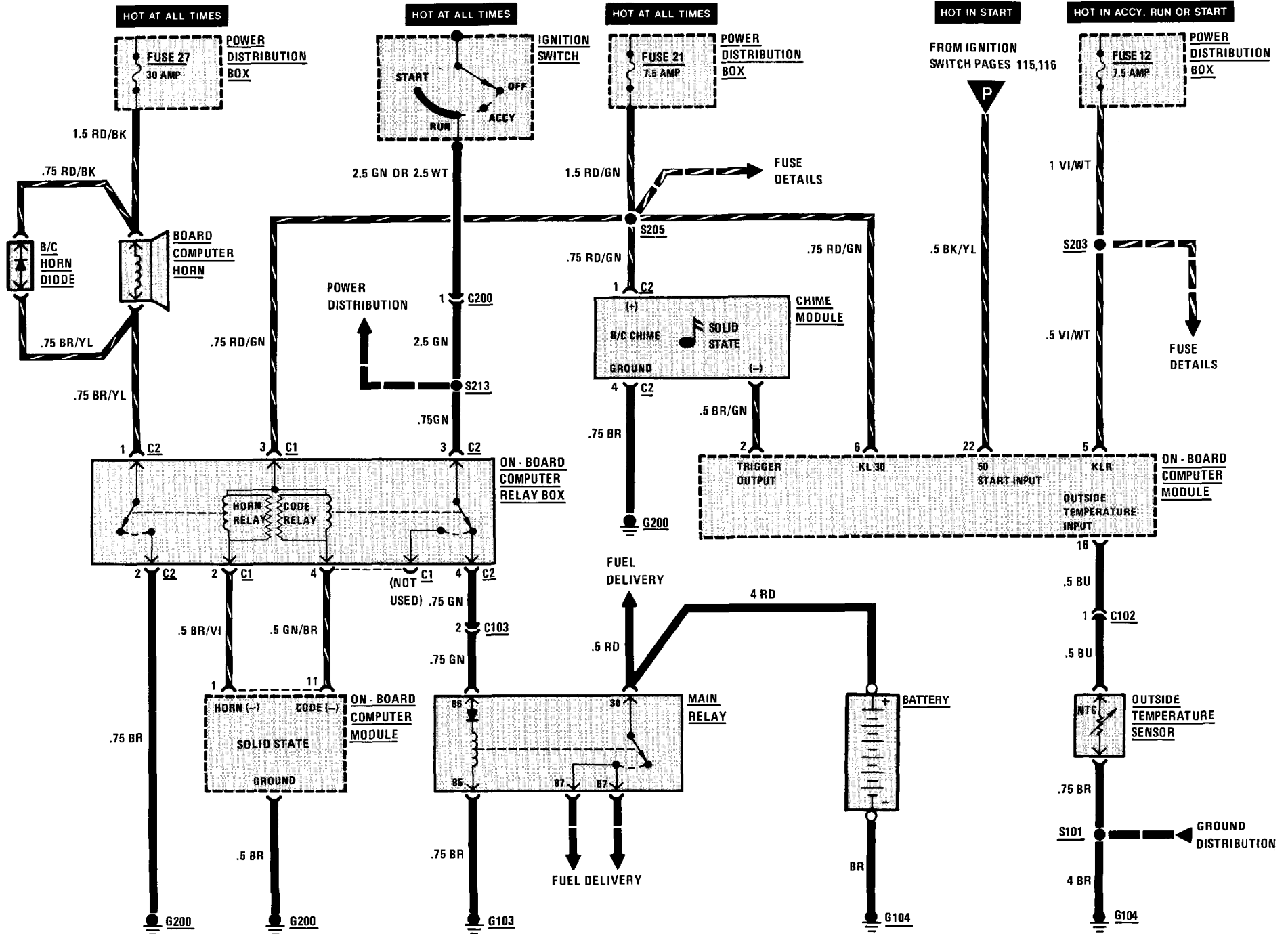

# 124 ON-BOARD COMPUTER

(For Component Locations See Page 208)

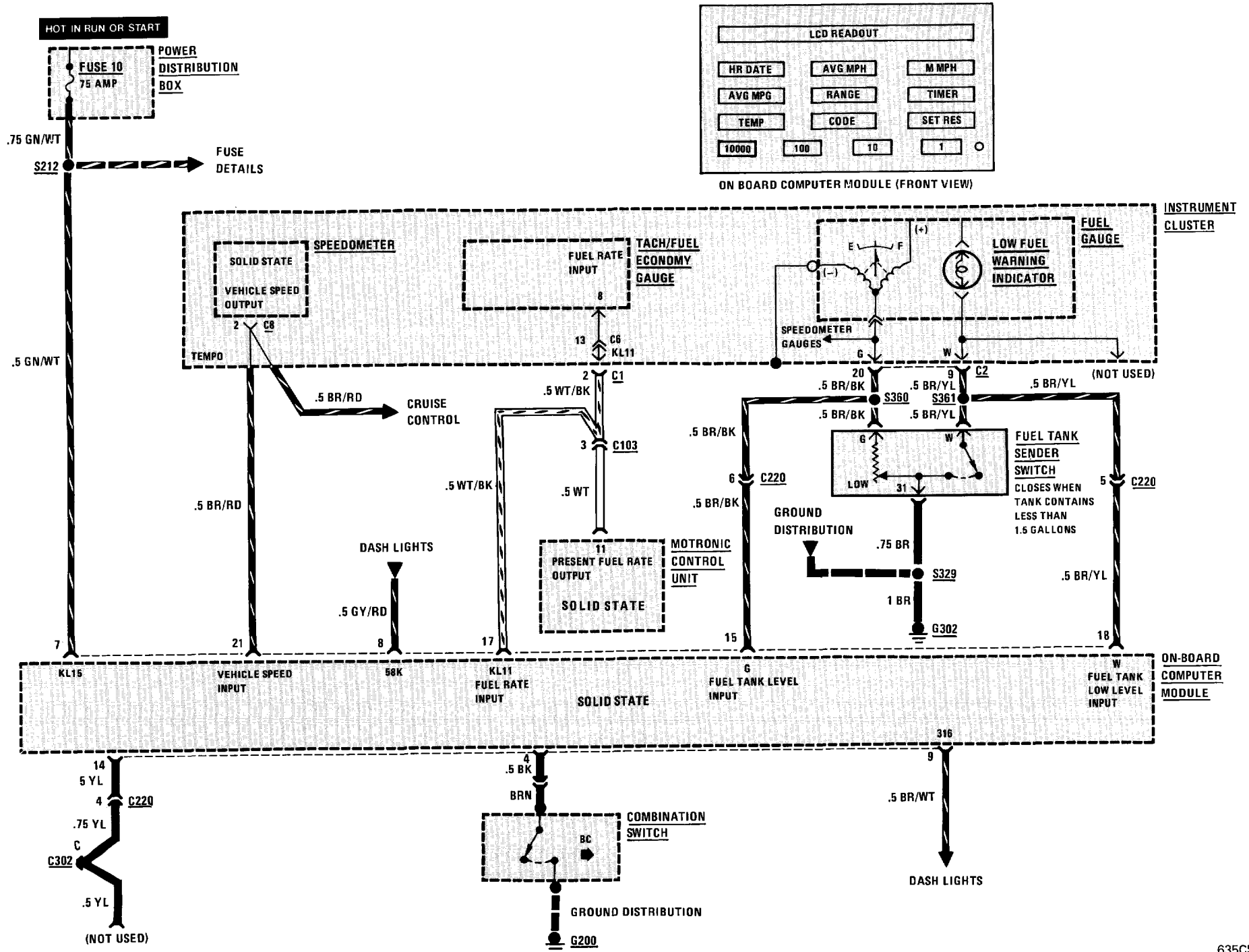

(For Component Locations See Page 210)

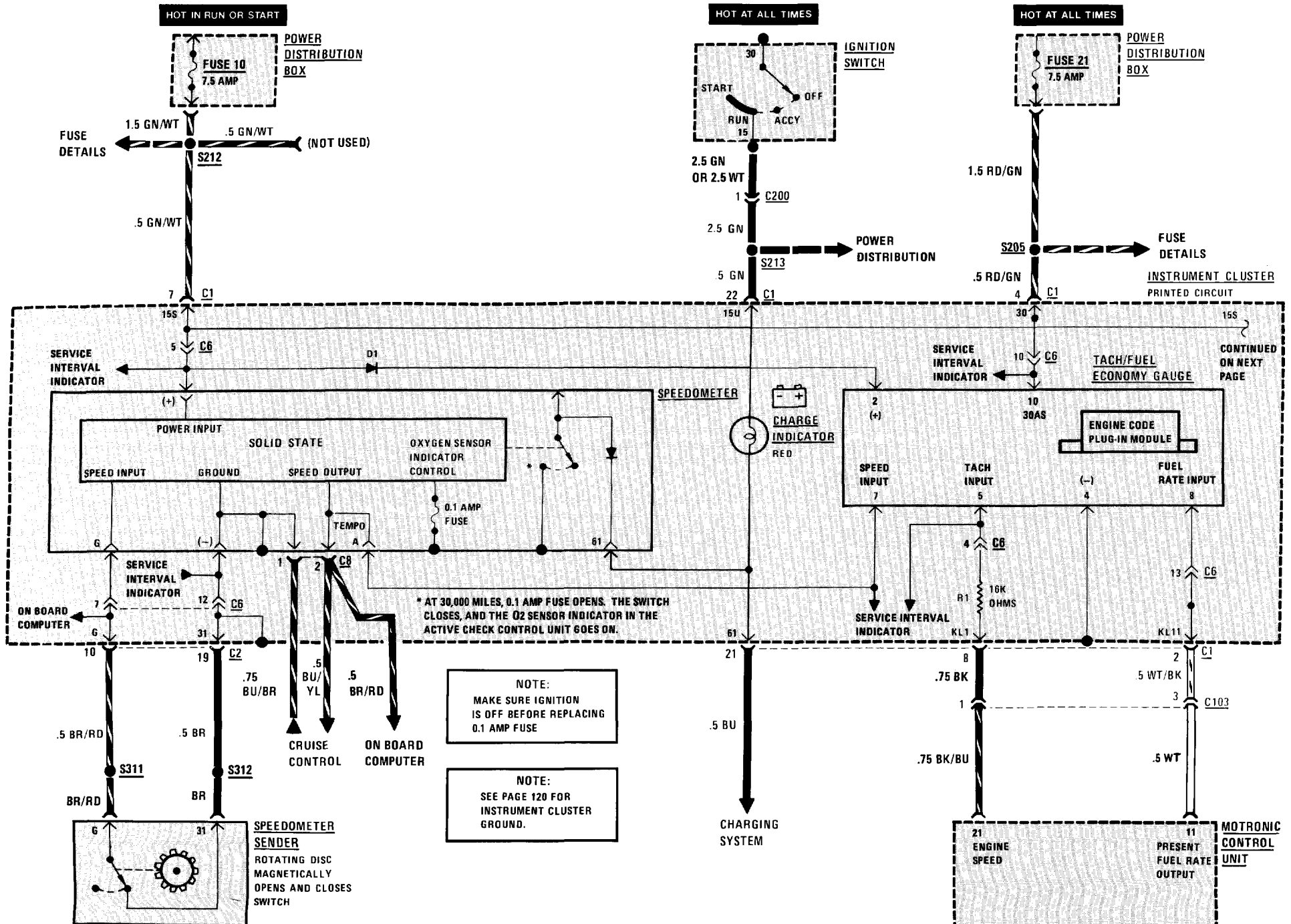

NOTE:  
MAKE SURE IGNITION  
IS OFF BEFORE REPLACING  
0.1 AMP FUSE

NOTE:  
SEE PAGE 120 FOR  
INSTRUMENT CLUSTER  
GROUND.

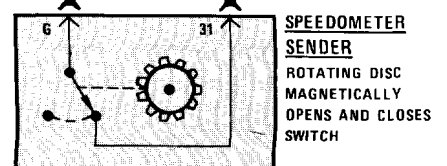

# 126 GAUGES/WARNING INDICATORS

(For Component Locations See Page 210)

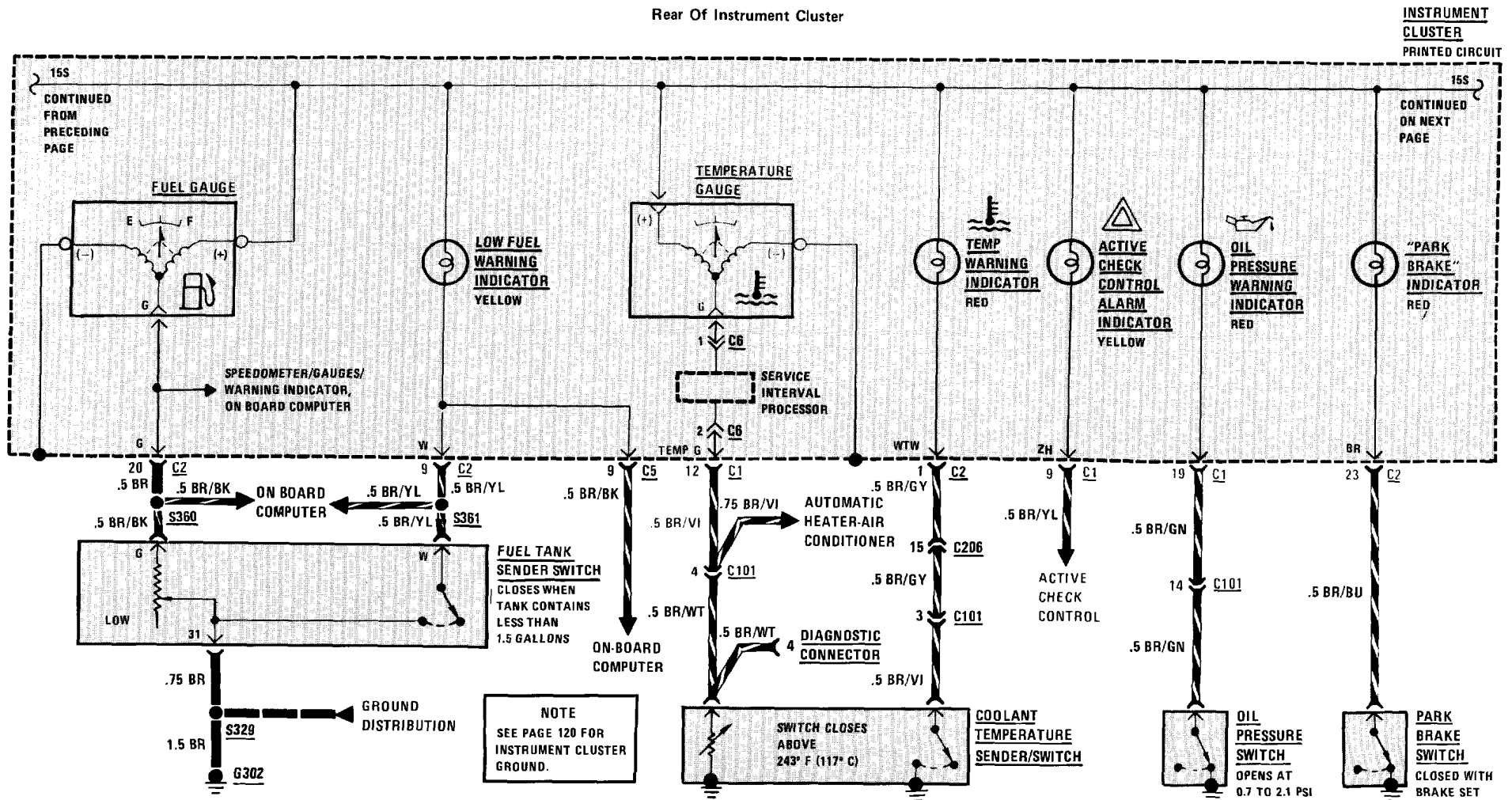
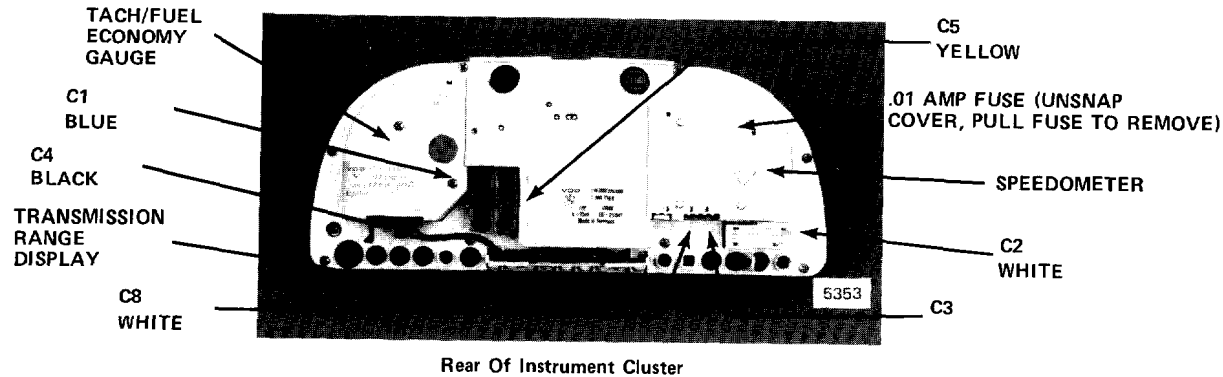

(For Component Locations See Page 210)

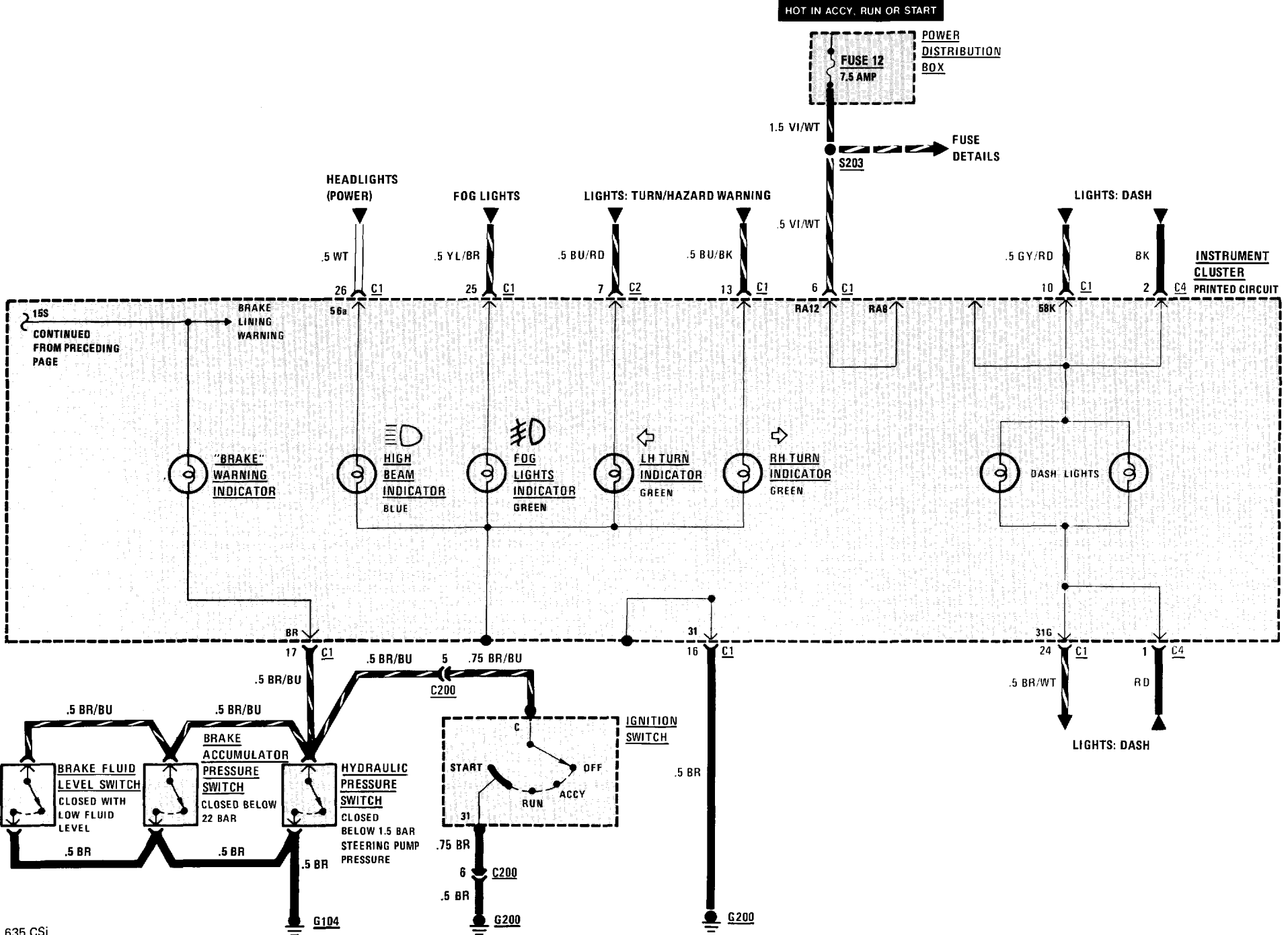

# 128 SERVICE INTERVAL INDICATOR

(For Component Locations See Page 210)

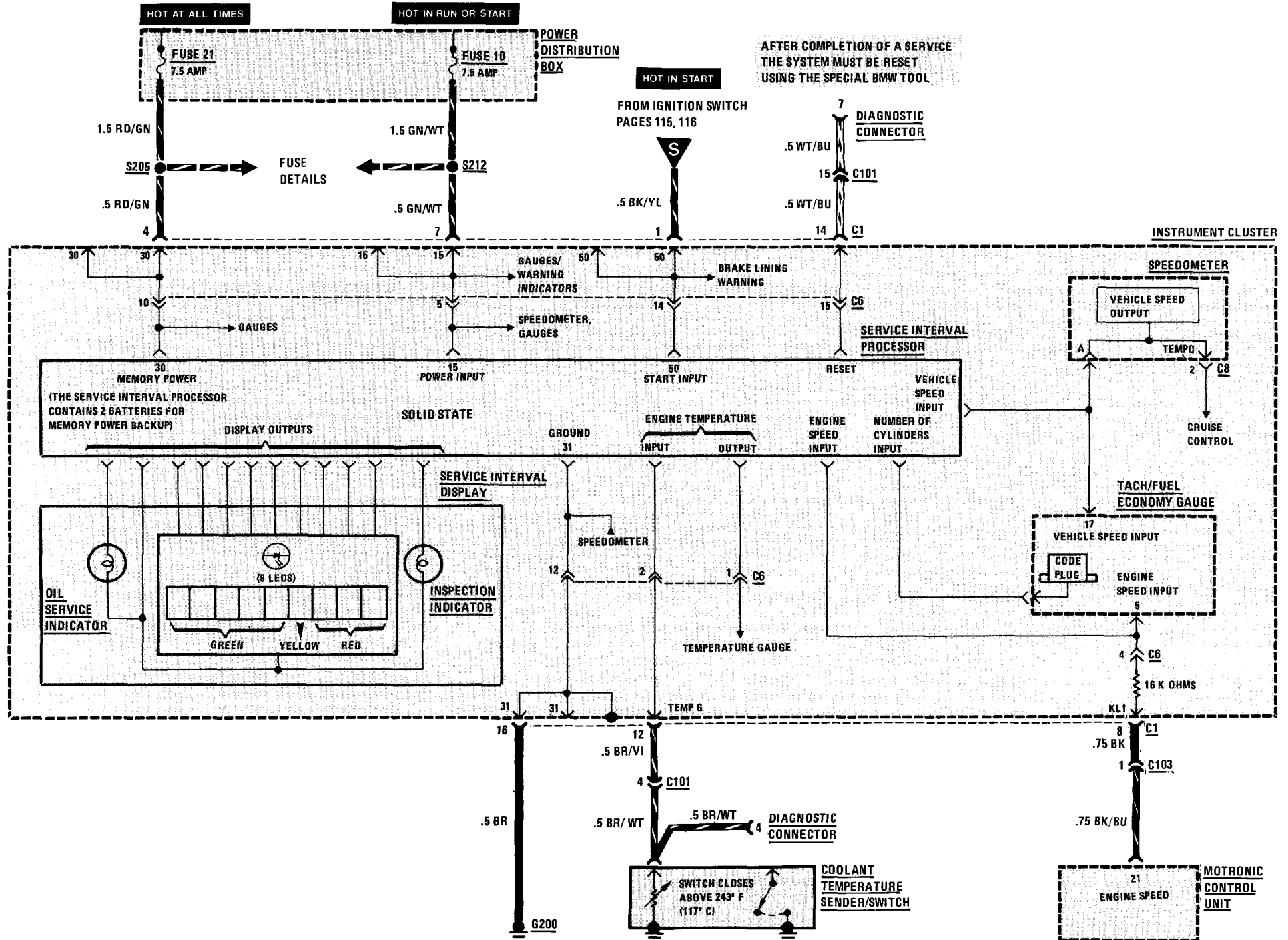

(For Component Locations See Page 212)

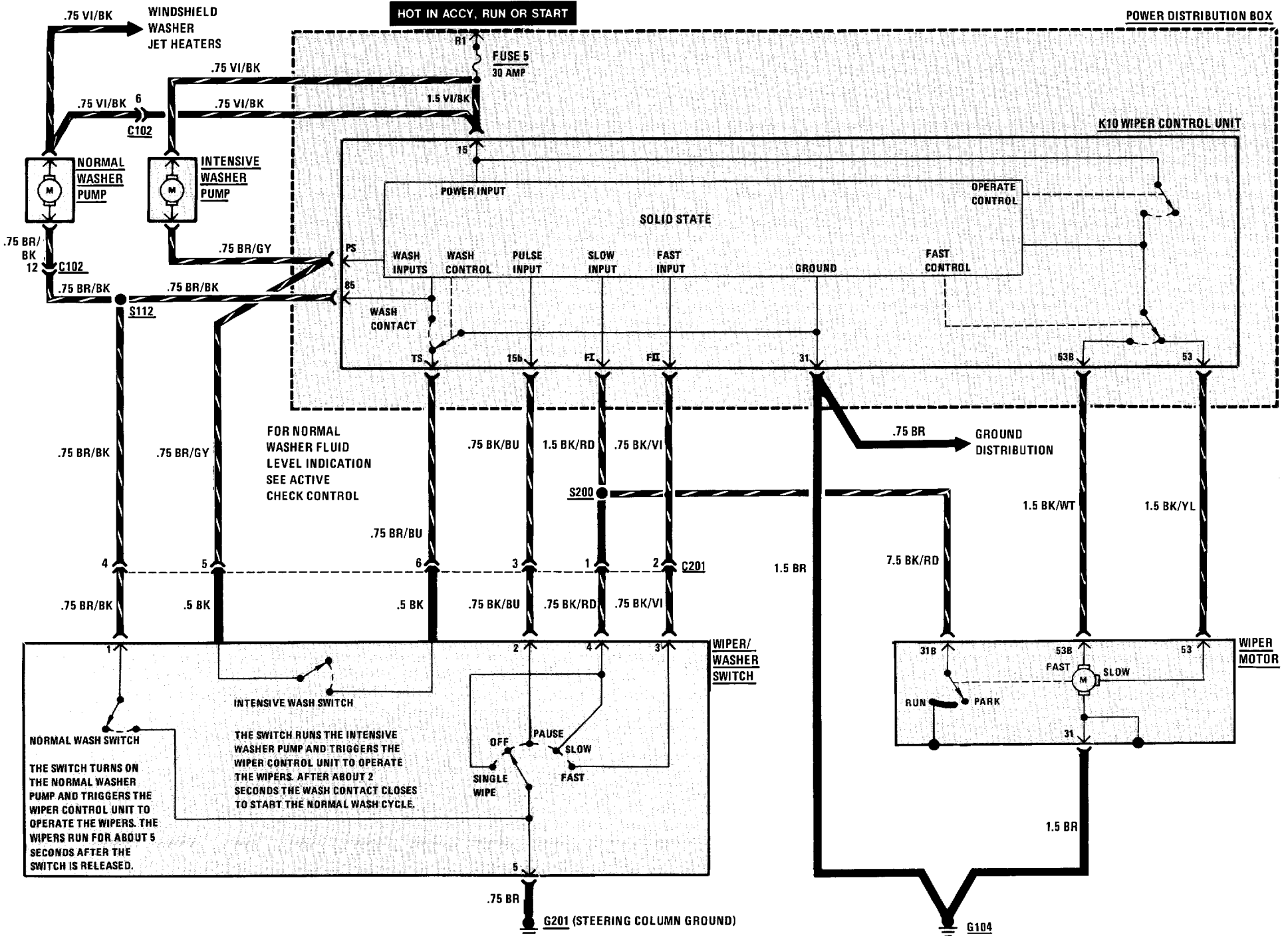



**ACTIVE CHECK CONTROL**

1. When the Ignition Switch is initially placed in "Run," the Active Check Control Arm Indicator flashes, and the Active Check Control Unit Brake Light LED and panel light illuminate for test purposes. Depressing the brake pedal clears the display.
2. When the Ignition Switch is placed in "Run," fault monitoring begins. To monitor the low beams, rear lights, or license lights, those circuits must be on. The brake lights are monitored only while the brake pedal is depressed.
3. When a fault occurs, the alarm indicator flashes, the appropriate LED fault indicator lights, and the panel light goes on for five seconds. Depressing the test button will clear the alarm indicator, but the LED fault indicator remains on.

4. To test the unit, depress the test button. The LED fault indicators and the panel lights should go on.

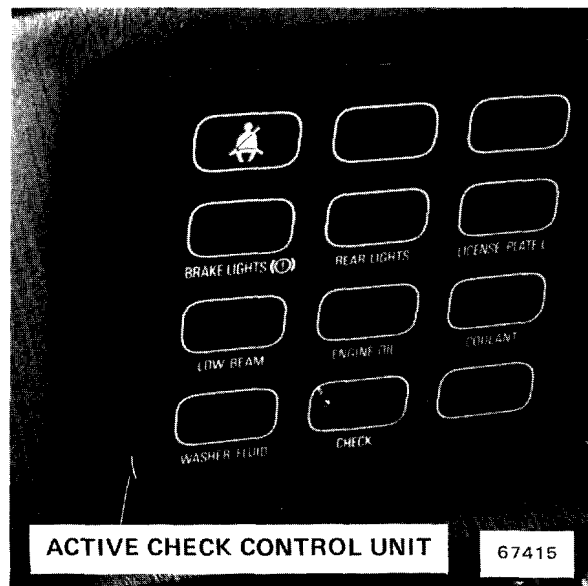
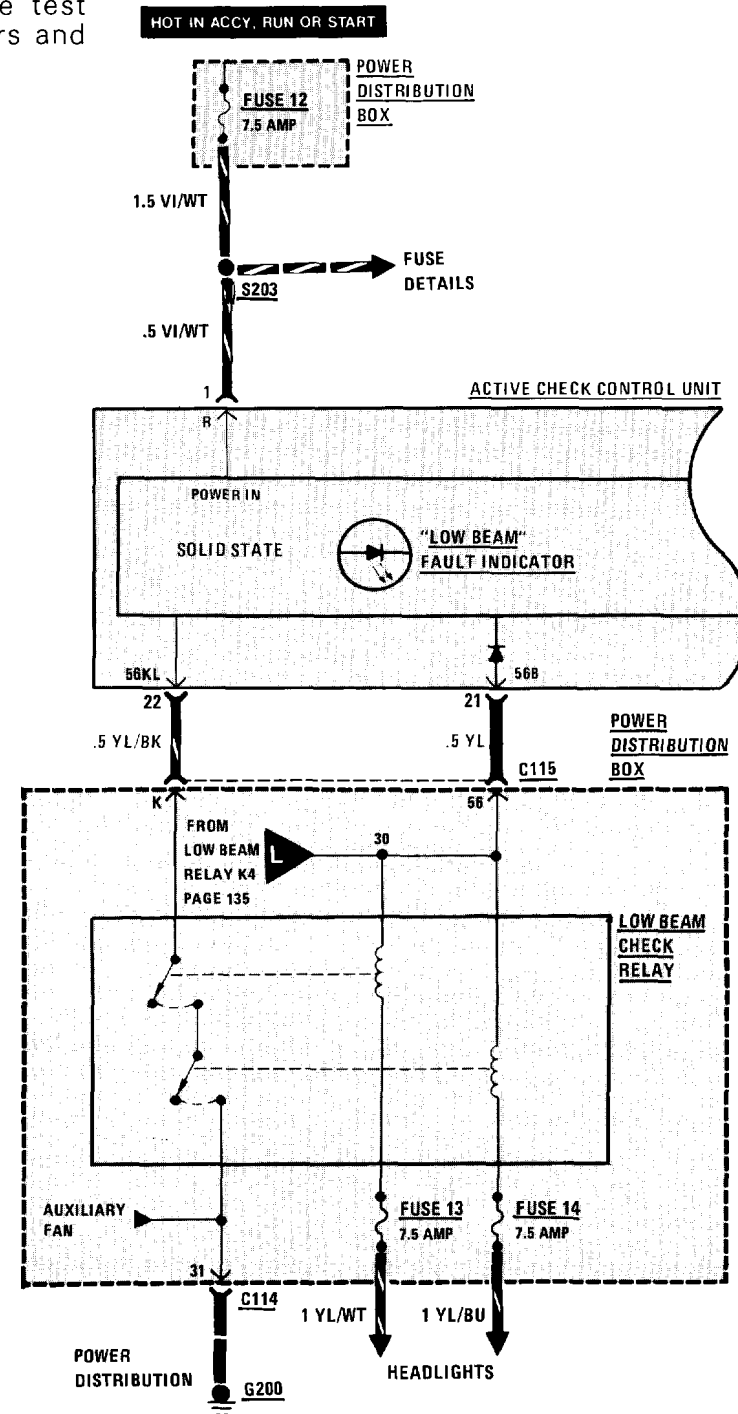
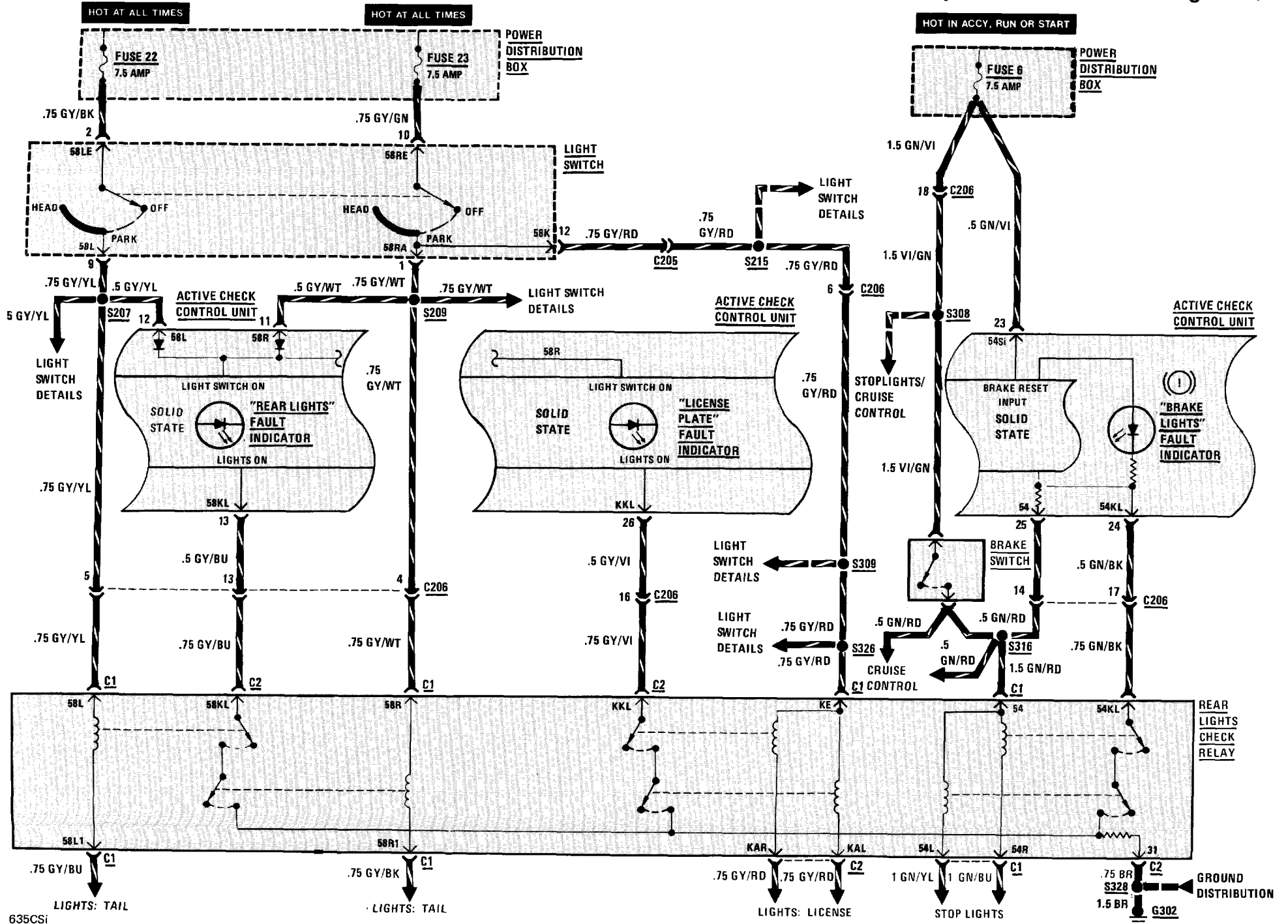

Figure 1 - Active Check Control Unit (Dash, Left Of Steering Column)



(For Component Locations See Page 201)



# 132 ACTIVE CHECK CONTROL

(For Component Locations See Page 201)

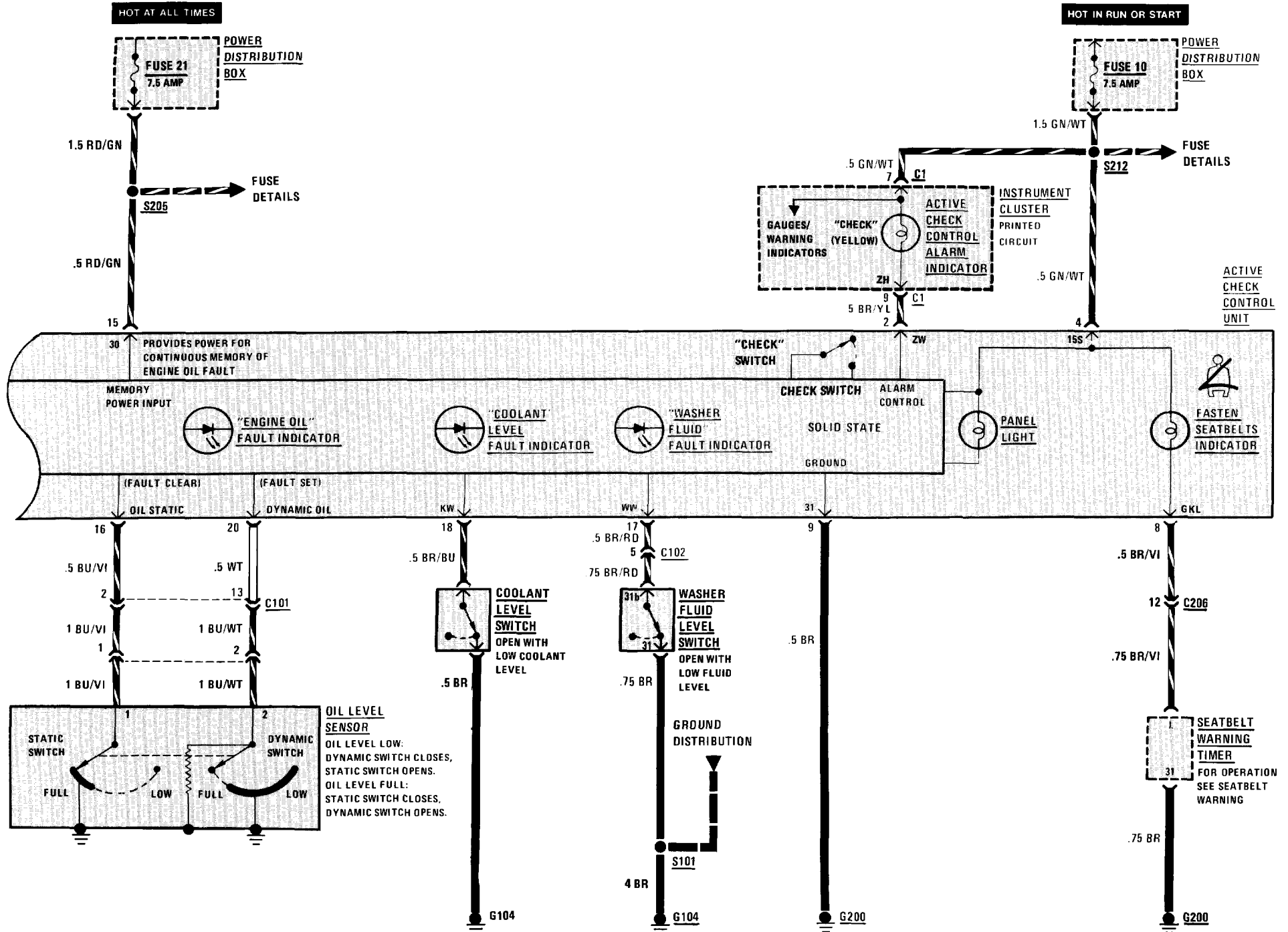

(For Component Locations See Page 202)

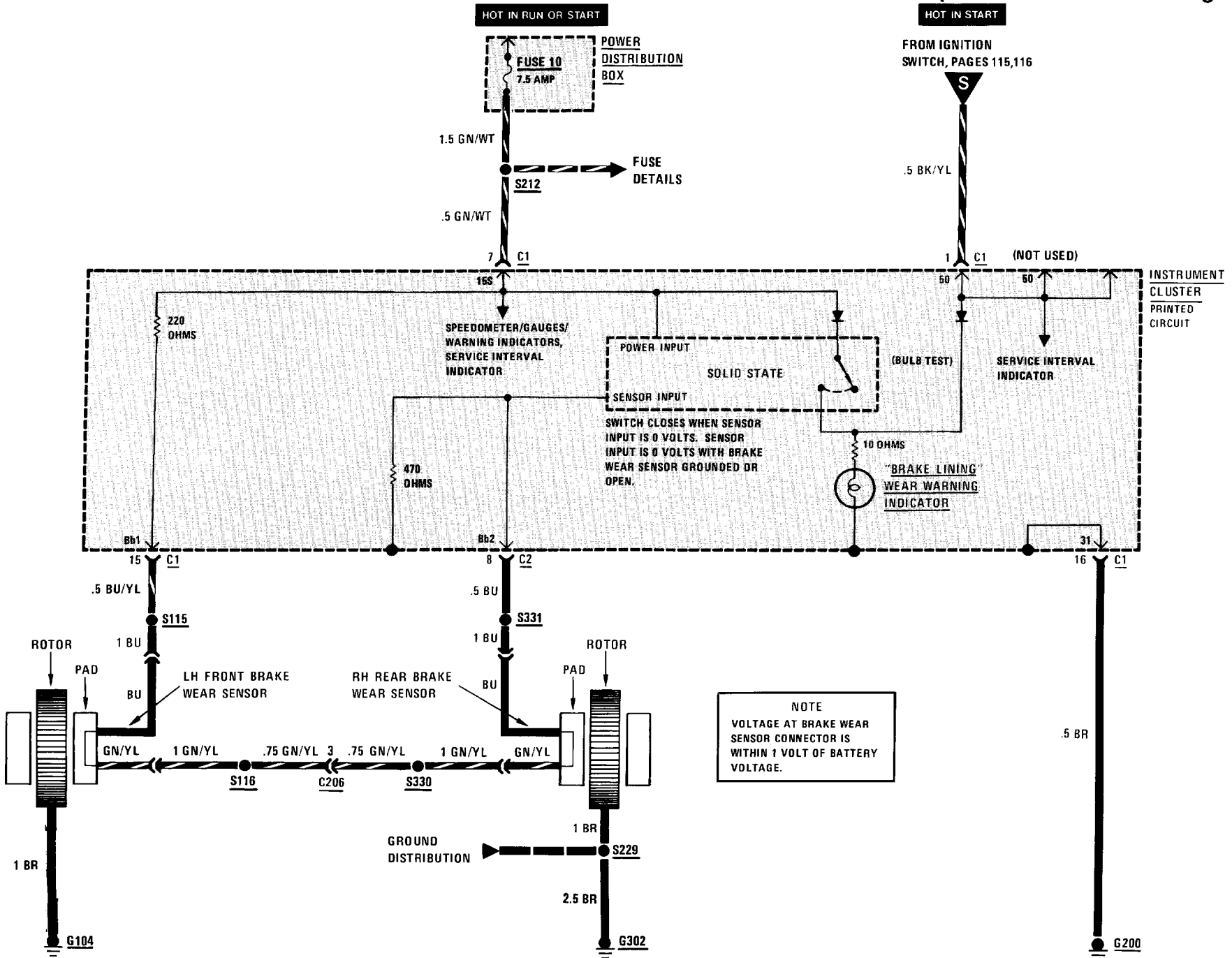

# 134 INTERIOR LIGHTS

(For Component Locations See Page 206)

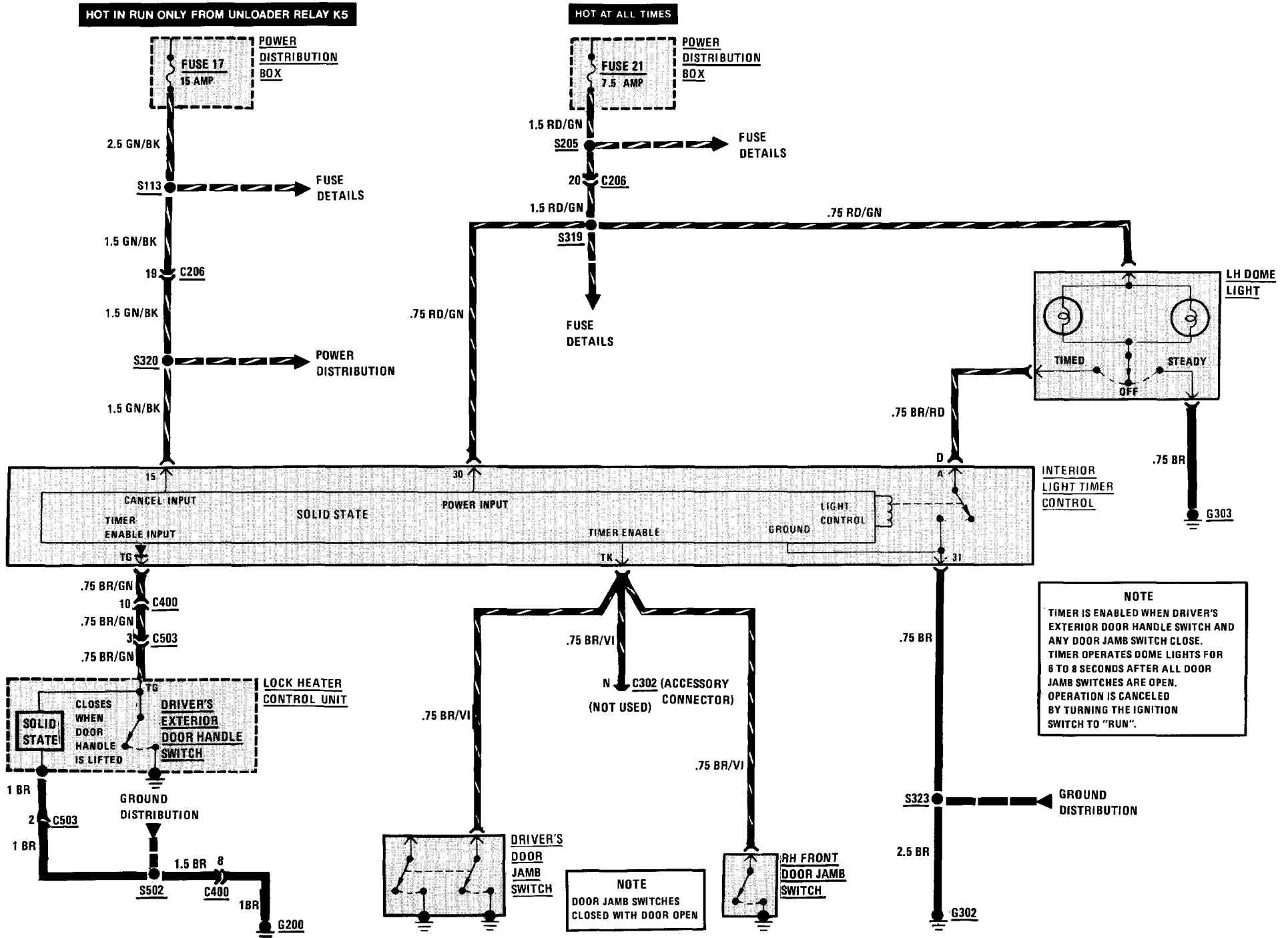

(For Component Locations See Page 203)

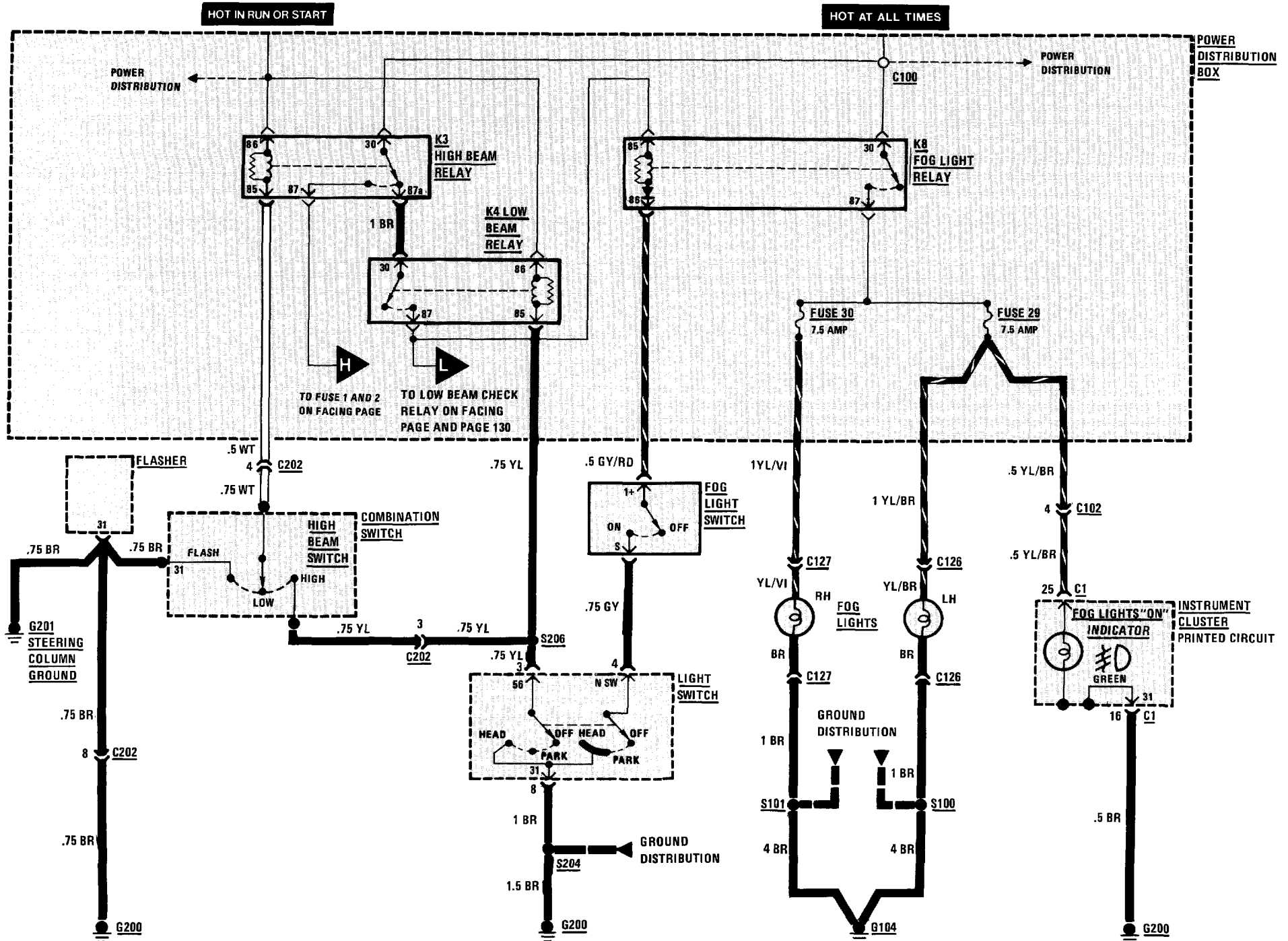

# 136 HEADLIGHTS (POWER)

(For Component Locations See Page 203)

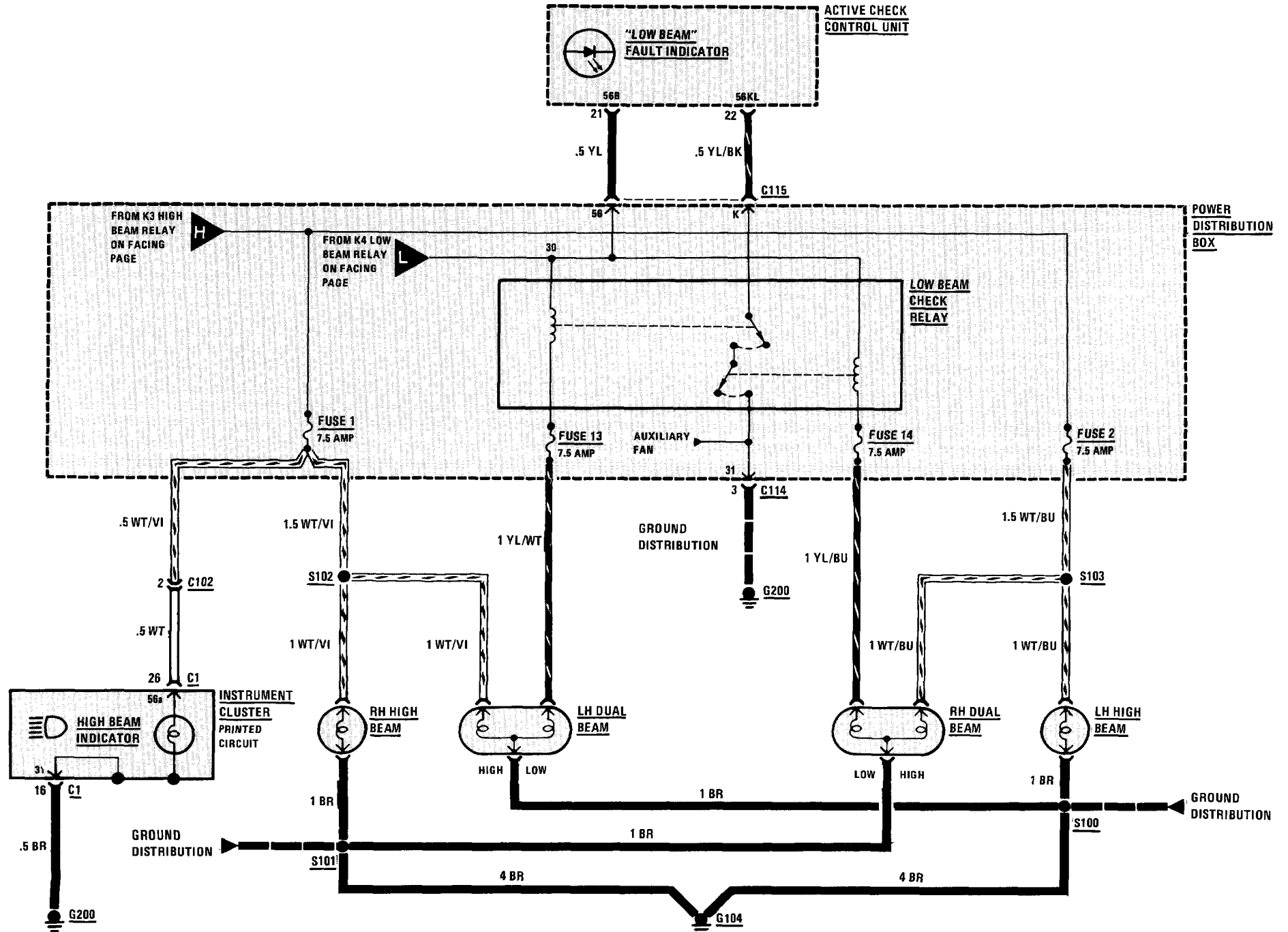

(For Component Locations See Page 207)

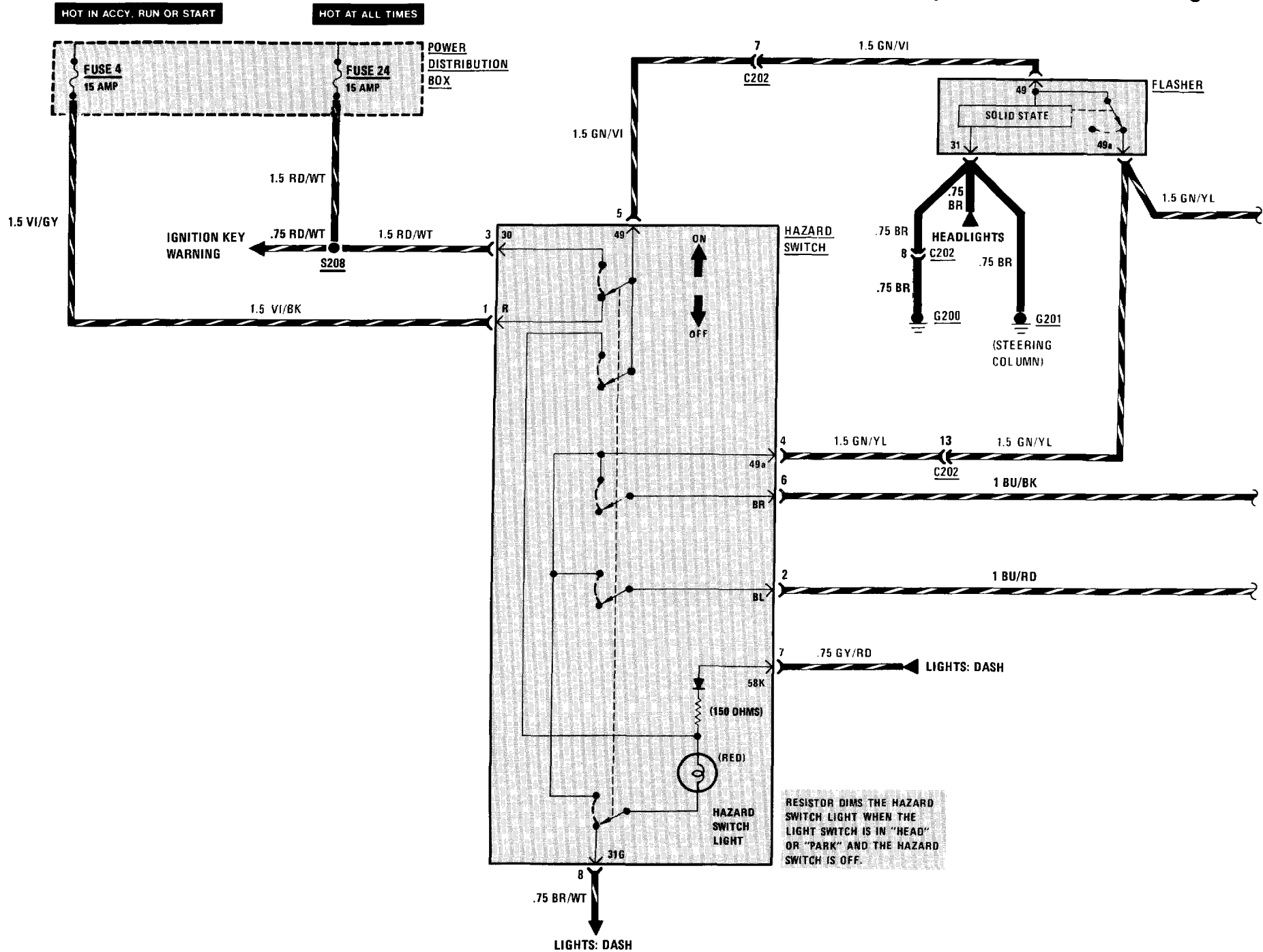



# 138 LIGHTS: TURN/HAZARD WARNING

(For Component Locations See Page 207)

CONTINUED FROM PREVIOUS PAGE

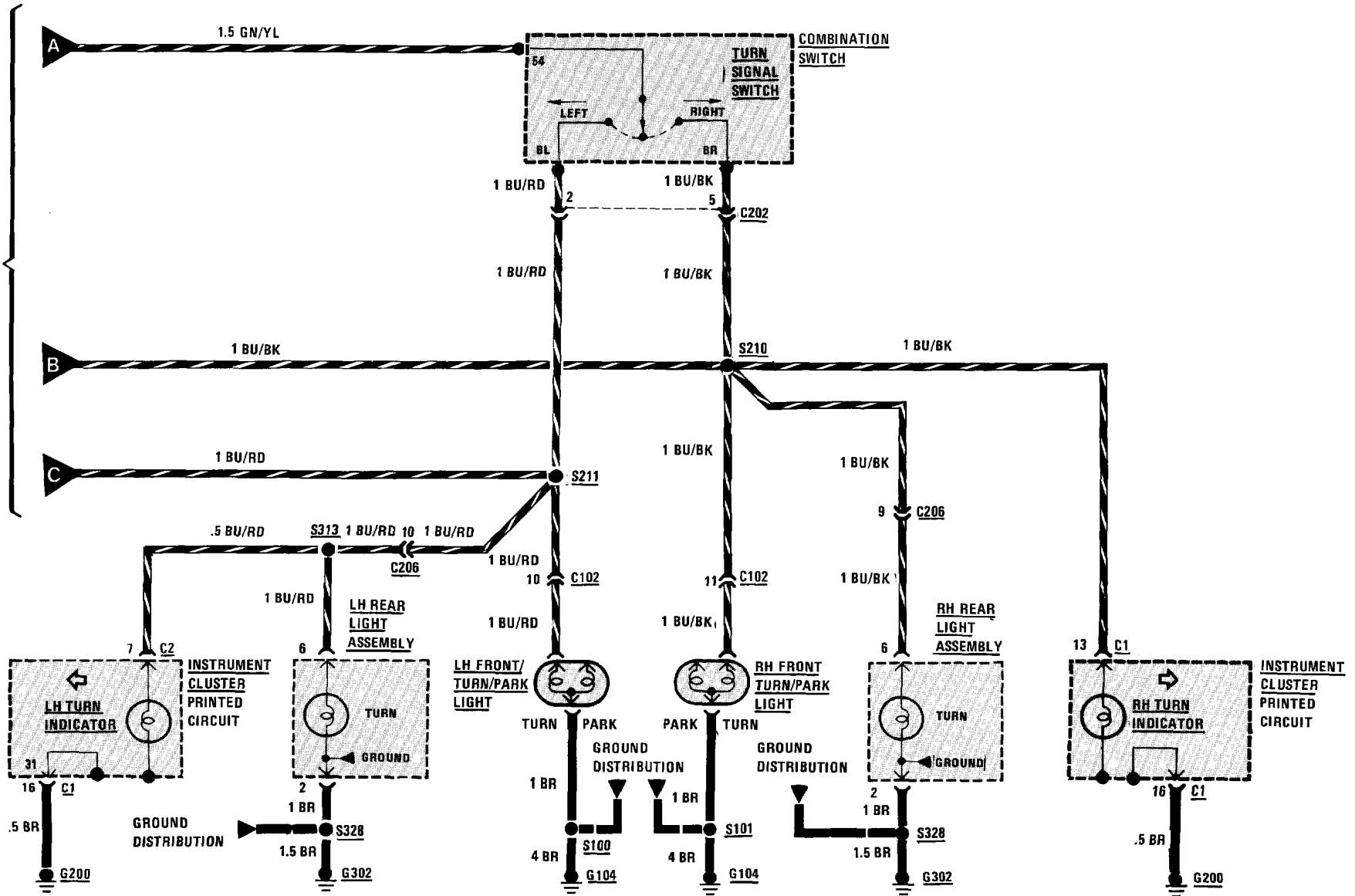

(For Component Locations See Page 206)

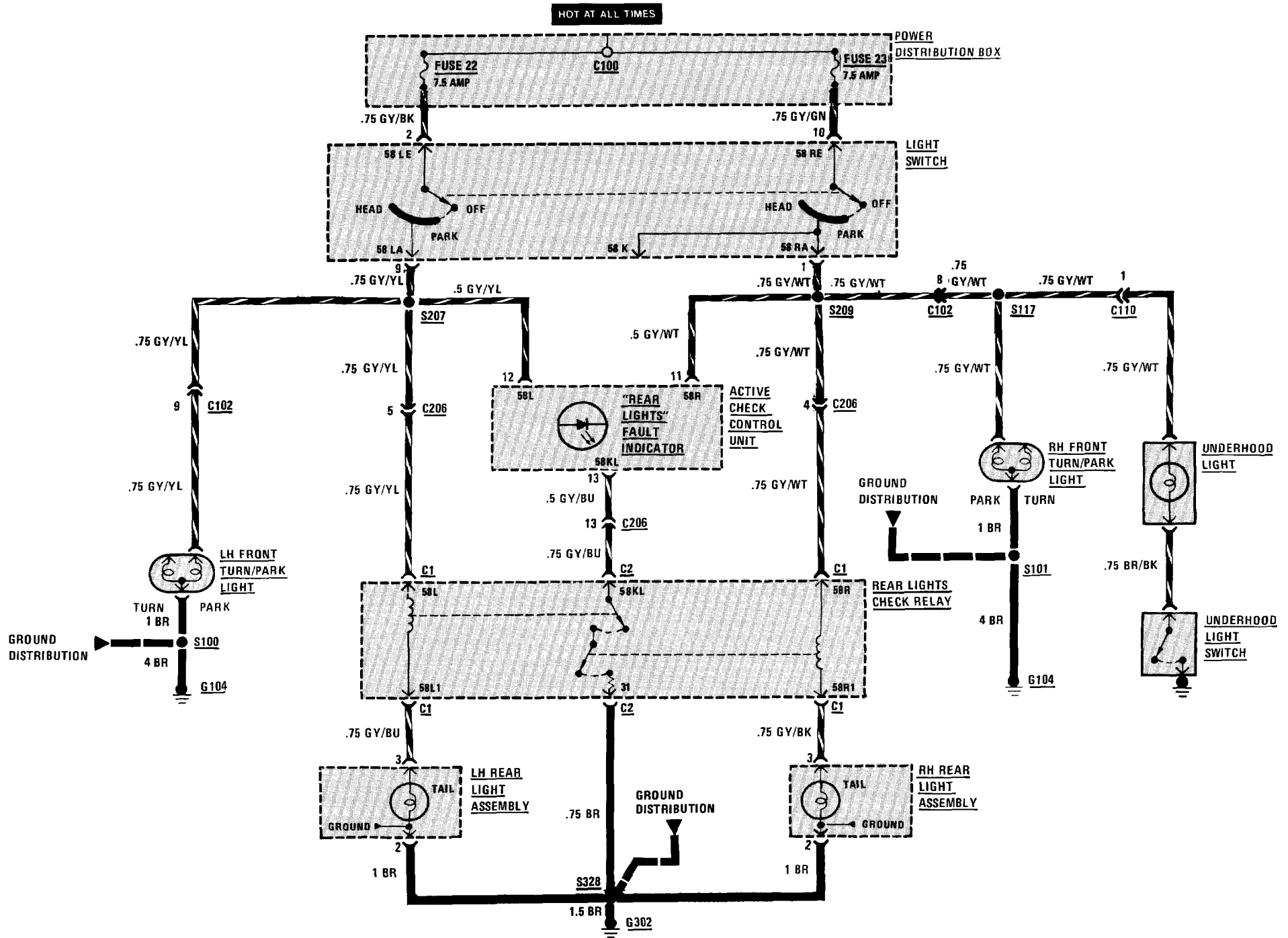

# 140 LIGHTS: REAR MARKER LICENSE

(For Component Locations See Page 207)

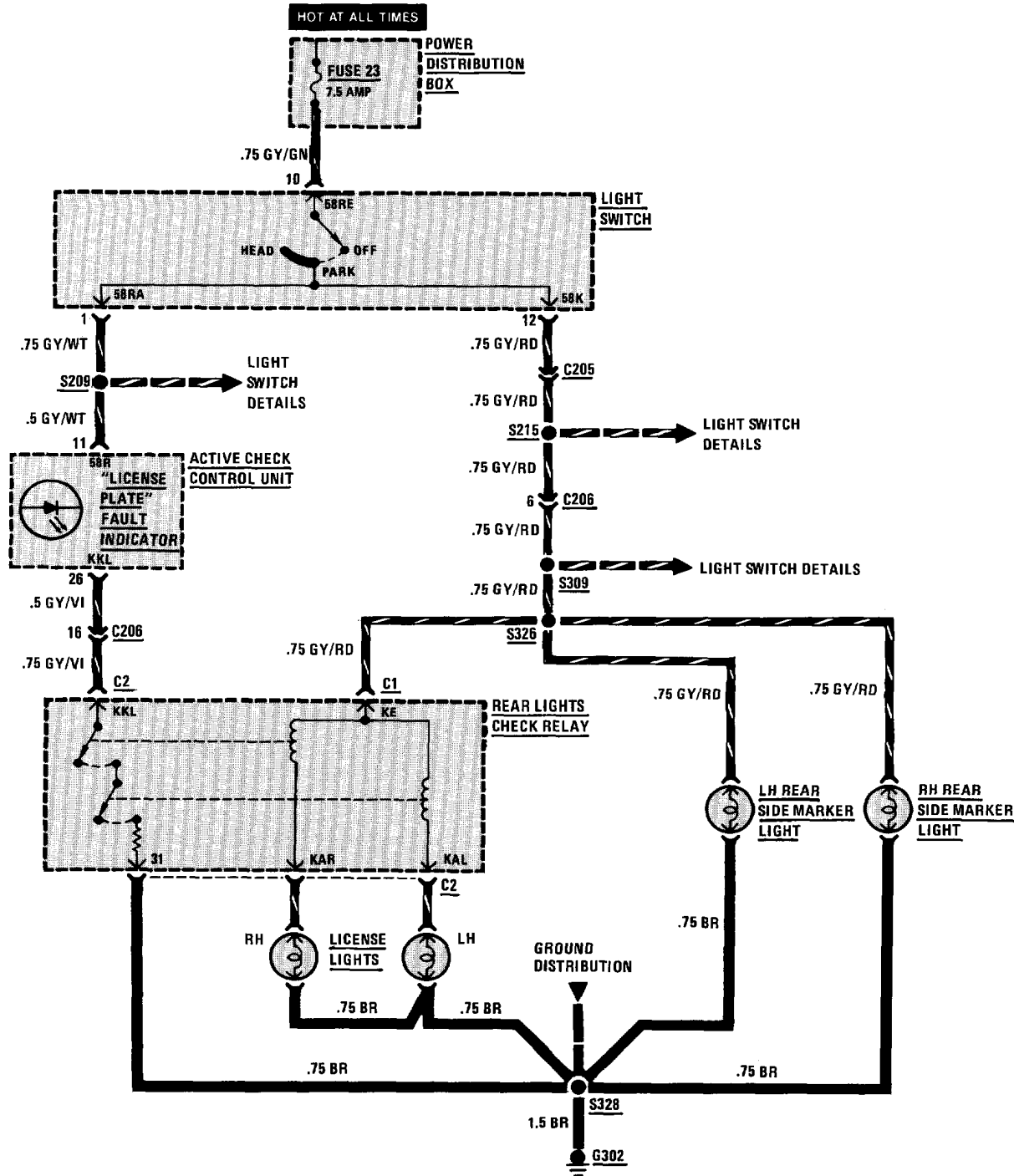

# TRUNK LIGHT

(For Component Locations See Page 207)

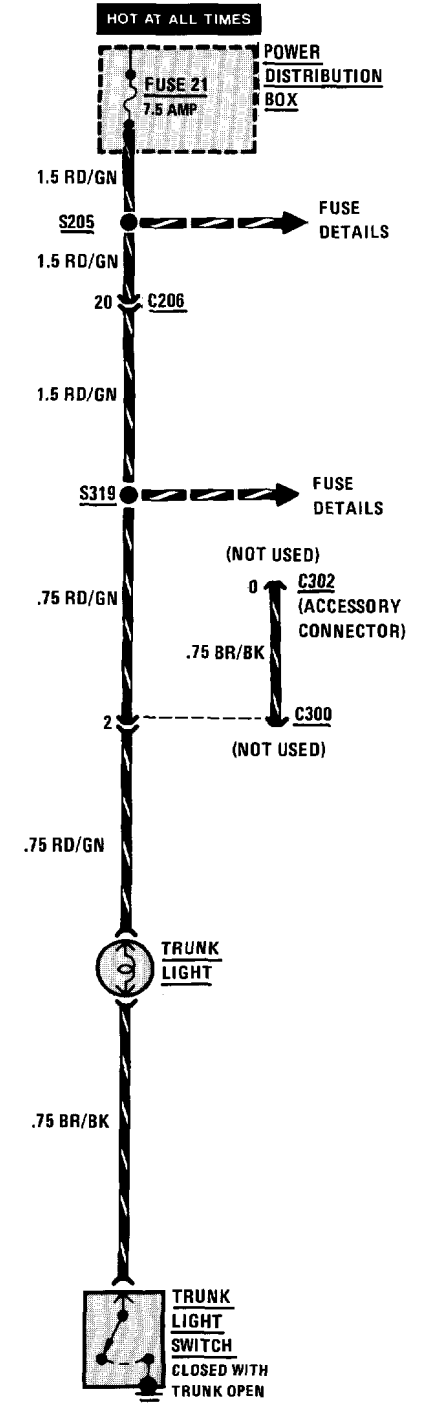

(For Component Locations See Page 211)

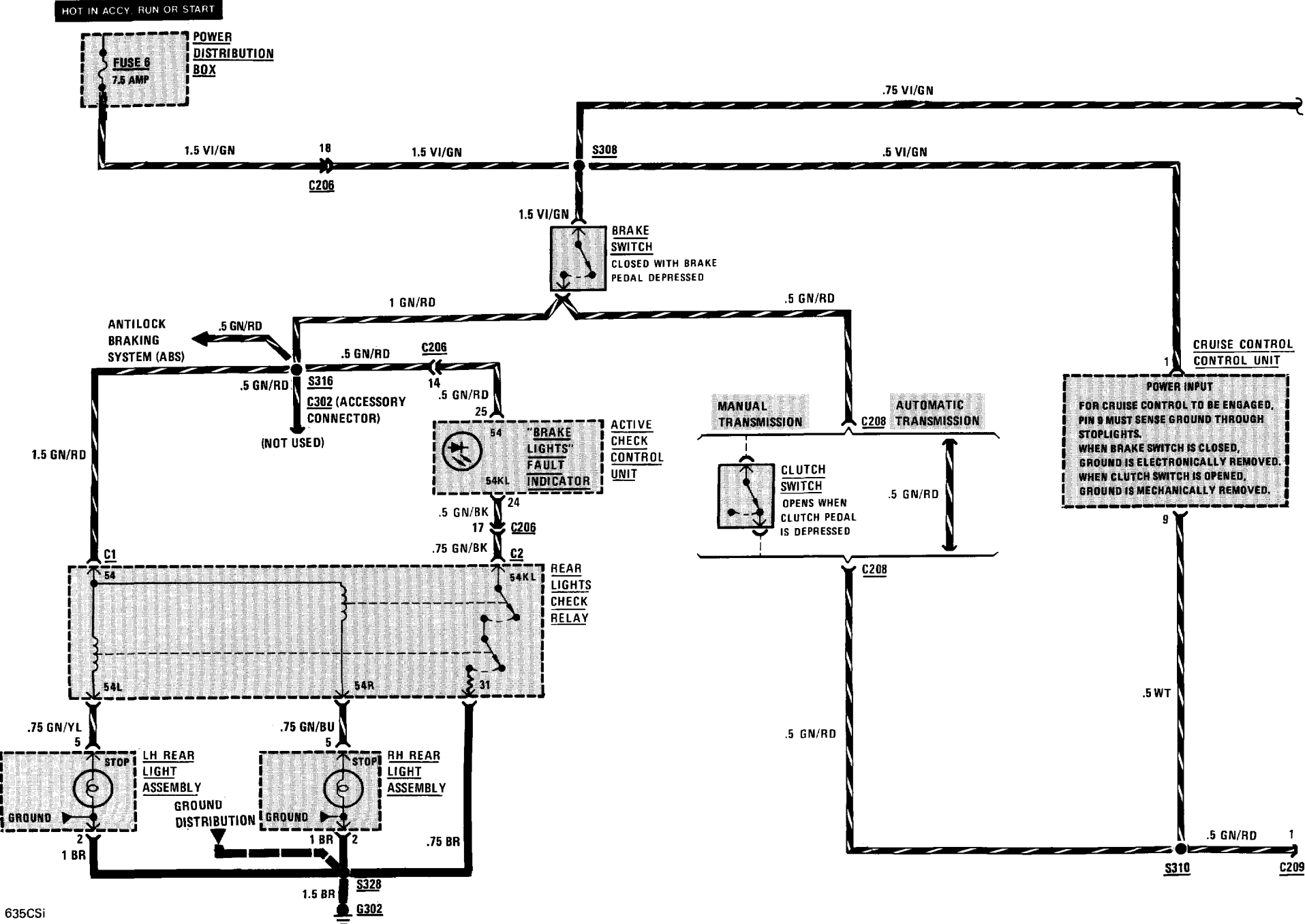

# 142 STOPLIGHTS/CRUISE CONTROL

(For Component Locations See Page 211)

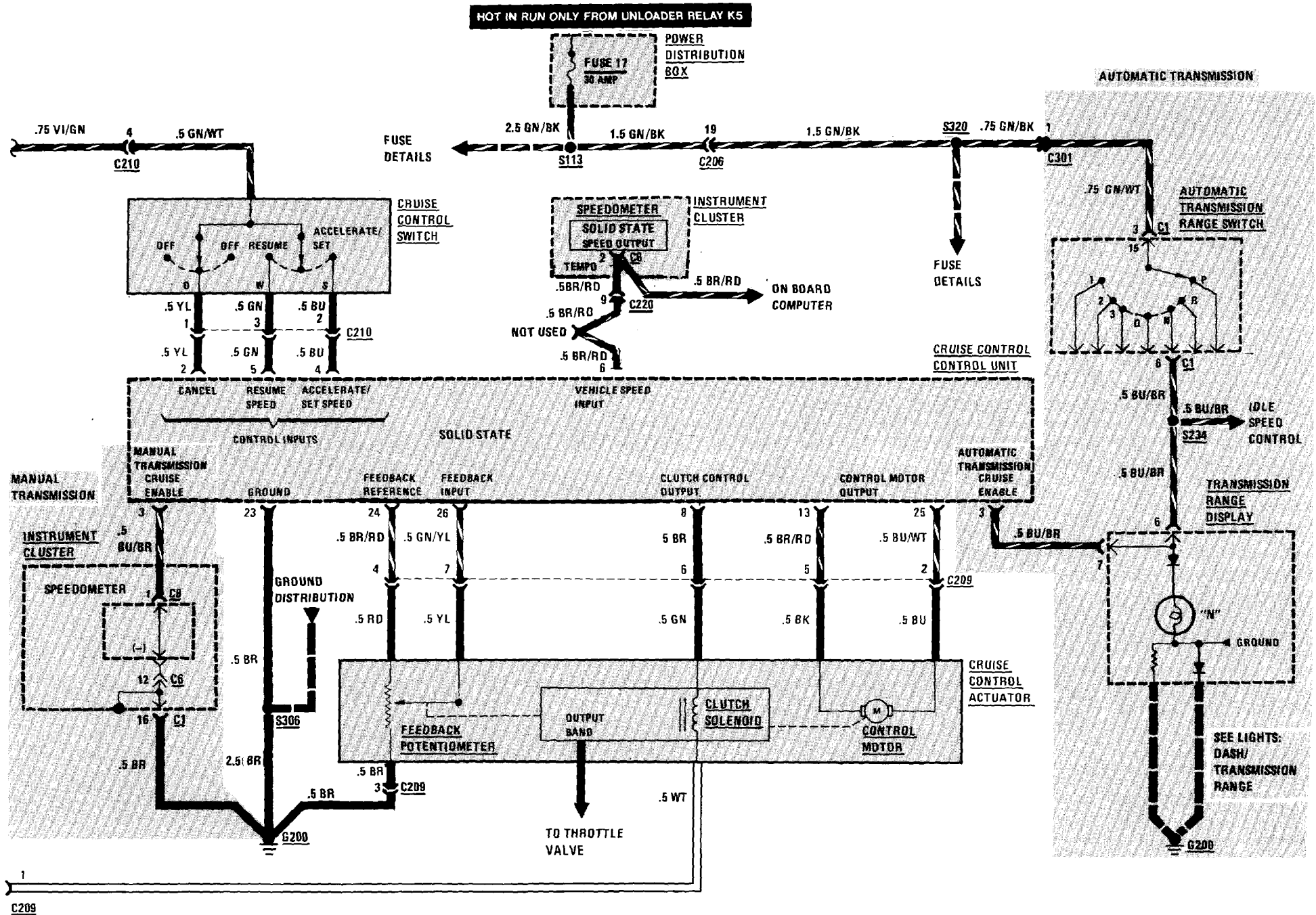

# LIGHTS: DASH/TRANSMISSION RANGE/RH VISOR 143

(For Component Locations See Page 207)

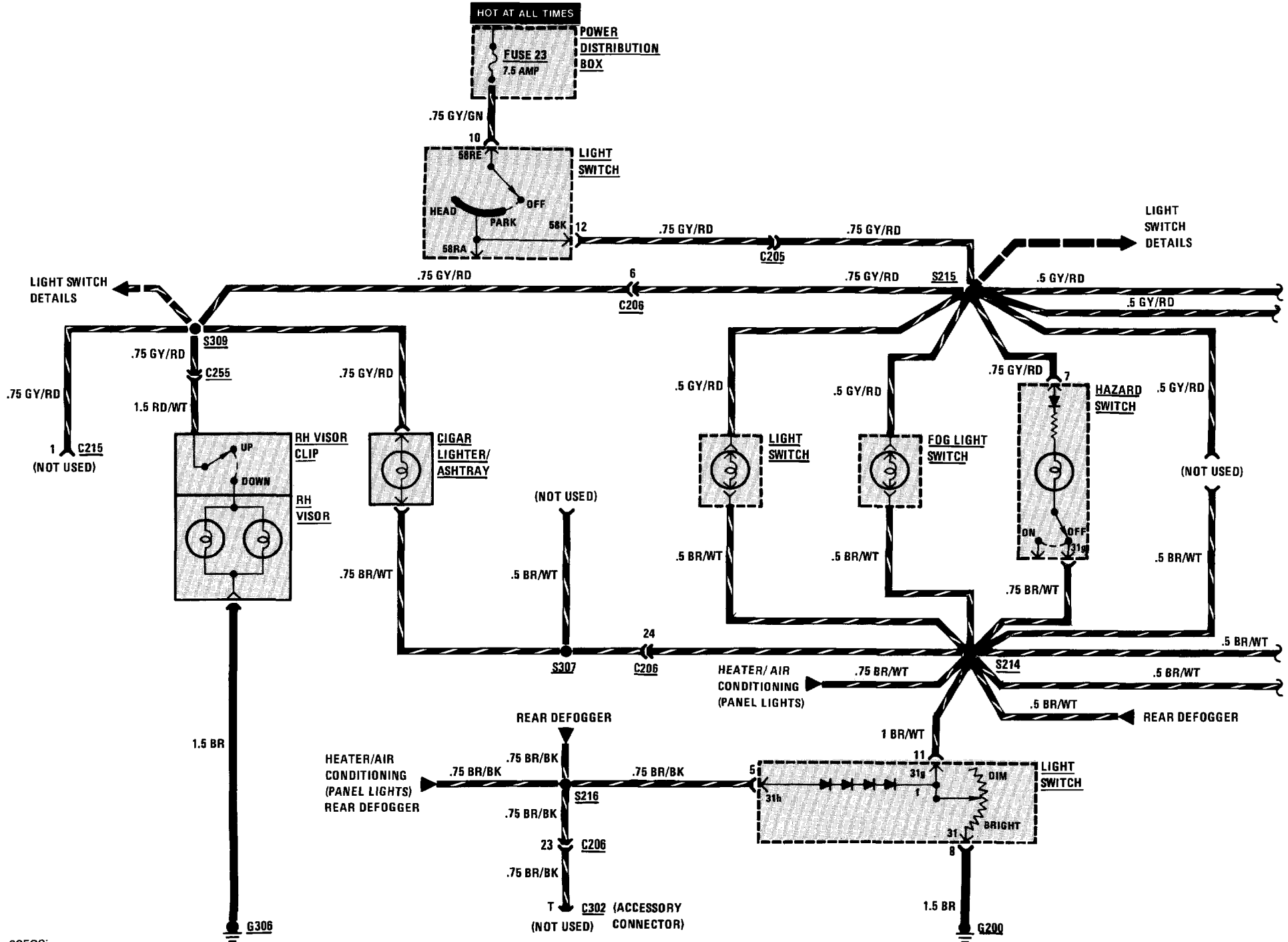

# 144 LIGHTS: DASH/TRANSMISSION RANGE

(For Component Locations See Page 207)

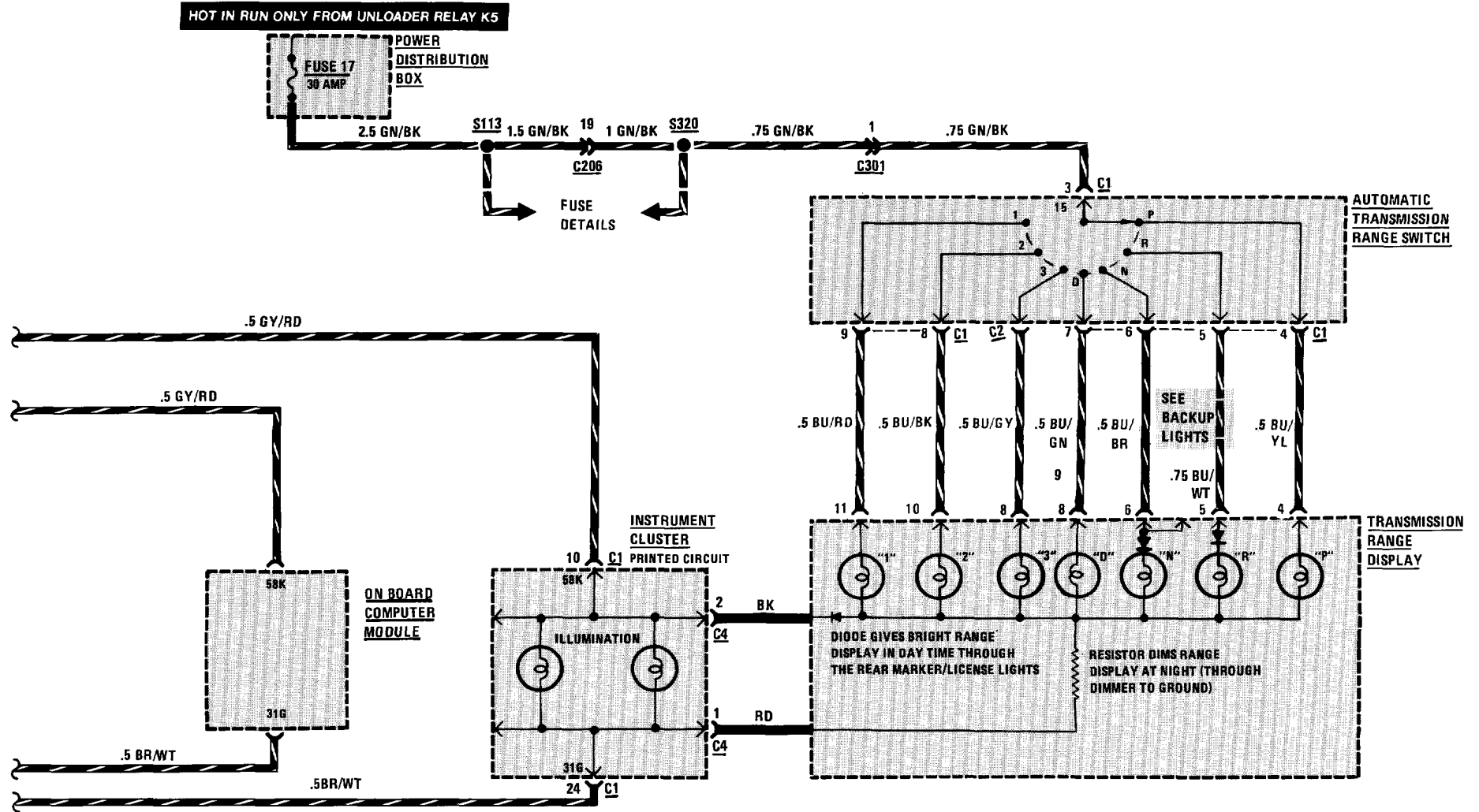

(For Component Locations See Page 201)

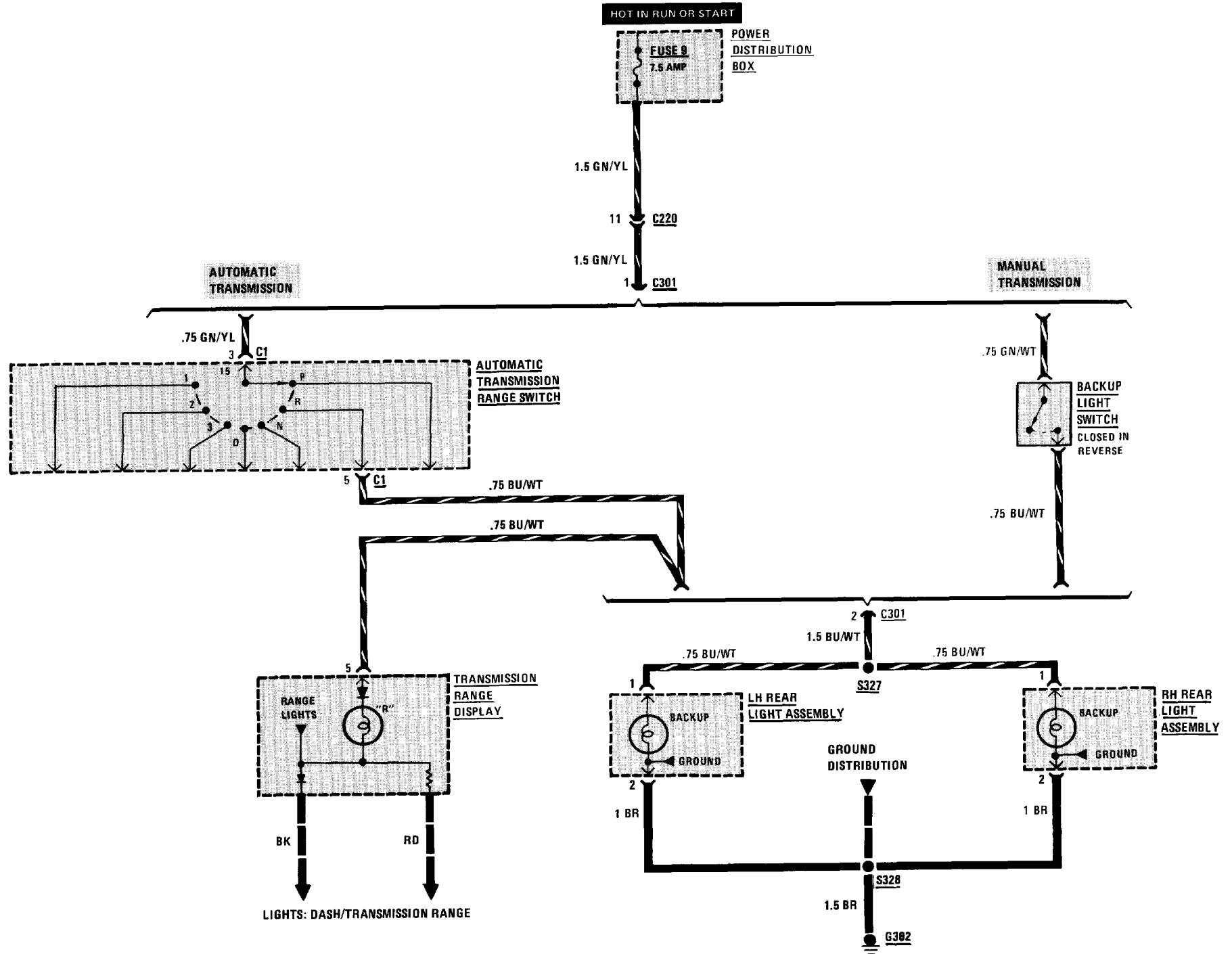



# 146 CIGAR LIGHTER/GLOVE BOX LIGHT/AUTO-CHARGING FLASHLIGHT

(For Component Locations See Page 202)

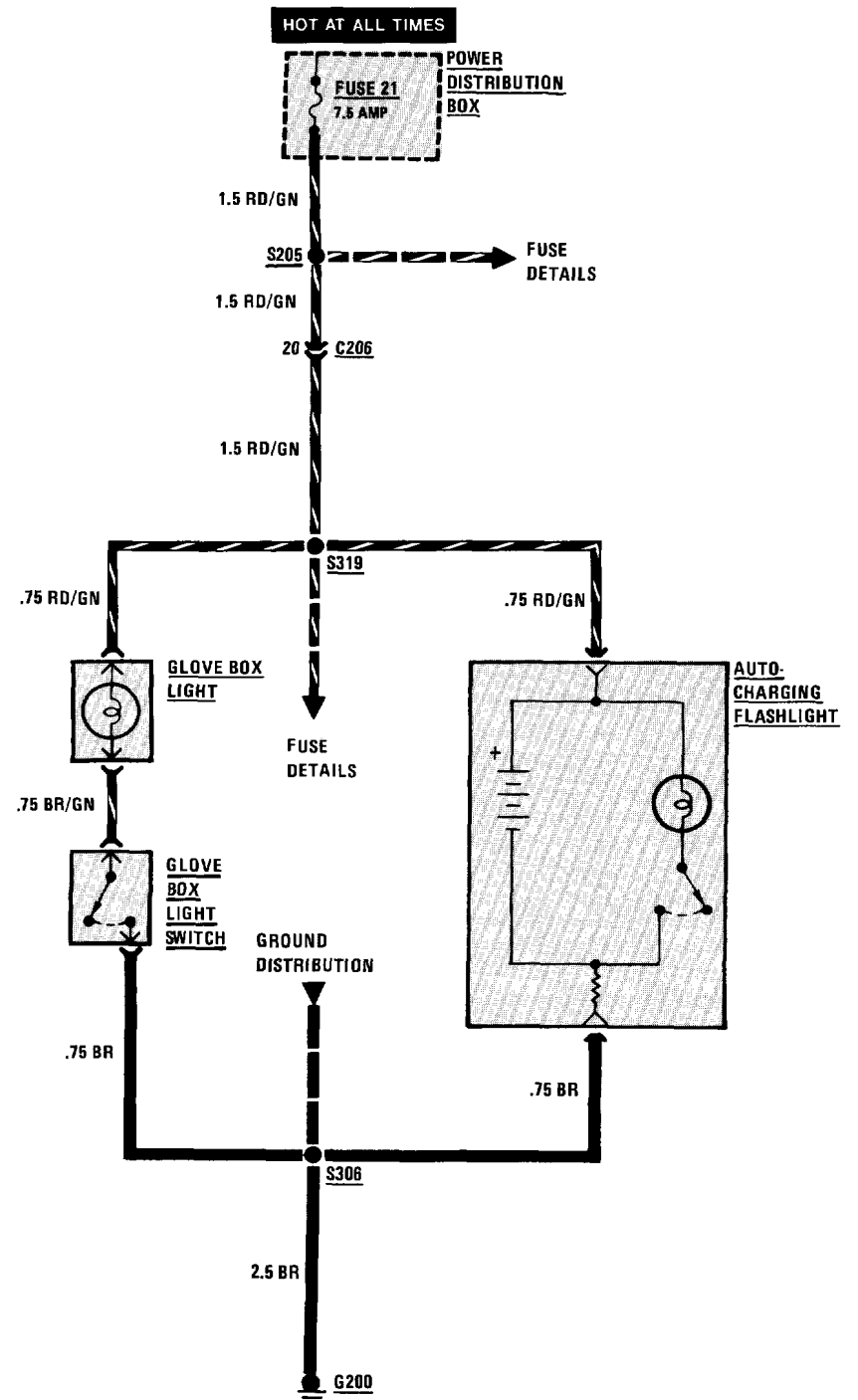
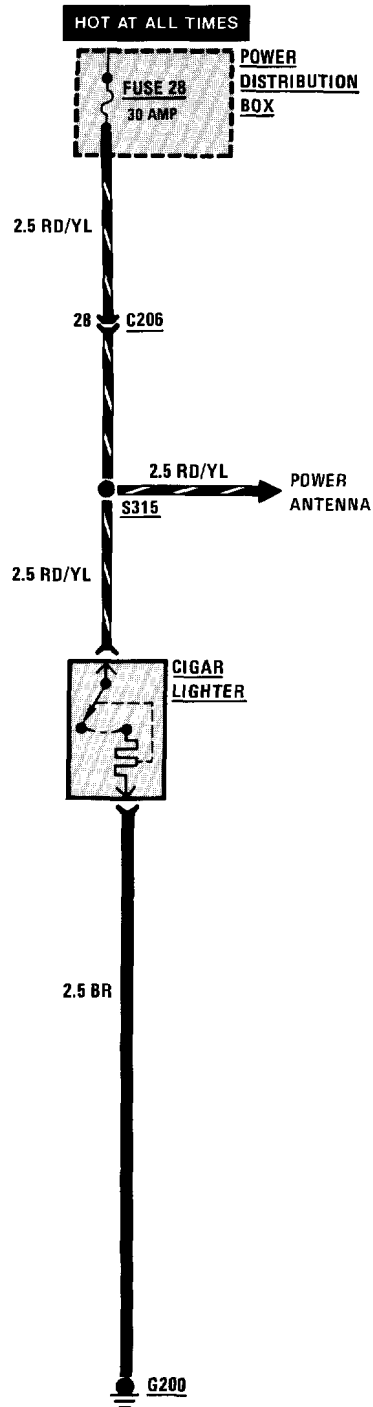

(For Component Locations See Page 204)

(For Component Locations See Page 204)

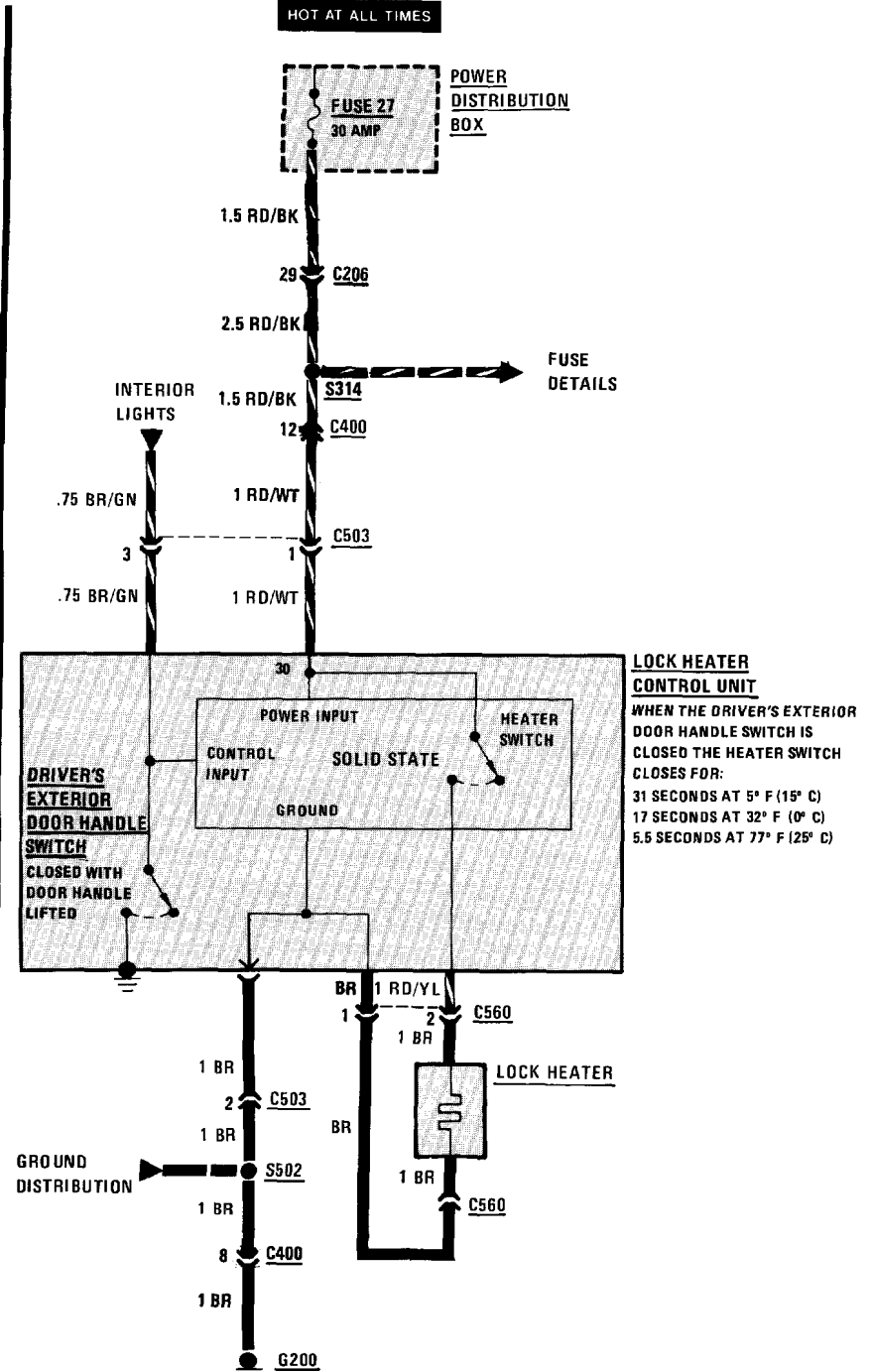
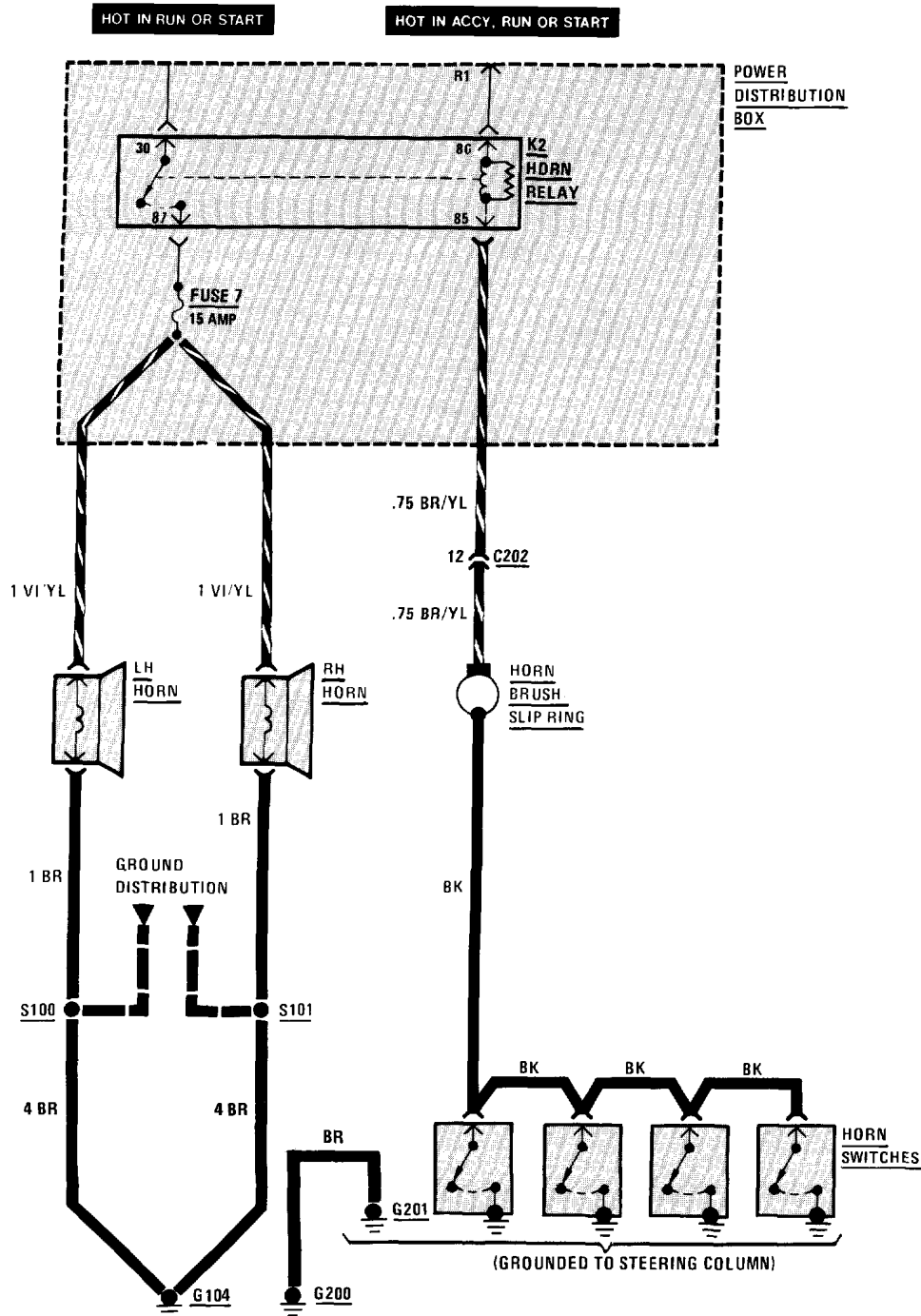

**LOCK HEATER CONTROL UNIT**

WHEN THE DRIVER'S EXTERIOR DOOR HANDLE SWITCH IS CLOSED THE HEATER SWITCH CLOSSES FOR:

- 31 SECONDS AT 5° F (15° C)
- 17 SECONDS AT 32° F (0° C)
- 5.5 SECONDS AT 77° F (25° C)

# 148 REAR DEFOGGER

(For Component Locations See Page 210)

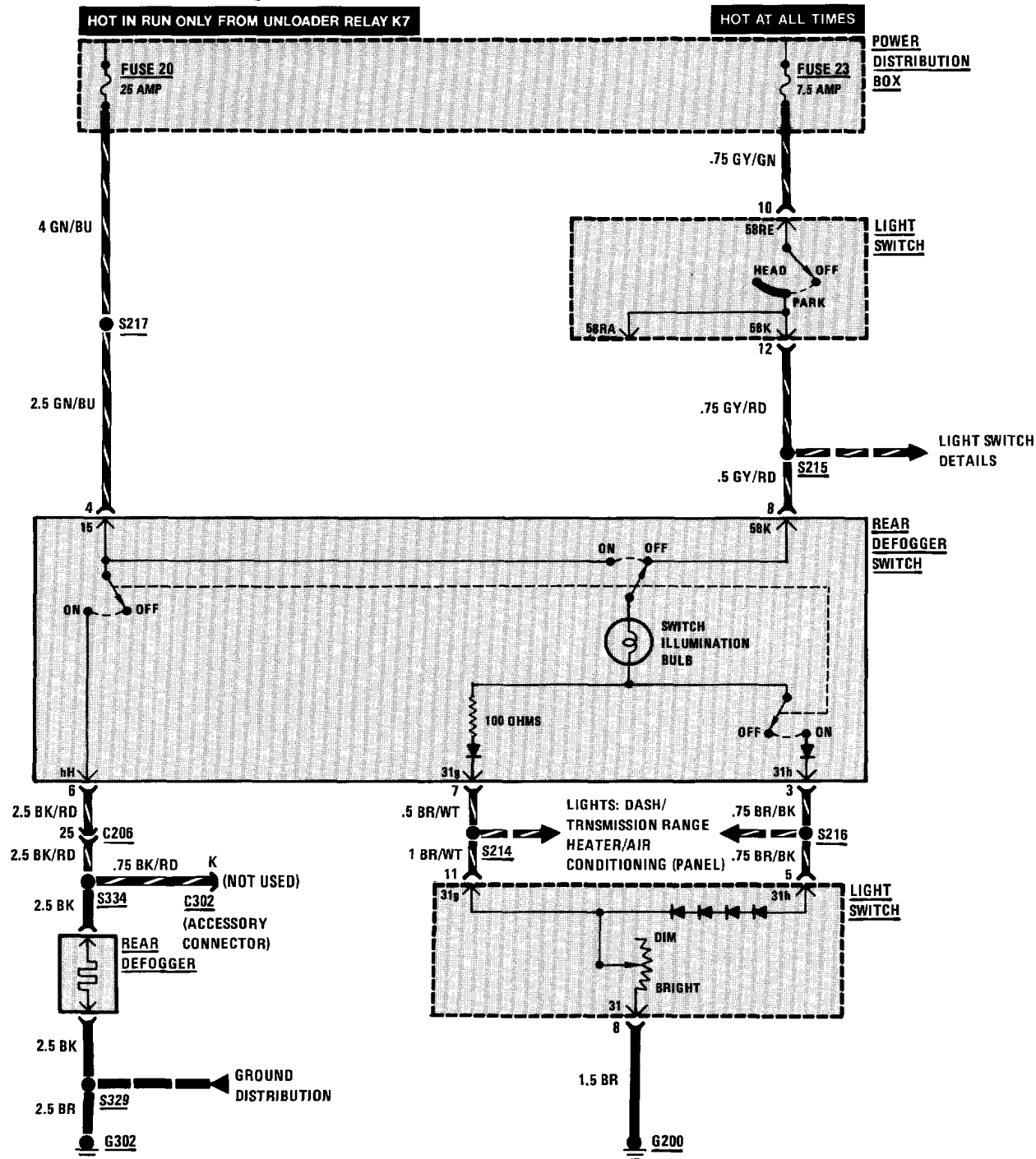

(For Component Locations See Page 209)

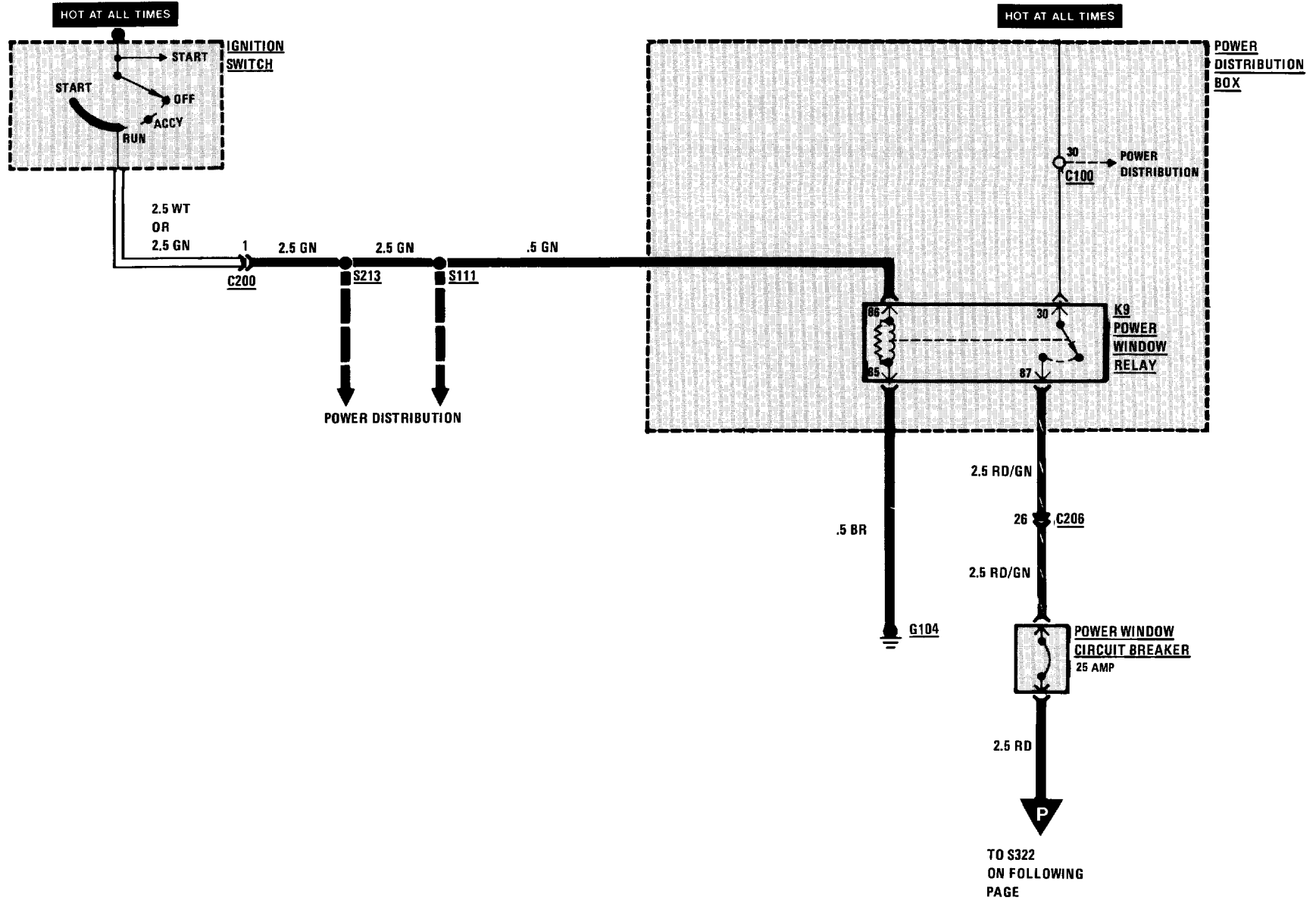

# 150 POWER WINDOWS

(For Component Locations See Page 209)

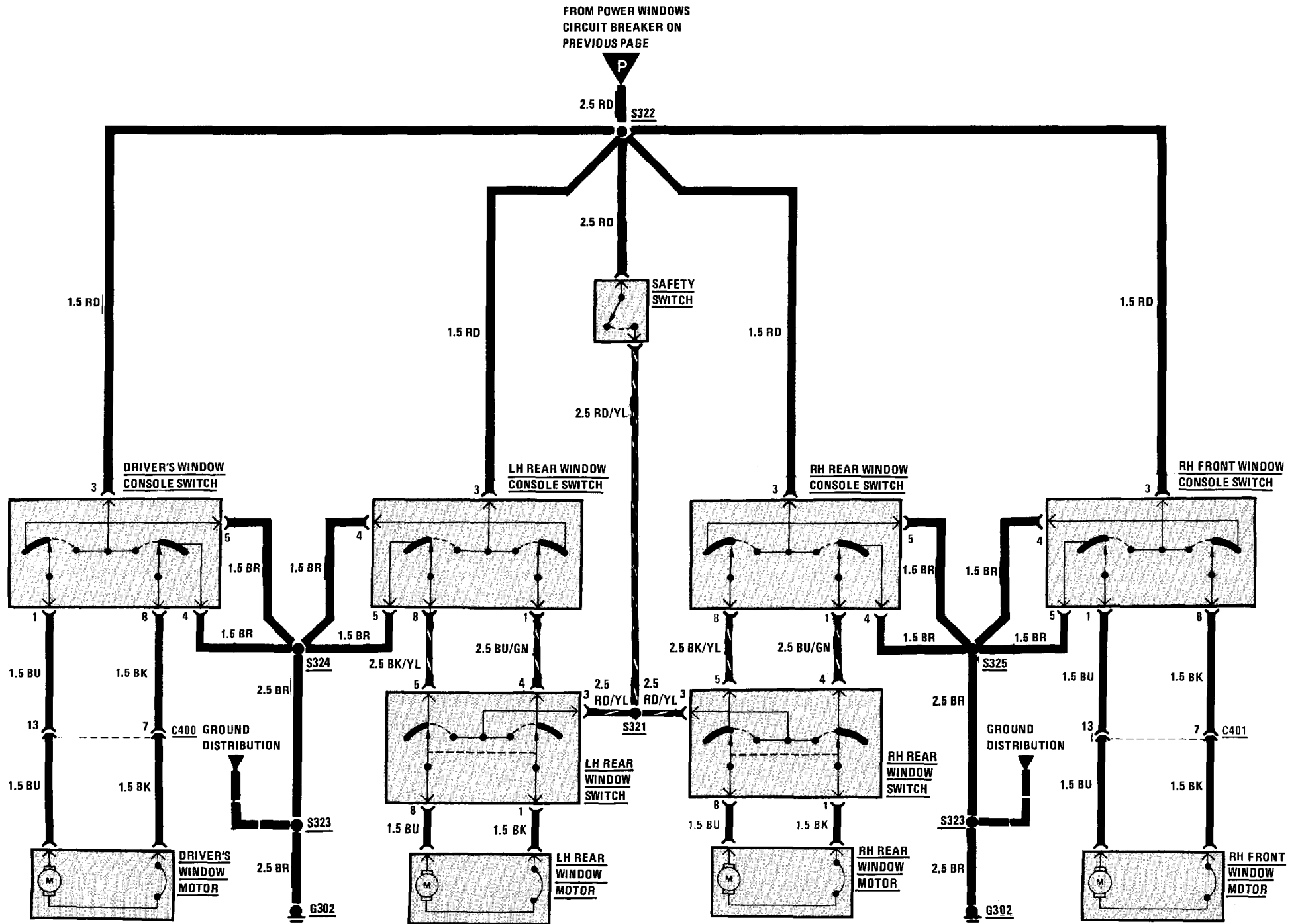

(For Component Locations See Page 202)

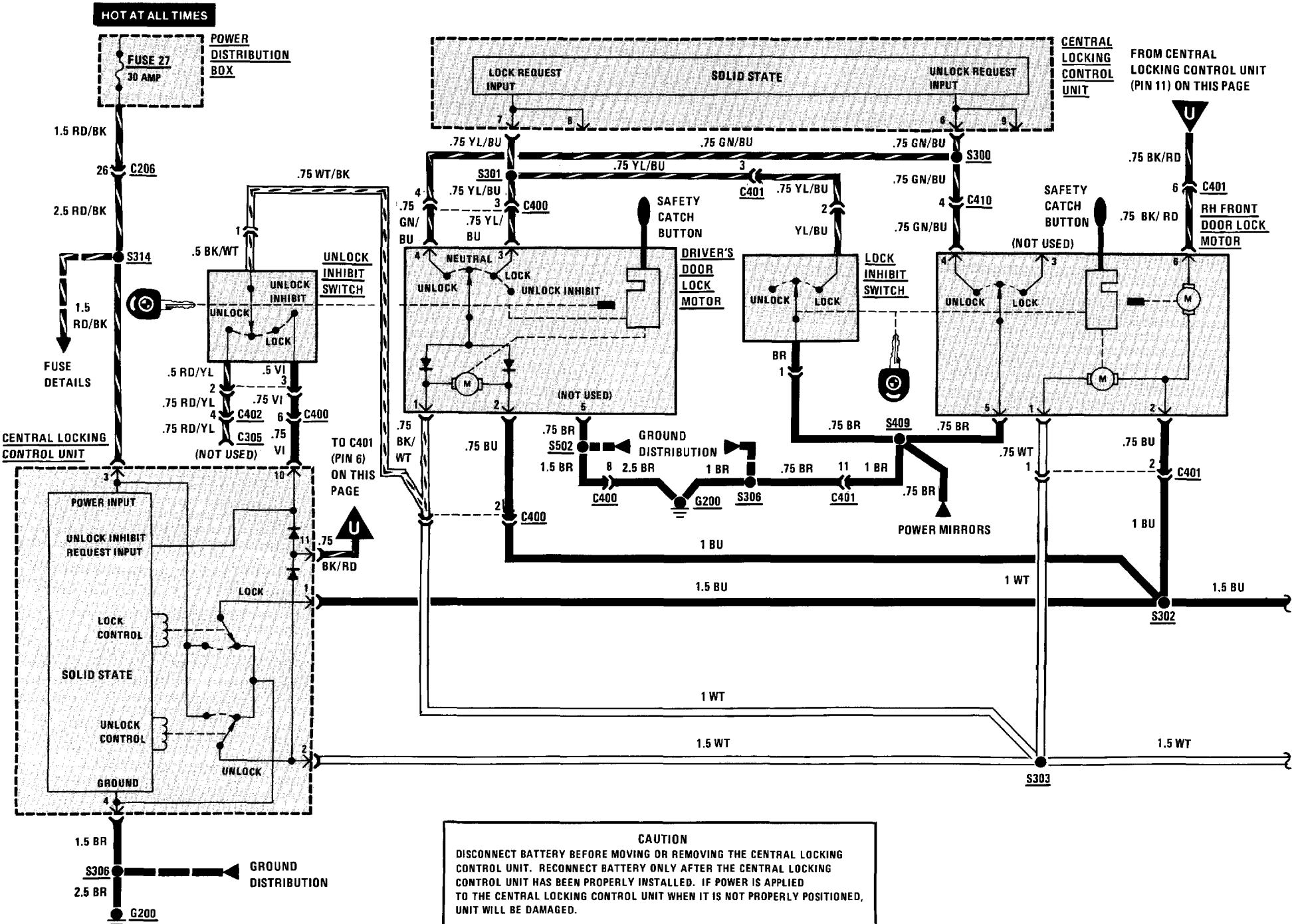

# 152 CENTRAL LOCKING

(For Component Locations See Page 202)

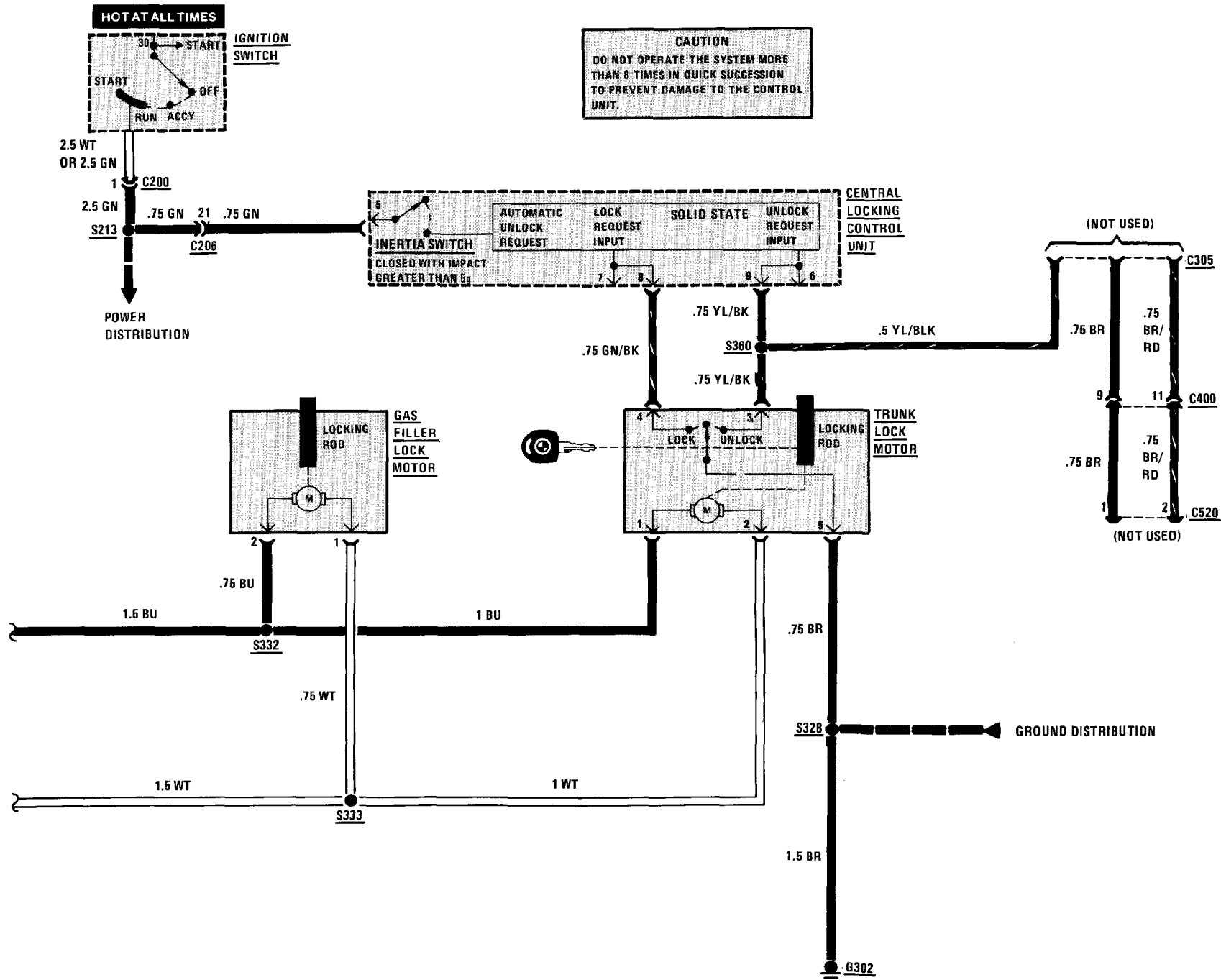

(For Component Locations See Page 209)

HOT IN RUN ONLY FROM UNLOADER RELAY K5

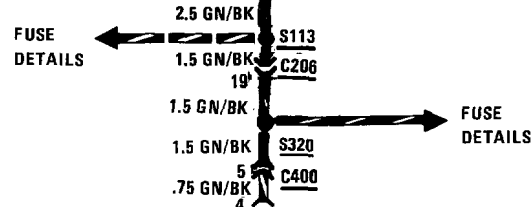
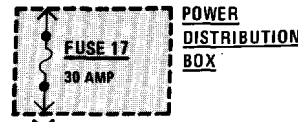

1. MOTOR DIRECTION CONTROLLED BY POLARITY
2. WITH CLUTCH SOLENOID ENERGIZED MOTOR TURNS MIRROR LEFT OR RIGHT
3. ELECTRICALLY HEATED MIRROR TURNS ON BELOW 59 ± 9° F AND TURNS OFF ABOVE 122 ± 18° F

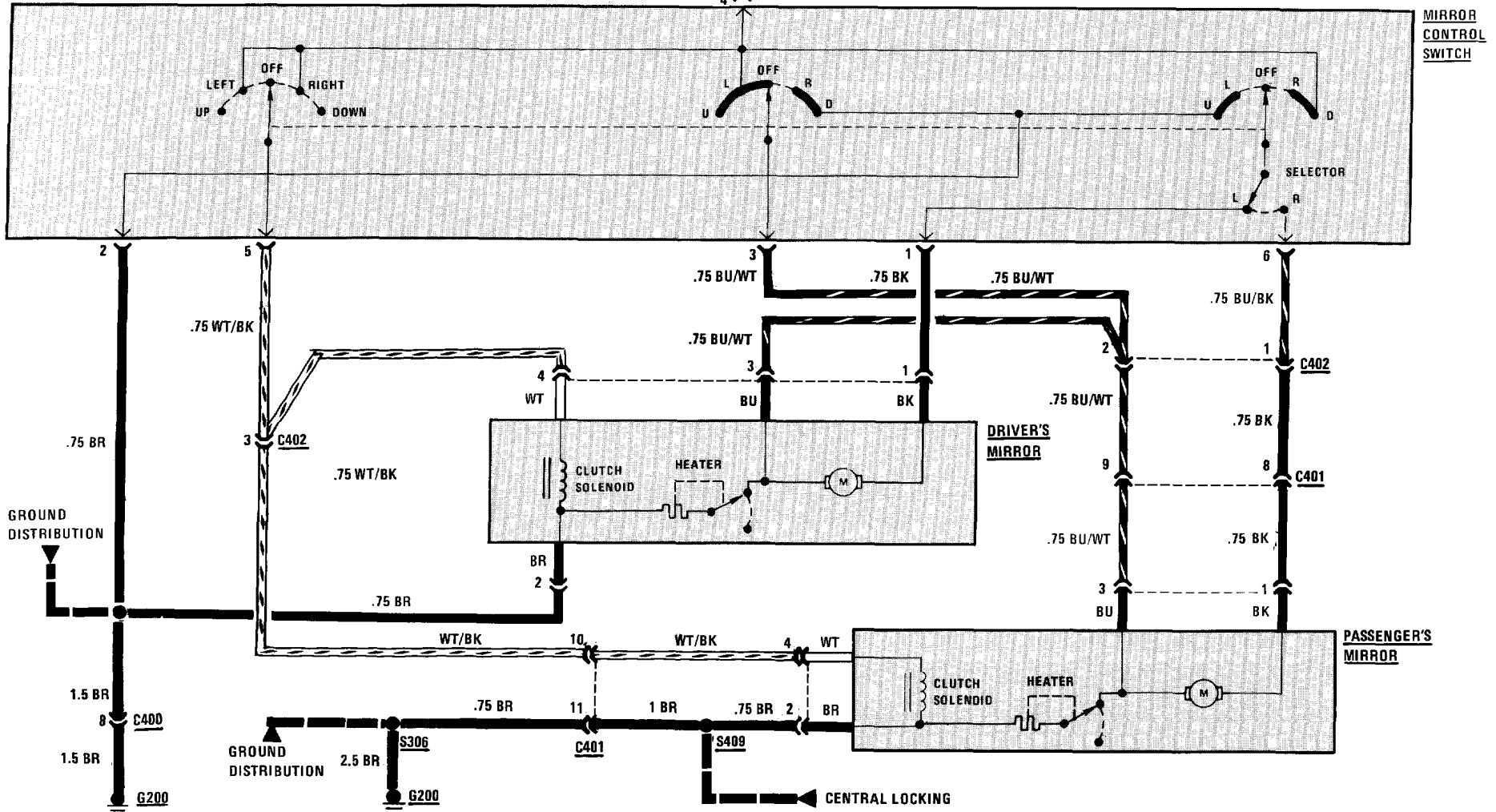



# 154 RADIO/POWER ANTENNA

(For Component Locations See Page 209)

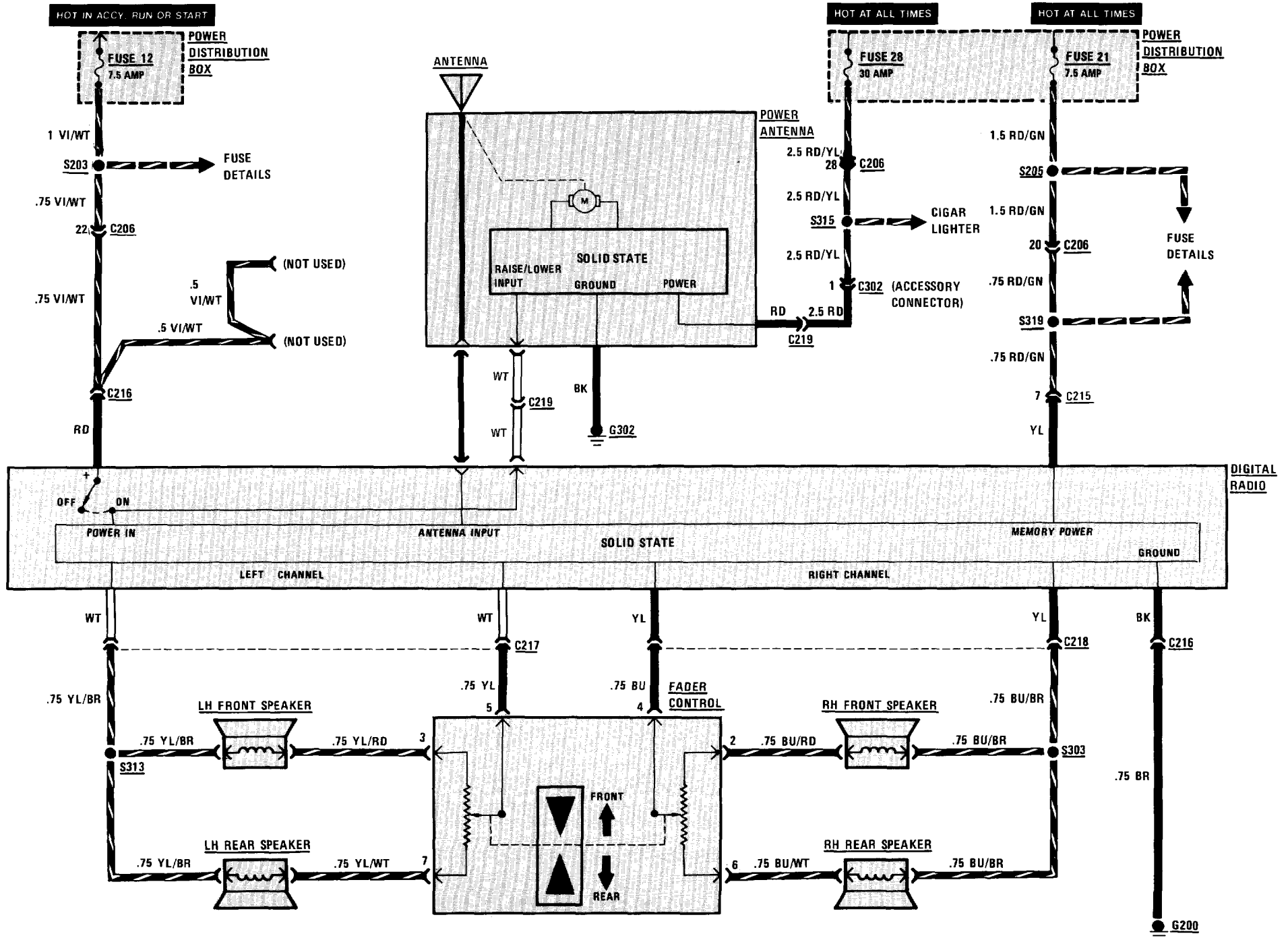

(For Component Locations See Page 201)

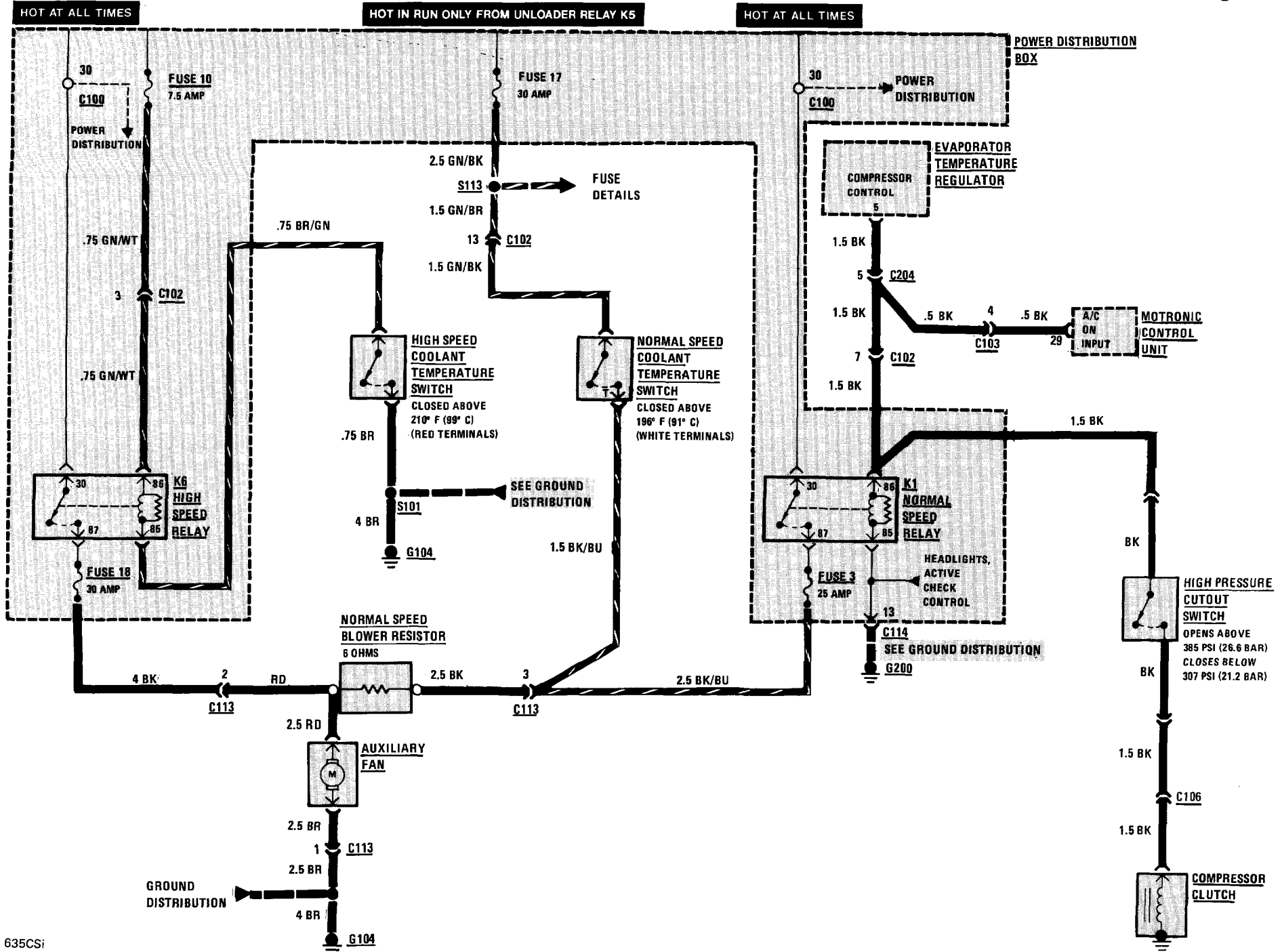

# 156 HEATER/AIR CONDITIONING (PANEL LIGHTS)

(For Component Locations See Page 204)

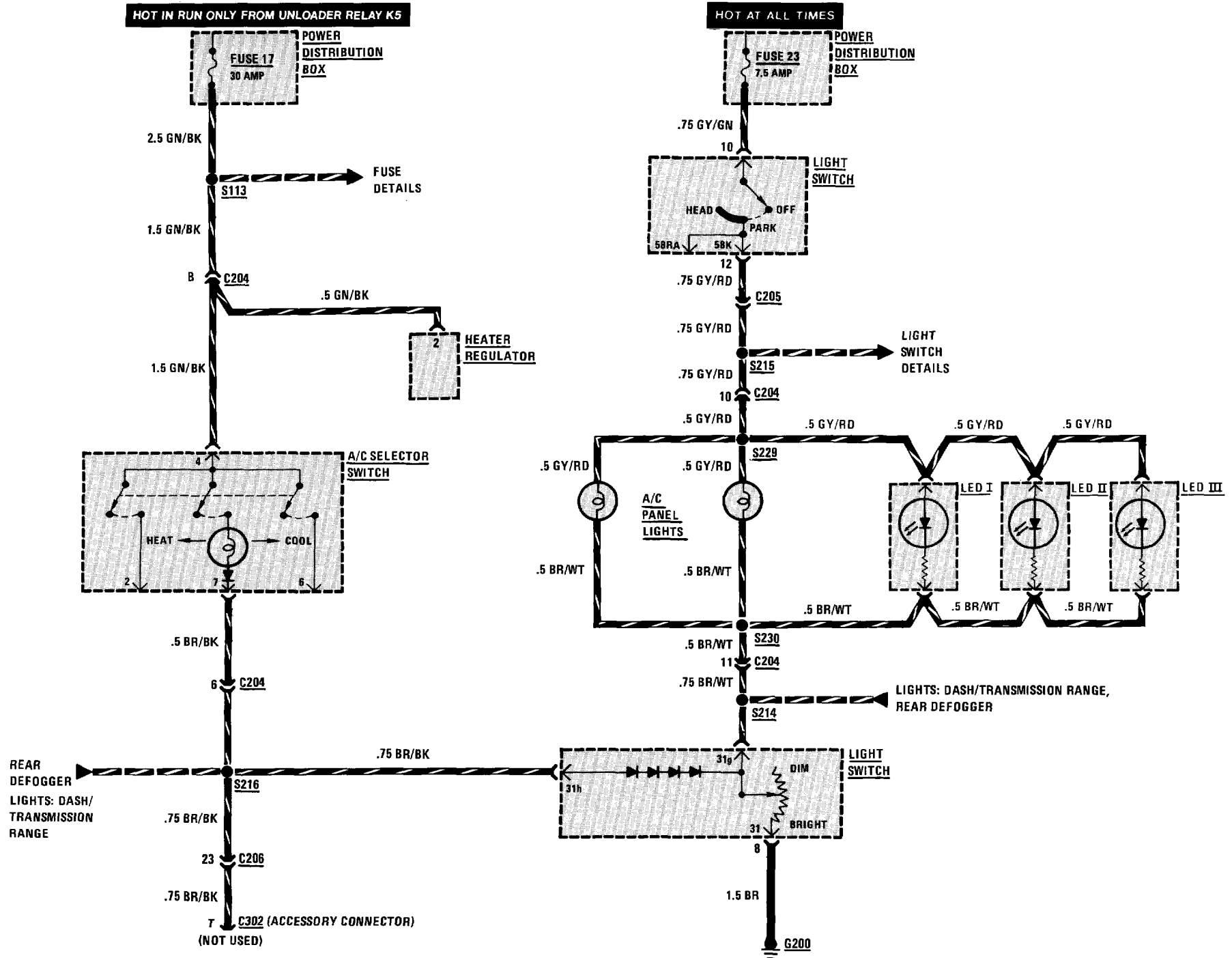



# 158 HEATER/AIR CONDITIONING (BLOWER CONTROL)

(For Component Locations See Page 204)

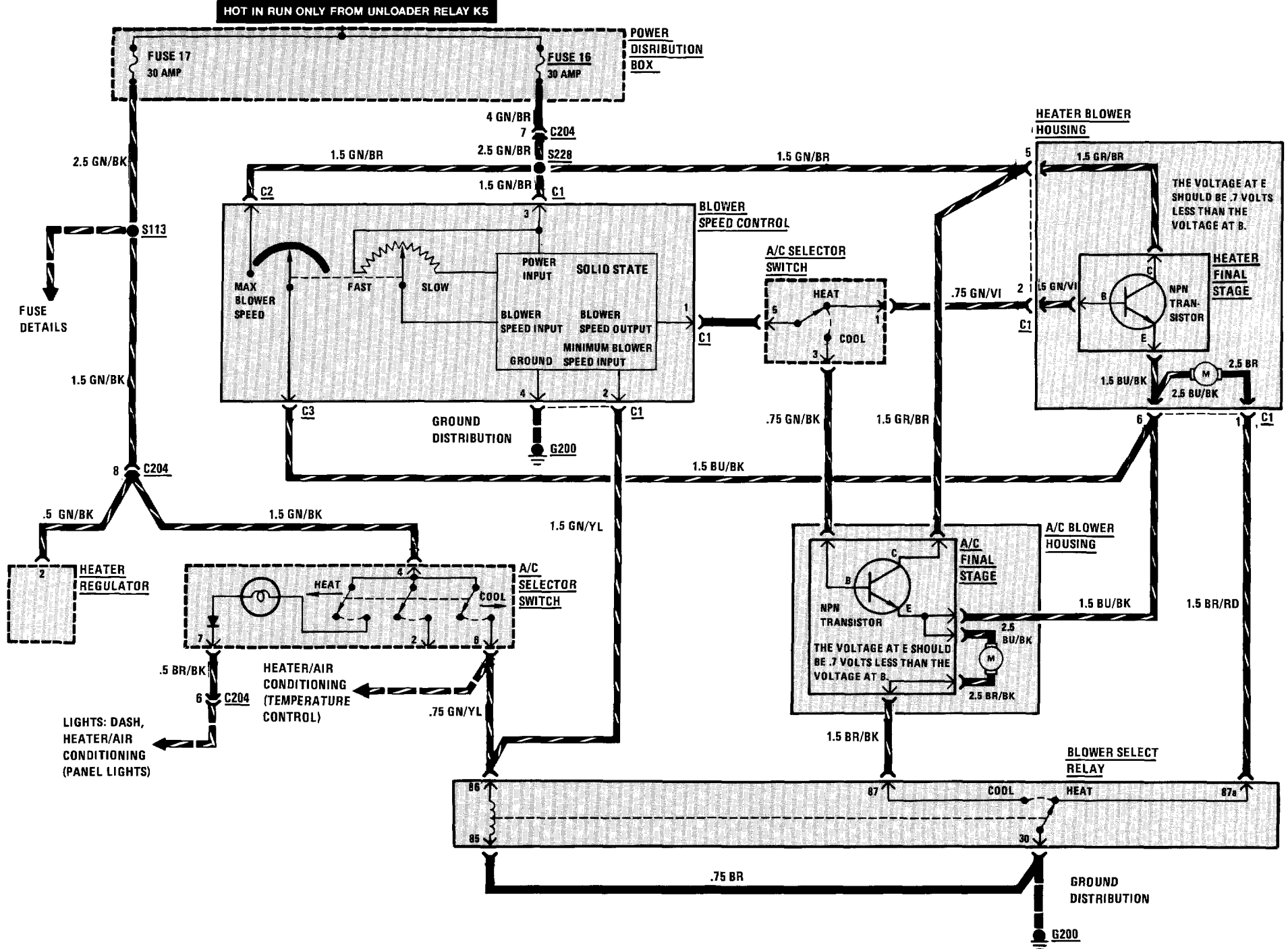

(For Component Locations See Page 212)

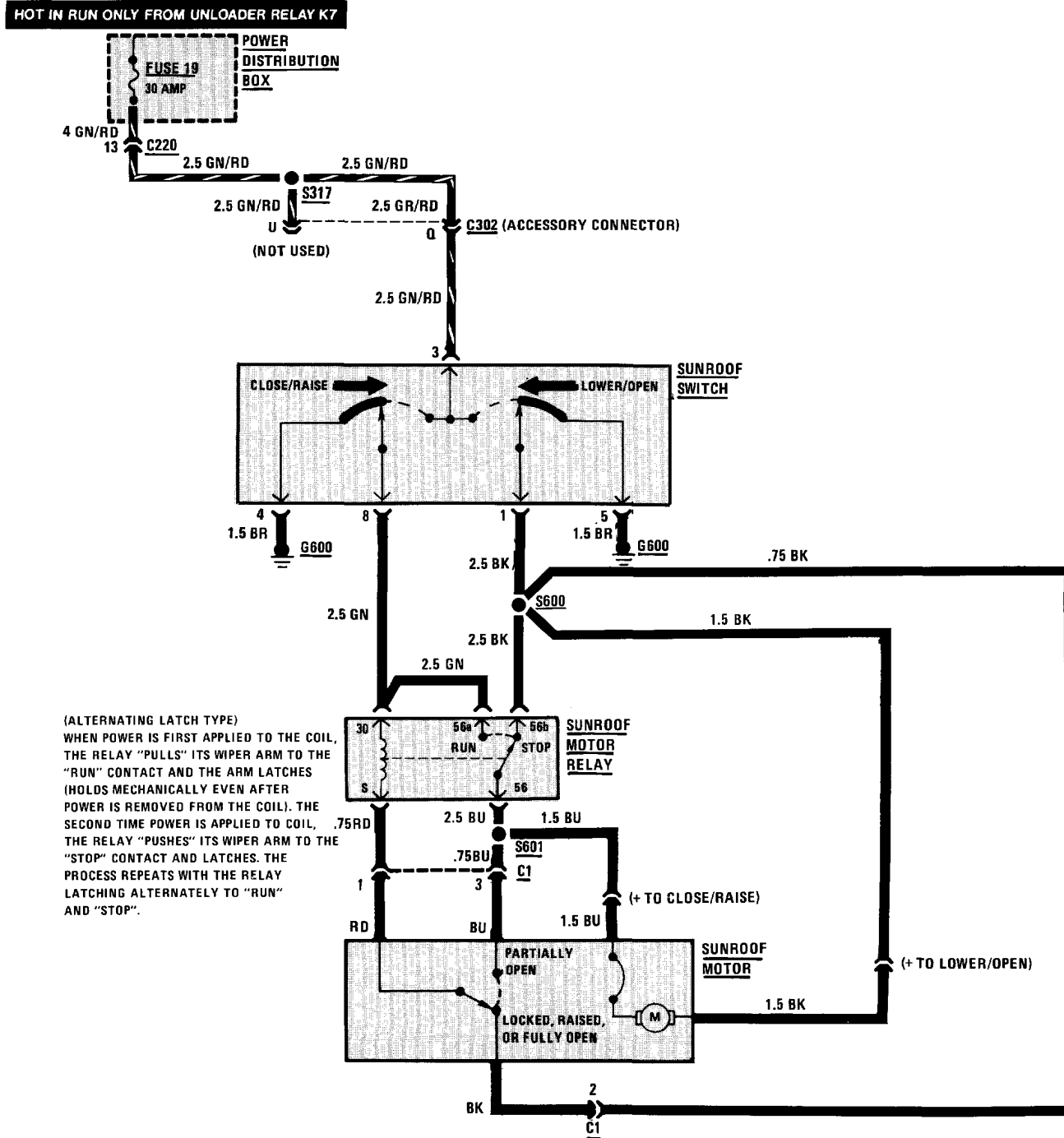

# 160 ANTILOCK BRAKING (ABS)

(For Component Locations See Page 215)

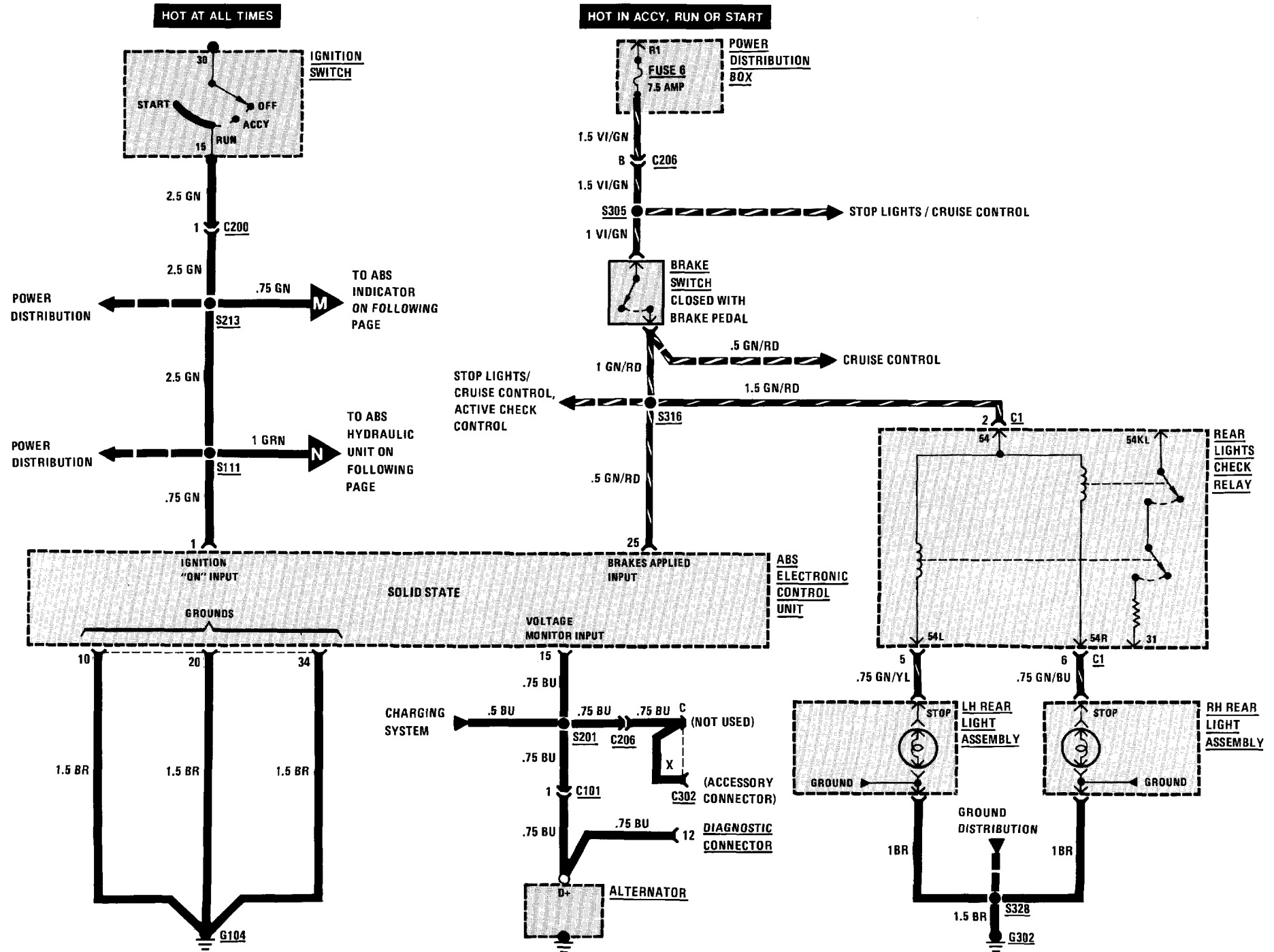

(For Component Locations See Page 215)

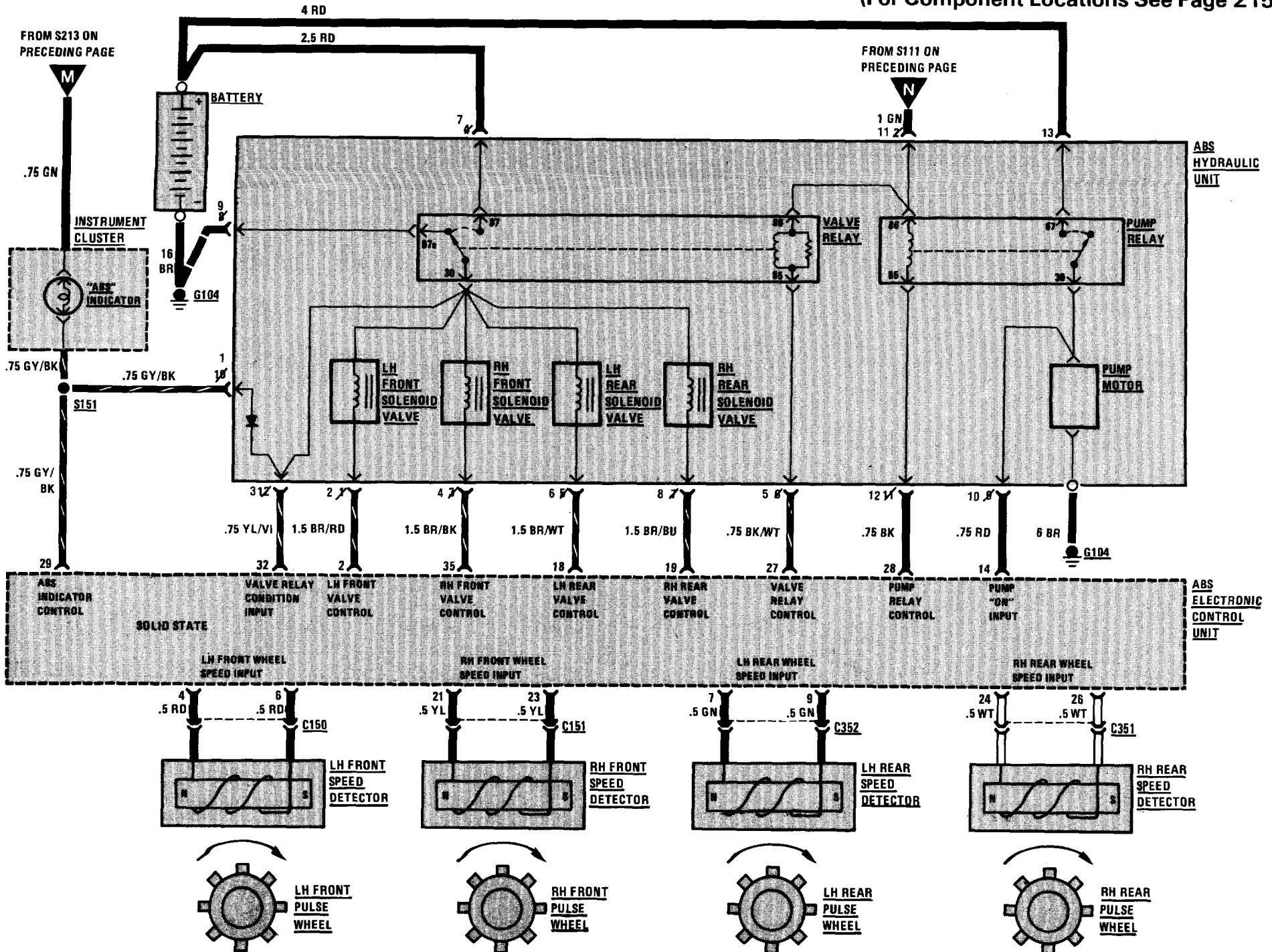



# 162 POWER SEATS

(For Component Locations See Page 215)

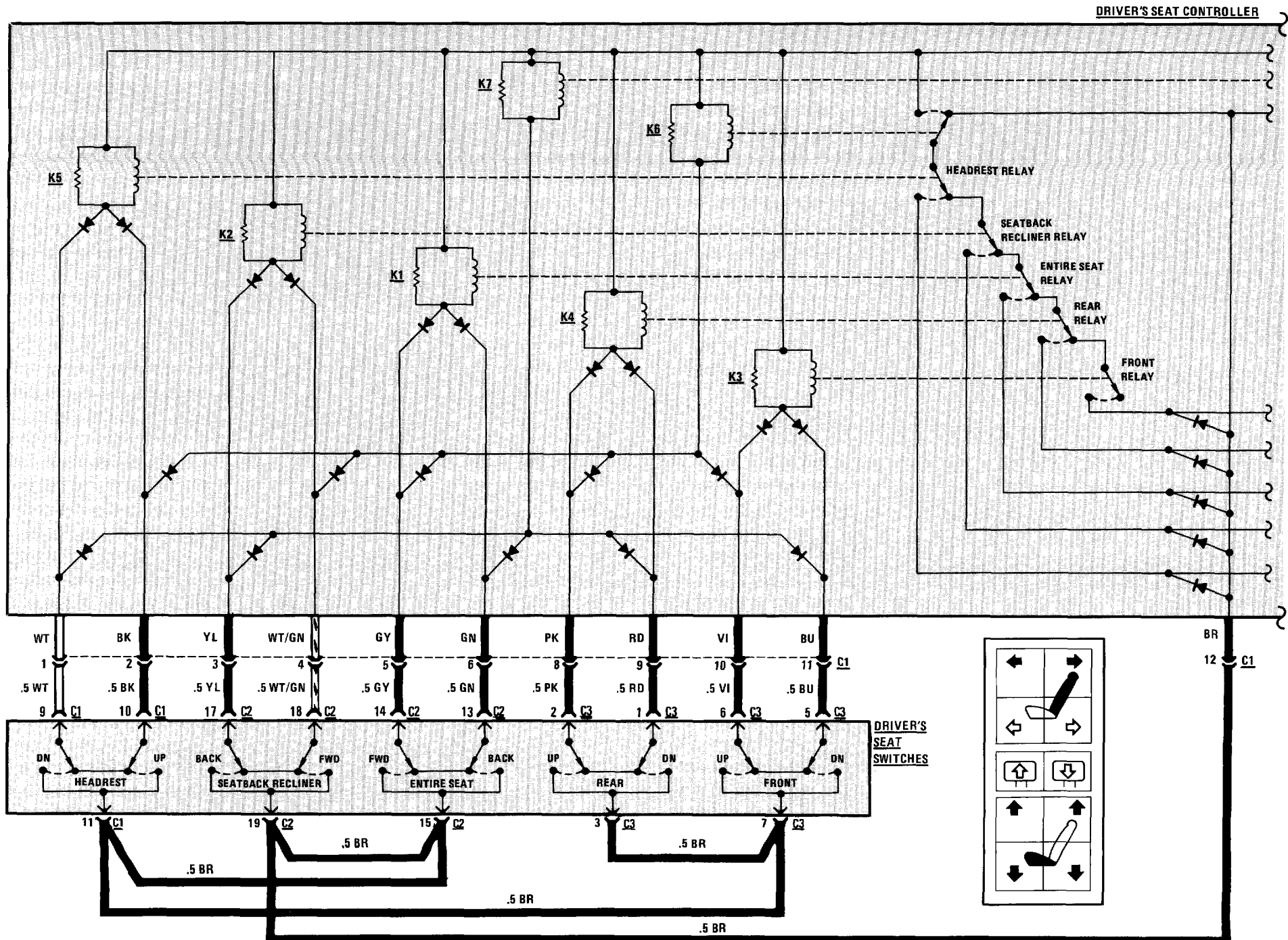

(For Component Locations See Page 215)

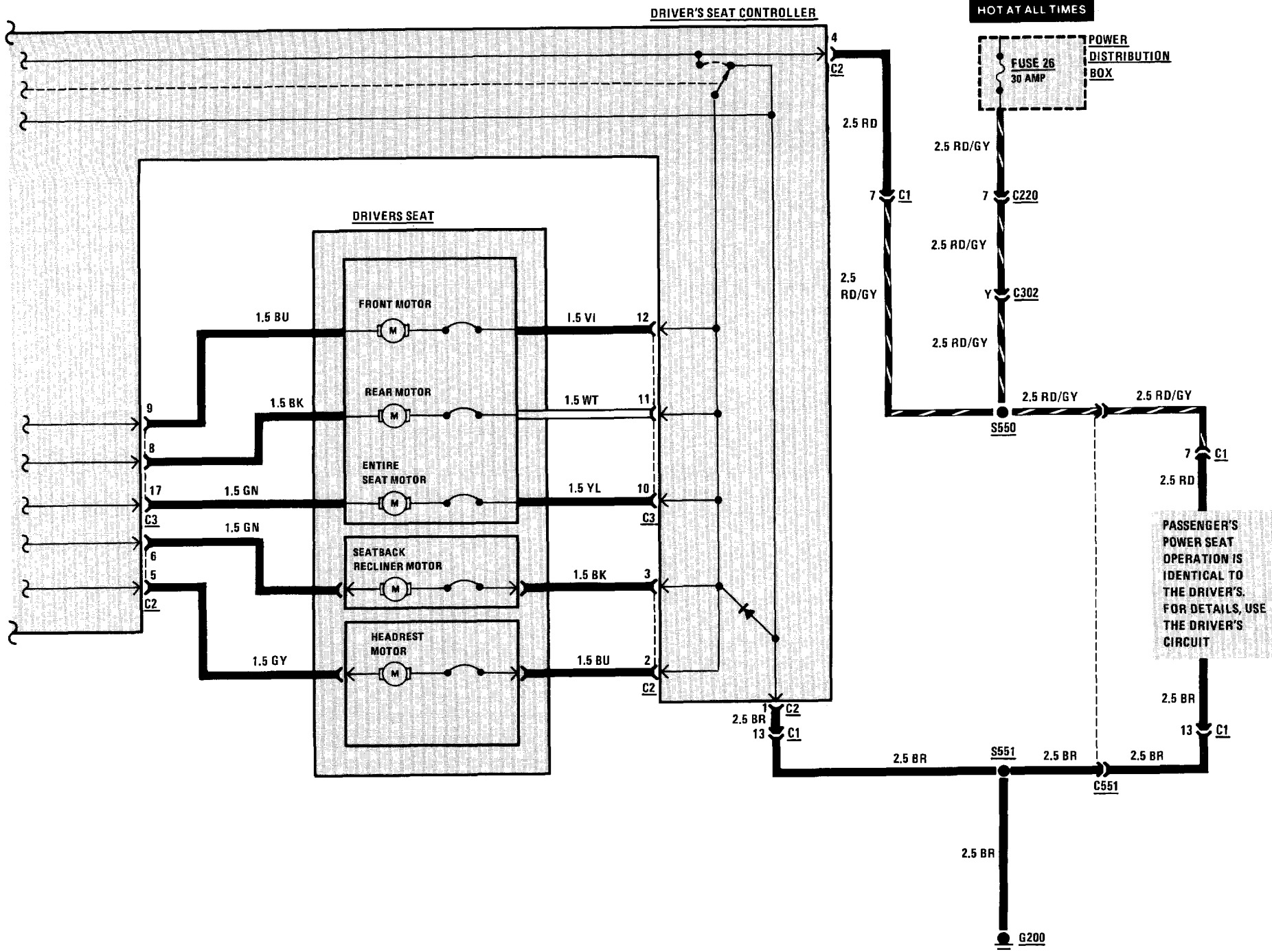

# 164 WINDSHIELD WASHER JET HEATERS

(For Component Locations See Page 212)

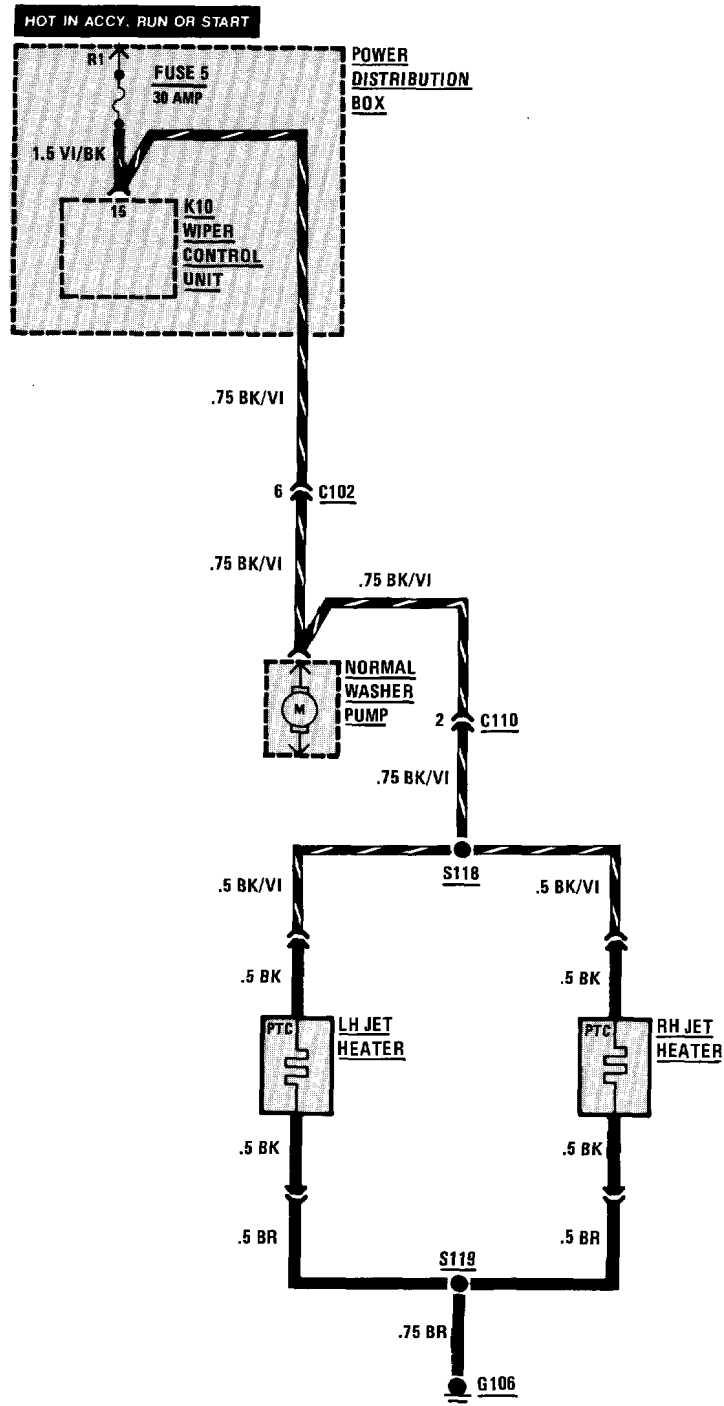

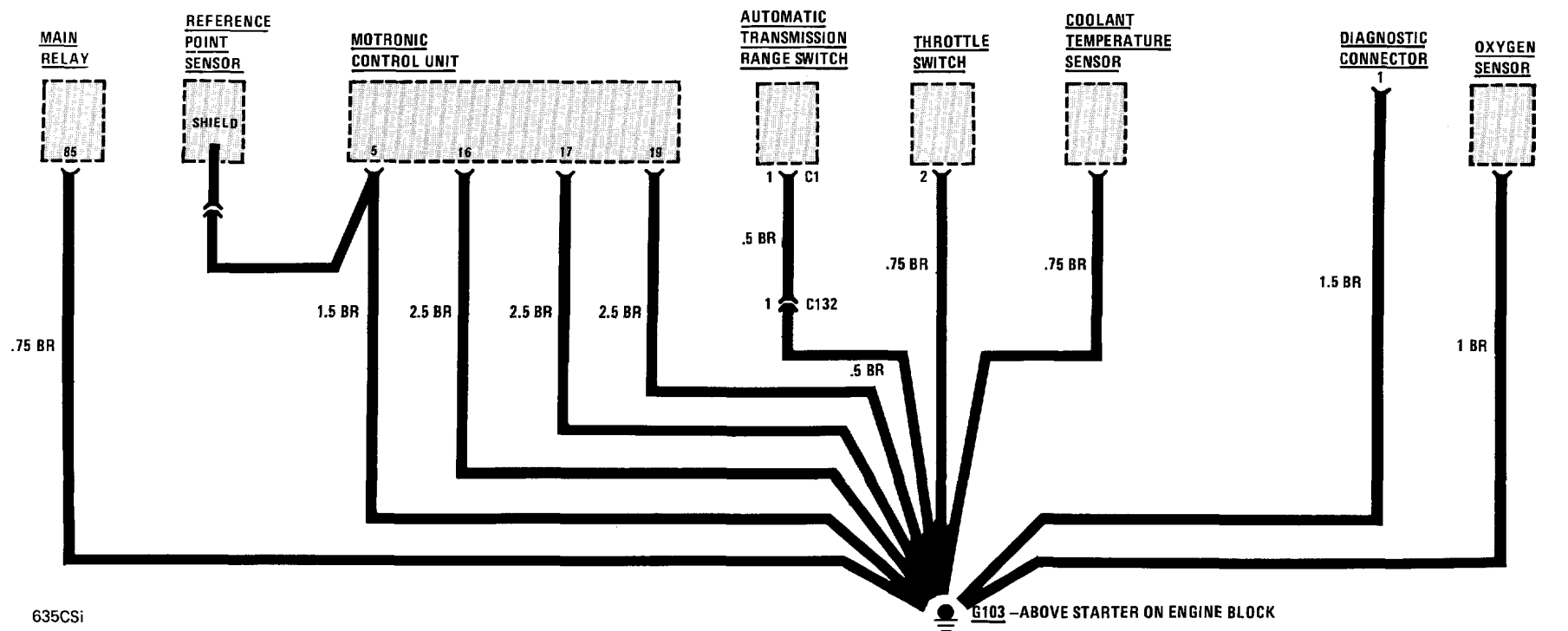
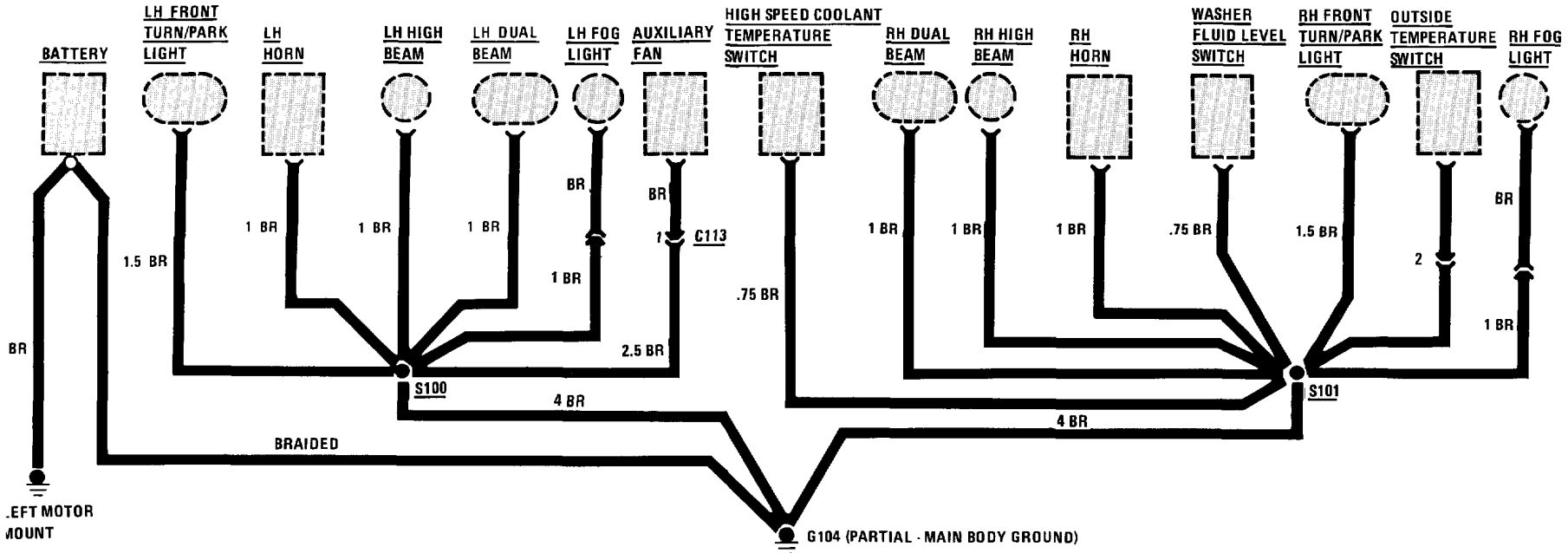

# 166 GROUND DISTRIBUTION (G200)

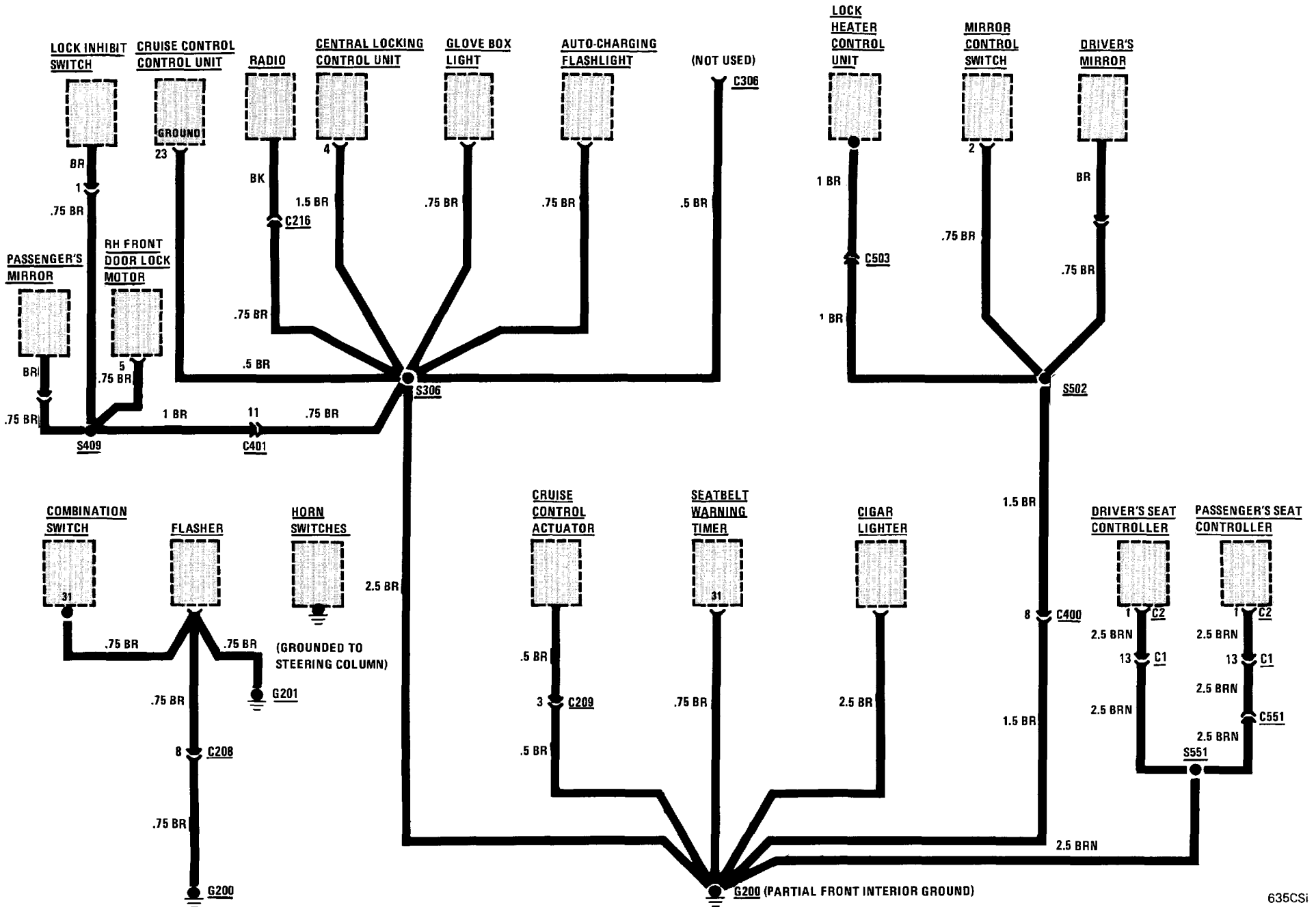

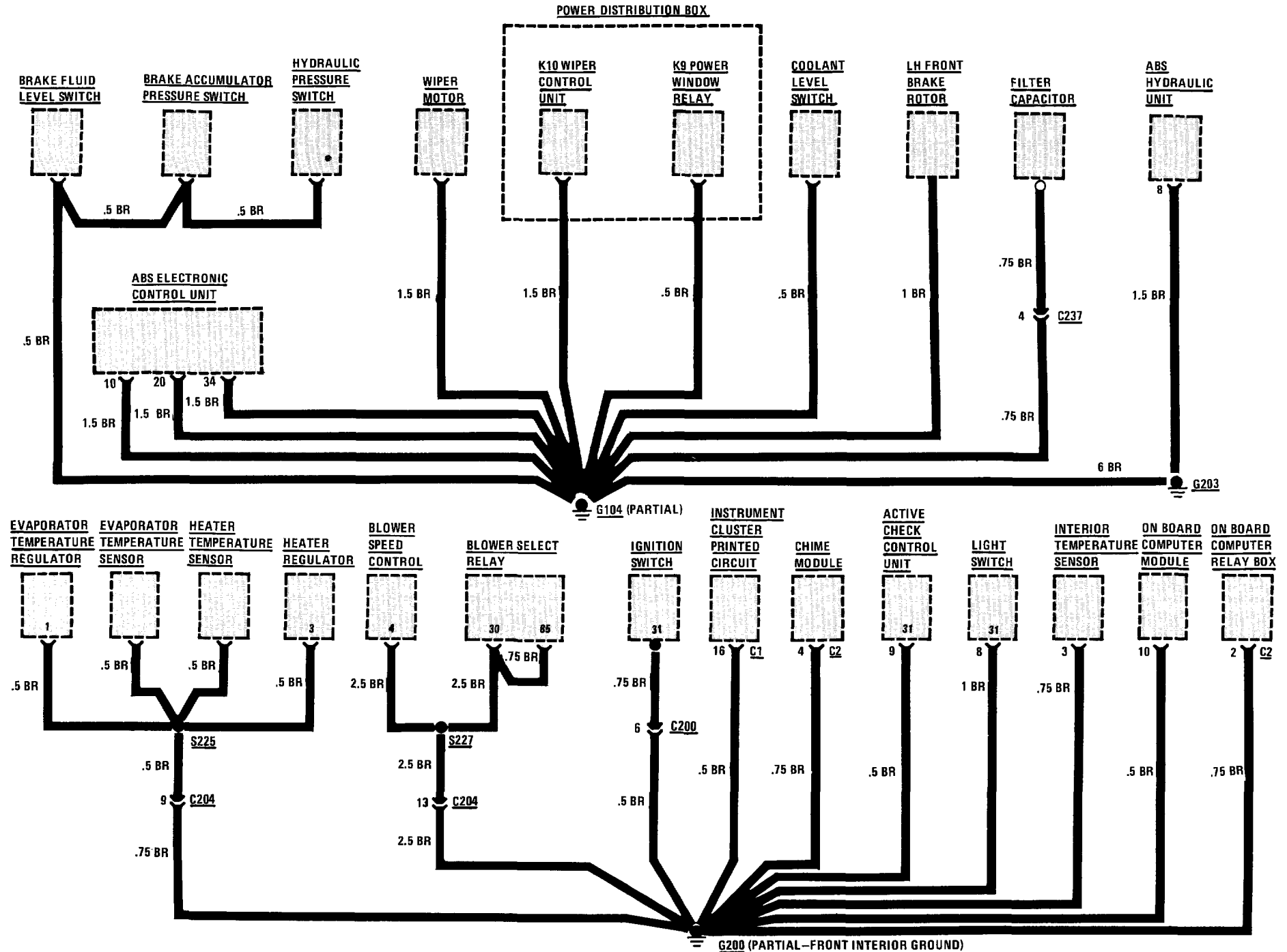

# 168 GROUND DISTRIBUTION (G302)

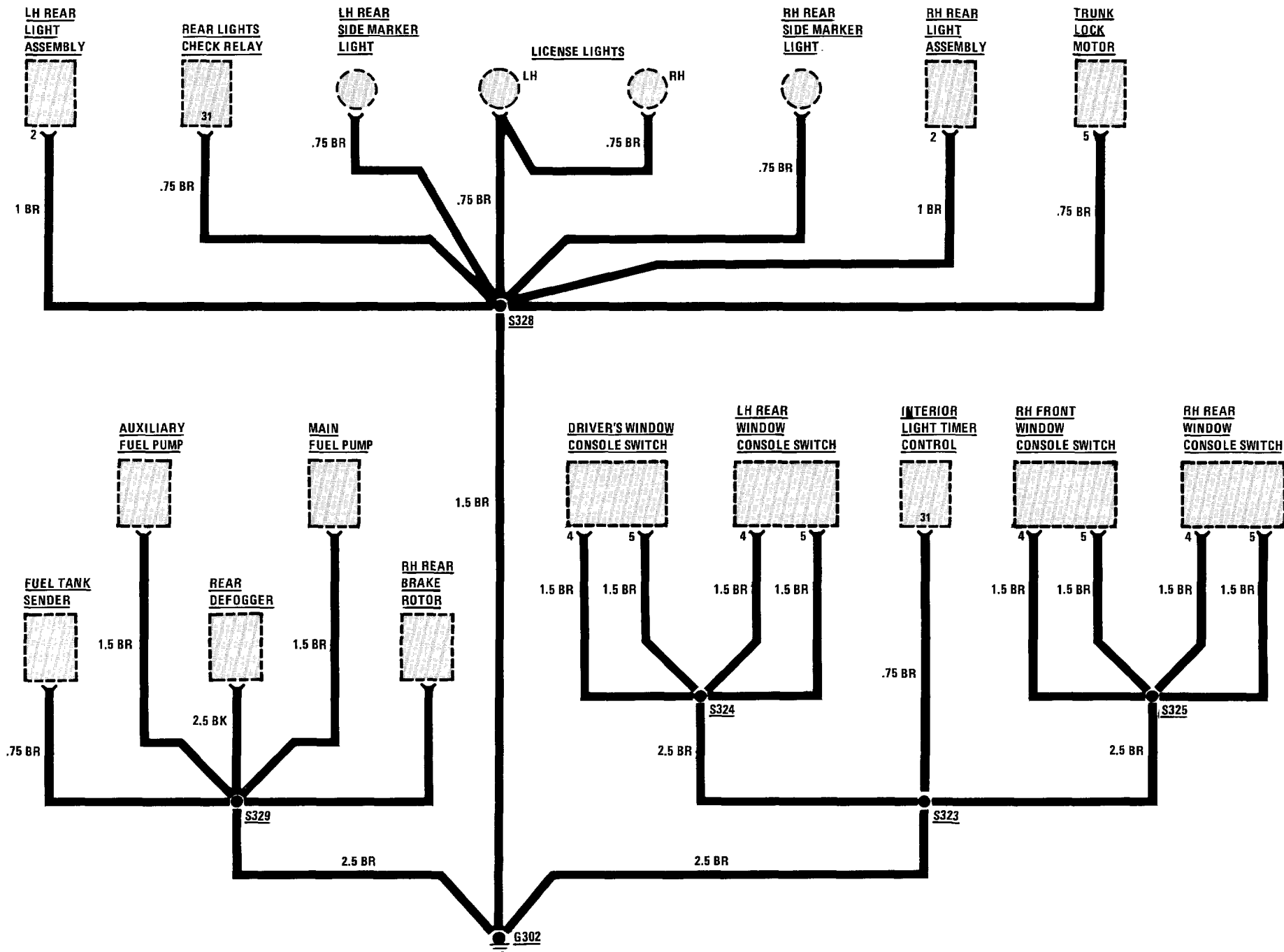

This index contains all the splices in the car, what harness each one is in, and the page that the splices appear on. The drawings after the index show how the harness is routed through the car and where the splices are located on the harness.

SPLICE	HARNESS	PAGE NUMBER	SPLICE	HARNESS	PAGE NUMBER	SPLICE	HARNESS	PAGE NUMBER
S100	FRONT	170	S213	MIDDLE	171	S316	REAR	NOT SHOWN
S101	FRONT	170	S214	MIDDLE	171	S317	REAR	173
S102	FRONT	170	S215	MIDDLE	171	S319	REAR	173
S103	FRONT	170	S216	MIDDLE	171	S320	REAR	173
S105	ENGINE	172	S217	MIDDLE	171	S324	REAR	173
S106	ENGINE	172	S221	REAR	173	S325	REAR	173
S108	ENGINE	172	S222	REAR	173	S326	REAR	173
S109	ENGINE	172	S223	REAR	173	S327	REAR	NOT SHOWN
S110	ENGINE	172	S225	A/C	NOT SHOWN	S328	REAR	173
S111	MIDDLE	171	S226	A/C	NOT SHOWN	S329	REAR	173
S112	MIDDLE	171	S227	A/C	NOT SHOWN	S330	REAR	NOT SHOWN
S113	MIDDLE	171	S228	A/C	NOT SHOWN	S331	REAR	173
S115	MIDDLE	171	S229	A/C	NOT SHOWN	S332	REAR	173
S116	MIDDLE	171	S230	A/C	NOT SHOWN	S333	REAR	173
S117	FRONT	170	S300	REAR	173	S334	REAR	173
S118	WASHER JETS	NOT SHOWN	S301	REAR	173	S360	REAR	173
S119	WASHER JETS	NOT SHOWN	S302	REAR	173	S361	REAR	173
S151	MIDDLE	NOT SHOWN	S303	REAR	173	S409	DOOR	NOT SHOWN
S200	MIDDLE	171	S304	REAR	173	S502	DOOR	NOT SHOWN
S201	MIDDLE	171	S305	REAR	173	S550	POWER SEATS	NOT SHOWN
S203	MIDDLE	171	S306	REAR	173	S551	POWER SEATS	NOT SHOWN
S205	MIDDLE	171	S307	REAR	173	S600	SUNROOF	NOT SHOWN
S206	MIDDLE	171	S308	REAR	173	S601	SUNROOF	NOT SHOWN
S207	MIDDLE	171	S309	REAR	173			
S208	MIDDLE	171	S310	REAR	173			
S209	MIDDLE	171	S313	REAR	173			
S210	MIDDLE	171	S314	REAR	173			
S211	MIDDLE	171	S315	REAR	173			
S212	MIDDLE	171						



# 170 SPLICE LOCATIONS FOR FRONT HARNESS

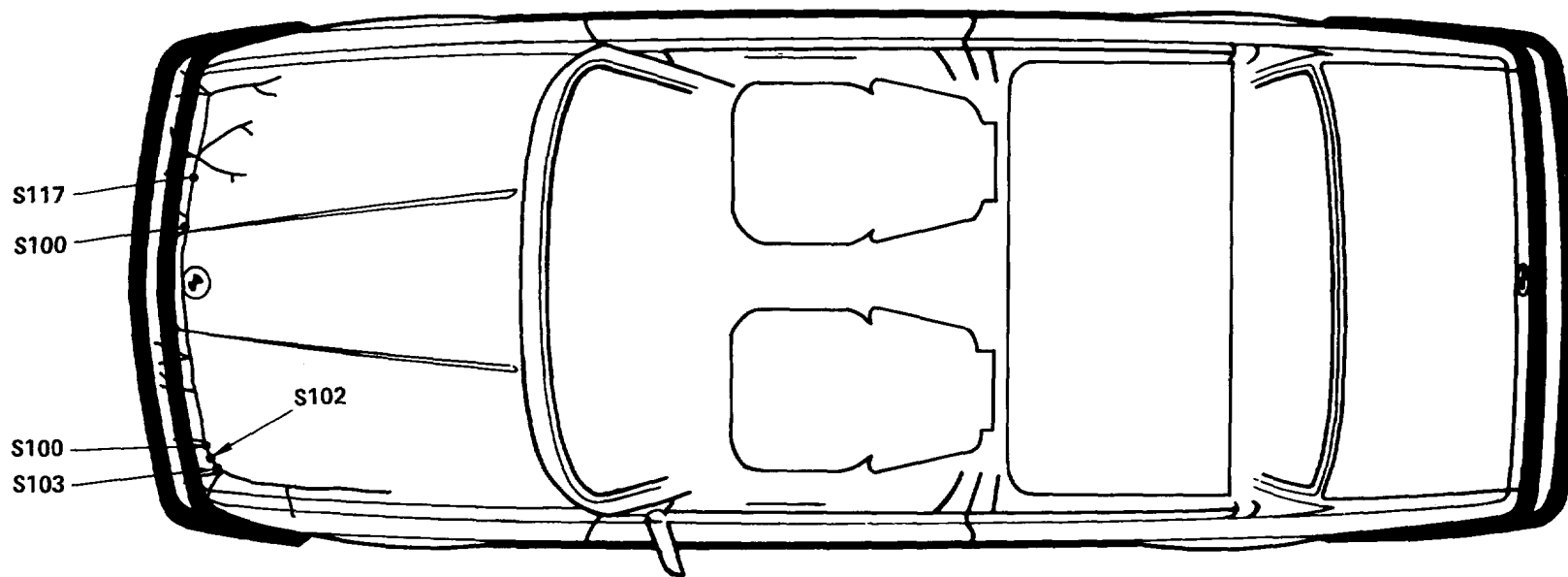

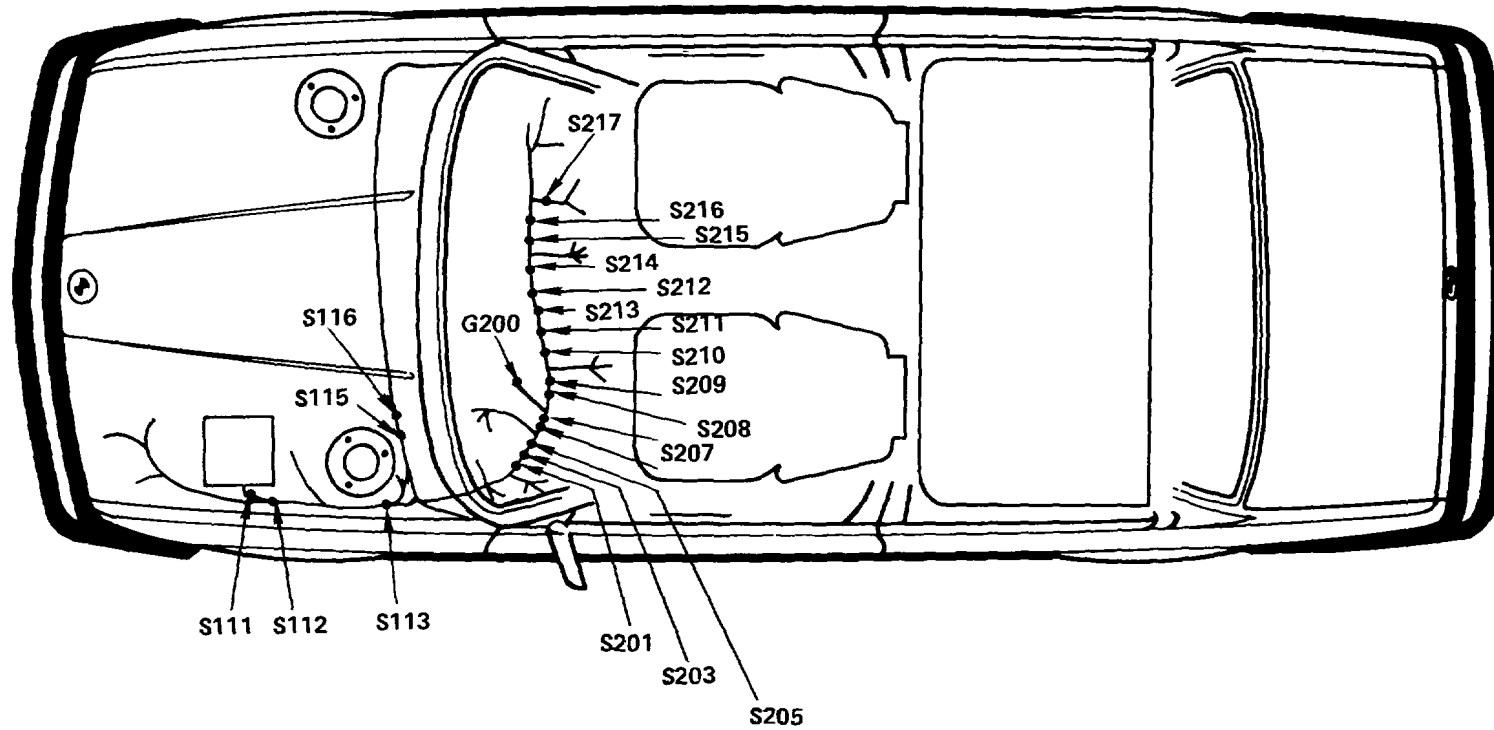

172 SPLICE LOCATIONS FOR ENGINE HARNESS

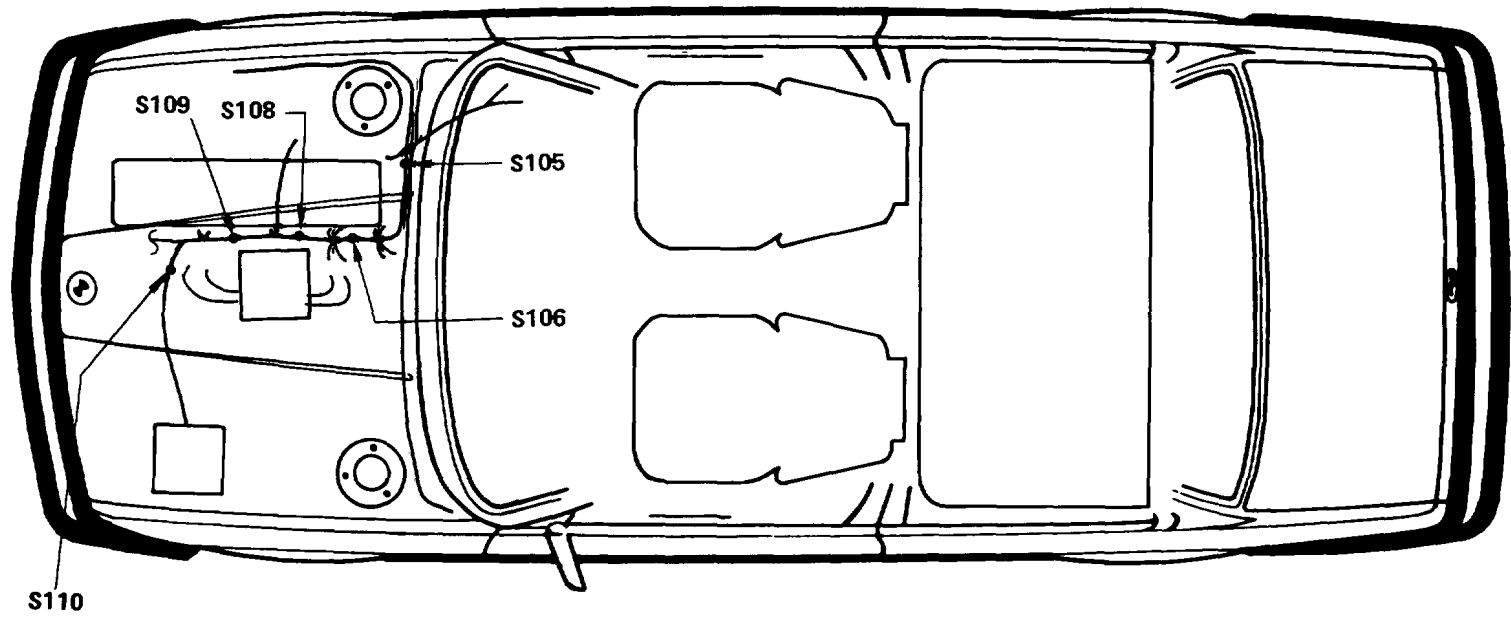

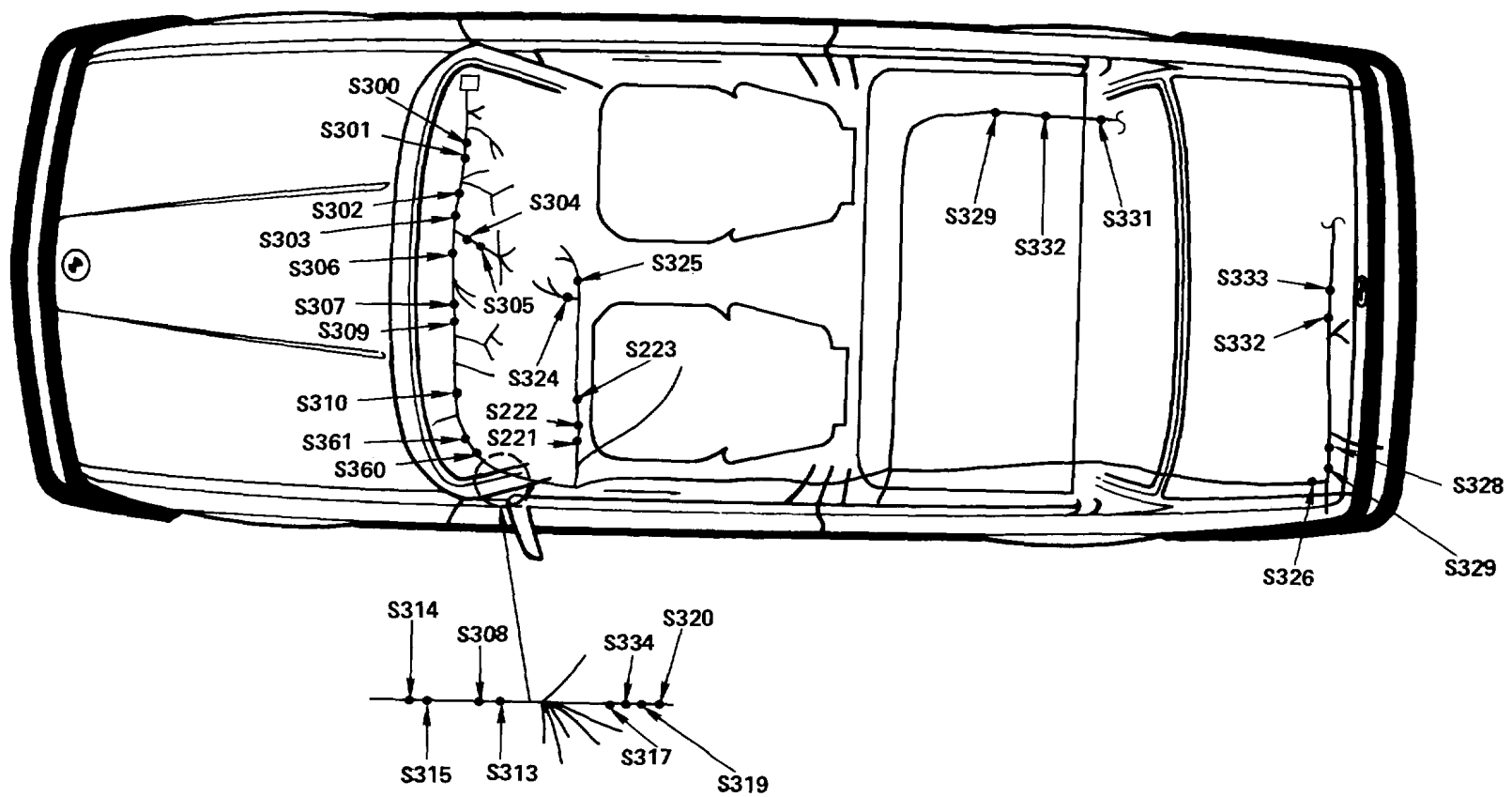



**ACTIVE CHECK CONTROL**

Brake Switch .....	Above brake pedal .....	213-5
Coolant Level Switch .....	Top of coolant reservoir .....	202-1
Oil Level Sensor .....	Bottom of engine oil pan	
Power Distribution Box .....	Top front of left front wheel well .....	204-1
Rear Lights Check Relay .....	In trunk, left of rear panel center support .....	210-2
Seatbelt Warning Timer .....	Under LH dash, on body electrical bracket.....	214-3
Washer Fluid Level Switch ....	Ahead of right front wheel well, in reservoir .....	207-2
C101 (17 pin).....	On right side of power distribution box .....	201-2
C102 (12 pin).....	In power distribution box	
C205 (1 pin) .....	Under left side of dash	
C206 (29 pin).....	Under LH dash, on body electrical bracket.....	157-1
G104 (Main Body Ground) ....	Left fender, behind headlights .....	201-1
G200 (Front Interior Ground) ..	On dash frame, left of steering column.....	203-2
G302 (Rear Interior Ground) ..	Under left rear seat .....	212-2

**FIGURE**

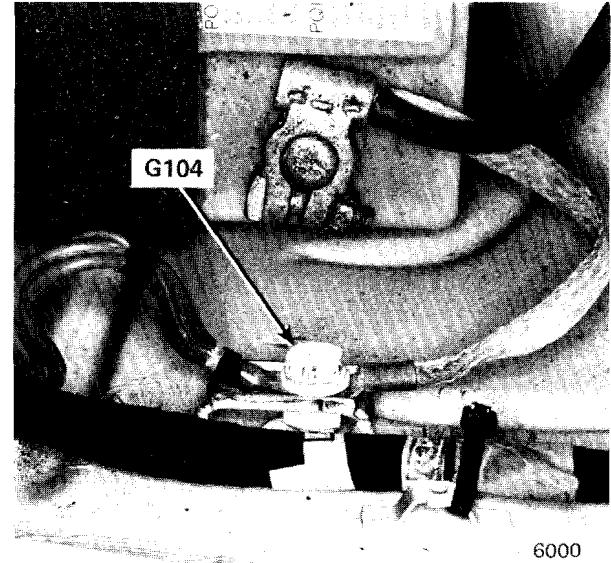

Figure 1 - Inner Fender, Left Of Battery

**AUXILIARY FAN**

C103 (4 pin).....	Under right side of dash above glove box .....	211-2
Evaporator Temp. Regulator ...	On left side of heater-A/C unit.....	213-6
High Pressure Cut-out Switch .	On receiver-dryer.....	207-2
High Speed Coolant Temp. Switch .....	Upper right side of radiator (red terminal) .....	208-1
Motronic Control Unit.....	Under right side of dash above glove box	
Normal Speed Blower Resistor.	Ahead of radiator, on auxiliary fan shield	
Normal Speed Cool. Temp. Switch .....	Upper right side of radiator (white terminal).....	208-1
Power Distribution Box .....	Top front of left front wheel well .....	204-1
C102 (12 pin).....	In power distribution box	
C103 (4 pin).....	Under right side of dash above glove box	
C106 (1 pin) .....	Behind right headlights	
C113 (3 pin) .....	Left side of auxiliary fan shield	
C204 (13 pin).....	Behind center console	
G104 (Main Body Ground) ....	Left fender, behind headlights .....	201-1
G200 (Front Interior Ground) ..	On dash frame, left of steering column.....	203-2
Motronic Control Unit.....	Under right side of dash above glove box .....	211-2

**BACKUP LIGHTS**

Auto. Trans. Range Switch ....	On left side of shift lever	
Backup Light Switch.....	On left side of manual transmission	
Power Distribution Box .....	Top front of left front wheel well .....	204-1
C220 (13 pin).....	Under LH dash on body electrical bracket	
C301 (2 pin) .....	In center console, ahead of shift lever	
G302 (Rear Interior Ground) ..	Under left rear seat .....	212-2

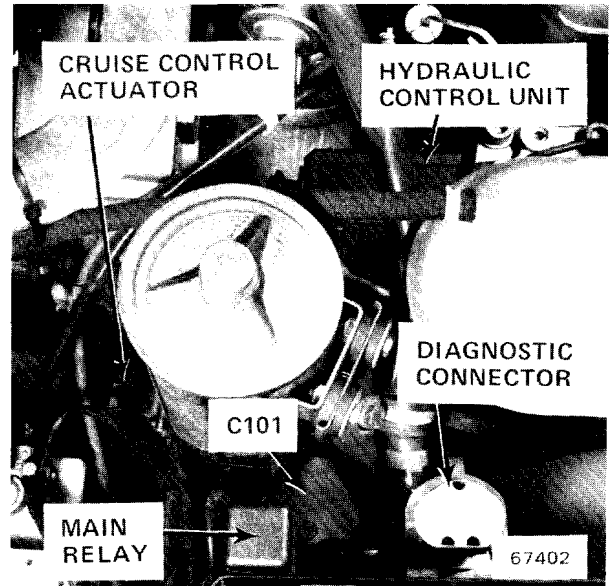

Figure 2 - Right Of Left Front Wheel Well

## 202 COMPONENT LOCATIONS

### BRAKE LINING WARNING

		FIGURE
Power Distribution Box .....	Top front of left front wheel well .....	204-1
C206 (29 pin) .....	Under LH dash, on body electrical bracket .....	157-1
G200 (Front Interior Ground) .....	On dash frame, left of steering column .....	203-2
G302 (Rear Interior Ground) .....	Under left rear seat .....	212-2

### CENTRAL LOCKING

Central Locking Control Unit ...	Under dash, left of top of glove box .....	213-1
Door Lock Motors .....	In each door	
Gas Filler Lock Motor .....	In trunk, behind right rear wheel well .....	211-1
Ignition Switch .....	In upper part of steering column	
Lock Inhibit Switch .....	In passenger's door at lock cylinder	
Power Distribution Box .....	Top front of left front wheel well .....	204-1
Trunk Lock Motor .....	In trunk, in trunk lock support	
Unlock Inhibit Switch .....	In driver's door at lock cylinder	
C200 (10 pin) .....	Under LH dash, on LH side of steering column .....	214-1
C206 (29 pin) .....	Under LH dash, on body electrical bracket .....	157-1
C305 (4 pin) .....	Under left side of dash	
C400 (13 pin) .....	Under dash, above trunk release lever .....	214-4
C401 (13 pin) .....	Right of glove box, above speaker grill .....	206-1
C402 (4 pin) .....	Under dash above trunk release lever .....	213-2
C520 (2 pin) .....	In driver's door	
G200 (Front Interior Ground) ..	On dash frame, left of steering column .....	203-2
G302 (Rear Interior Ground) ....	Under left rear seat .....	212-2

### CHARGING SYSTEM

Diagnostic Connector .....	Top middle of engine .....	101-1
Ignition Switch .....	In upper part of steering column	
Power Distribution Box .....	Top front of left front wheel well .....	204-1
Starter .....	Lower rear left side of engine	
C101 (17 pin) .....	On right side of power distribution box .....	201-2
C200 (10 pin) .....	Under LH dash, on LH side of steering column .....	214-1
C206 (29 pin) .....	Under LH dash, on body electrical bracket .....	157-1
C302 (Accessory Connector) ..	Under LH dash, on body electrical bracket .....	157-1
G104 (Main Body Ground) .....	Left fender, behind headlights .....	201-1

### CIGAR LIGHTER/GLOVE BOX LIGHT/AUTO-CHARGING FLASHLIGHT

Power Distribution Box .....	Top front of left front wheel well .....	204-1
C206 (29 pin) .....	Under LH dash, on body electrical bracket .....	157-1
G200 (Front Interior Ground) ..	On dash frame, left of steering column .....	203-2

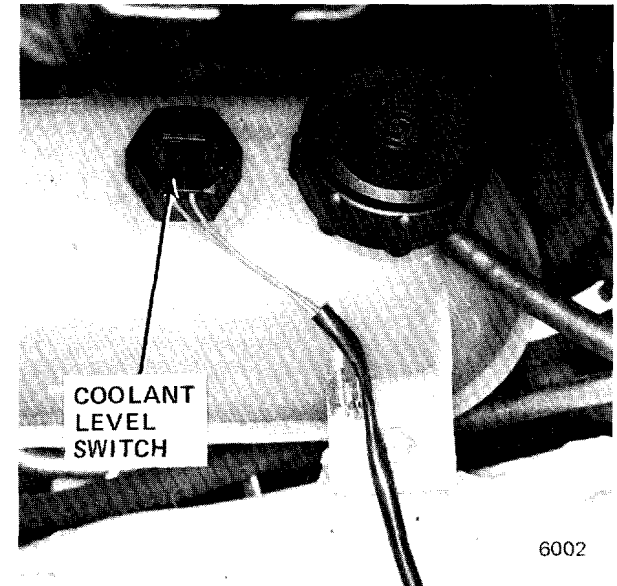

Figure 1 - Right Of Left Front Wheel Well

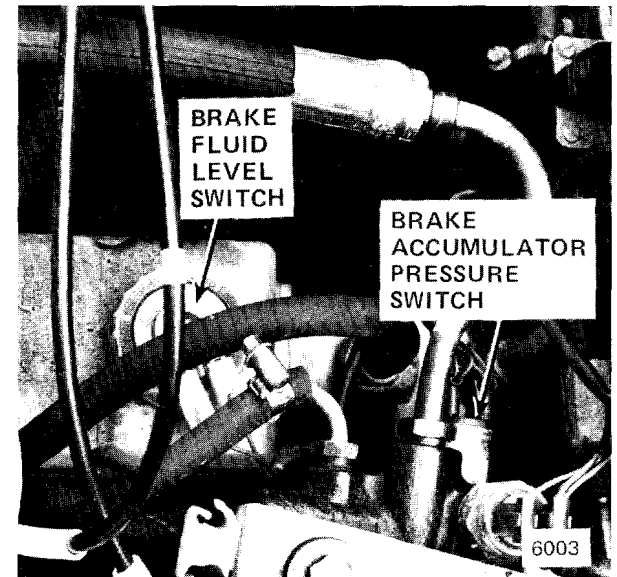

Figure 2 - Left Rear Corner Of Engine Compartment

**FUEL CONTROL/IGNITION (SEE PAGE 205)**

		FIGURE
Air Flow Meter	Top right side of engine	205-1
Auxiliary Fuel Pump	Under trunk, top right side of fuel tank	
Diagnostic Connector	On power distribution box	101-1
Engine Speed Sensor	On transmission bell housing	
Fuel Pump Relay	On right side of power distribution box	204-1
Idle Speed Actuator	Top right side of engine	
Main Fuel Pump	Under car, ahead of left rear axle	
Main Relay	On right side of power distribution box	102-1
Motronic Control Unit	Under right side of dash glove box	211-2
On-Board Computer Relay Box	Under LH side of dash	211-2
Oxygen Sensor	Rear of engine, in exhaust manifold	204-2
Oxygen Sensor Heater Relay	On power distribution box	
Power Distribution Box	Top front of left front wheel well	204-1
TDC Sensor	Above crankshaft vibration damper	
C101 (17 pin)	On right side of power distribution box	201-2
C103 (4 pin)	Under right side of dash, above glove box	211-2
C141 (3 pin)	Rear of engine in exhaust manifold	
C200 (10 pin)	Under LH dash, on LH side of steering column	214-1
C206 (29 pin)	Under LH dash, on body electrical bracket	157-1
G103 (Engine Ground)	Top rear of engine	205-1
G104 (Main Body Ground)	Left fender, behind headlights	201-1
G200 (Front Interior Ground)	On dash frame, left of steering column	
G302 (rear Interior Ground)	Under left rear seat	212-2

**HEADLIGHTS (CONTROL/POWER)/FOG LIGHTS (CONTROL/POWER)**

Combination Switch	On LH side of steering column	
Flasher	Upper left side of steering column	
Power Distribution Box	Top front of left front wheel well	204-1
C102 (12 pin)	In power distribution box	
C126 (2 pin)	Behind left side of front spoiler	
C127 (2 pin)	Behind right side of front spoiler	
C202 (13 pin)	Under LH dash, on LH side of steering column	214-1
G104 (Main Body Ground)	Left fender, behind headlights	201-1
G200 (Front Interior Ground)	On dash frame, left of steering column	203-2
G201 (Column Ground)	Upper left side of steering column	

FIGURE

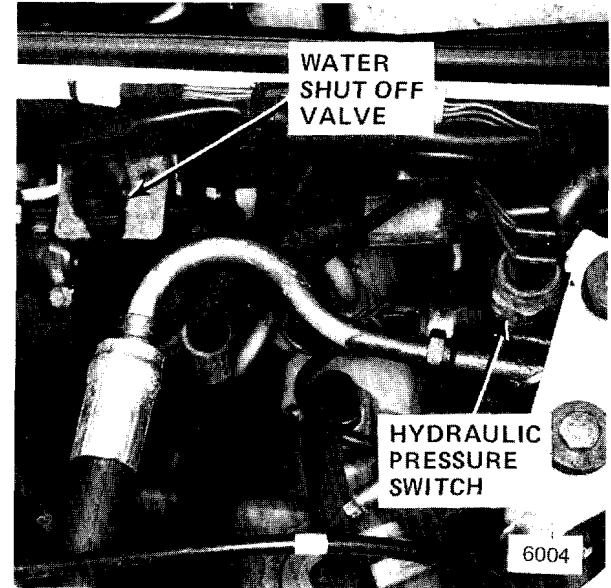

Figure 1 - Left Rear Corner Of Engine Compartment



Figure 2 - Under Dash, Left Of Steering Column



## HEATER/AIR CONDITIONING

		FIGURE
A/C Blower Housing .....	Behind center console	
Blower Select Relay .....	Under dash, left of glove box .....	213-1
Evaporator Temp. Regulator ...	On left side of heater-A/C unit .....	213-6
Evaporator Temperature Sensor	In center console, below radio	
Heater Blower Housing .....	Behind center console	
Heater Regulator .....	Behind temperature select control	
Heater Temperature Sensor ...	On left side of heater-A/C unit .....	213-6
High Pressure Cut-out Switch..	On receiver-dryer .....	207-2
Interior Temperature Sensor ...	In left under dash cover .....	213-4
Motronic Control Unit .....	Under right side of dash above glove box .....	211-2
Power Distribution Box .....	Top front of left front wheel well .....	204-7
Water Shutoff Valve .....	Center rear of engine compartment .....	203-1
C102 (12 pin) .....	In power distribution box	
C103 (4 pin) .....	Under right side of dash above glove box	
C105 (1 pin) .....	Right of right front shock tower .....	209-2
C106 (1 pin) .....	Behind right headlights .....	209-1
C128 (1 pin) .....	Under right side of dash, above glove box	
C204 (13 pin) .....	Behind center console	
C205 (1 pin) .....	Under left side of dash .....	
C206 (29 pin) .....	Under LH dash, on body electrical bracket .....	157-1
C302 (Accessory Connector) ..	Under LH dash, on body electrical bracket .....	157-1
G200 (Front Interior Ground) ..	On dash frame, left of steering column .....	203-2

### FIGURE

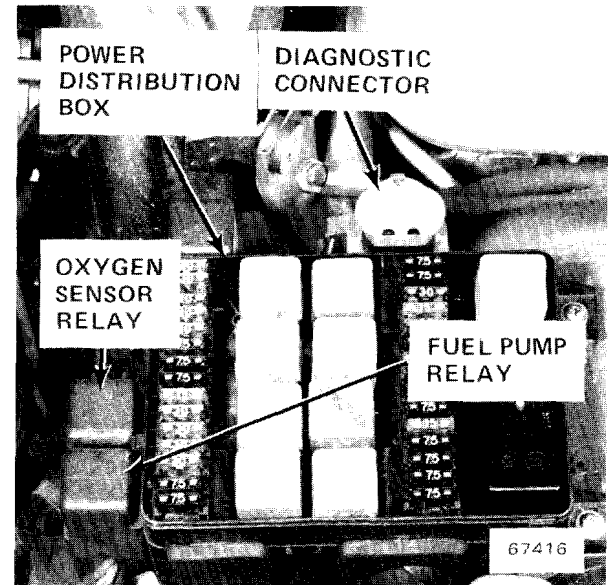

Figure 1 - Top Of Left Front Wheel Well

## HORN/HEATED DOOR LOCK

Horn Brush/Slip Ring .....	Under hub of steering wheel	
Horn Switches .....	Under hub of steering wheel	
Lock Heater .....	In left front door	
Lock Heater Control Unit .....	In left front door	
Power Distribution Box .....	Top front of left front wheel well .....	204-1
C202 (13 pin) .....	Under LH dash, on LH side of steering column .....	214-1
C400 (13 pin) .....	Under dash, above trunk release lever .....	214-4
C503 (8 pin) .....	In driver's door	
C560 (2 pin) .....	In driver's door	
G104 (Main Body Ground) .....	Left fender, behind headlights .....	201-1
G200 (Front Interior Ground) ..	On dash frame, left of steering column .....	203-2
G201 (Column Ground) .....	Upper left side of steering column	

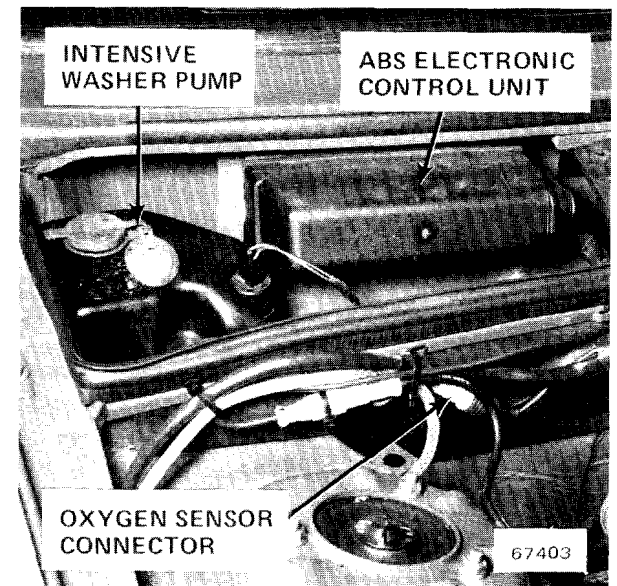

Figure 2 - Below Right Side Of Windshield

**FUEL CONTROL/IGNITION**

Auto. Trans. Range Switch . . . .	On left side of shift lever	
Coolant Temperature Sensor ..	Front of engine, top of thermostat housing . . . . .	213-3
Diagnostic Connector . . . . .	Top middle of engine . . . . .	101-1
Ignition Coil . . . . .	On right wheel well, behind headlights . . . . .	207-1
Ignition Switch . . . . .	In upper part of steering column	
Motronic Control Unit . . . . .	Under right side of dash, above glove box . . . . .	211-2
Reference Point Sensor . . . . .	On transmission bell housing . . . . .	205-1
Throttle Switch . . . . .	Top LH side of engine, below throttle body . . . . .	214-3
C101 (17 pin) . . . . .	On right side of power distribution box . . . . .	201-2
C132 (4 pin) . . . . .	Under right side of dash, above glove box	
C200 (10 pin) . . . . .	Under LH dash, on LH side of steering column . . . . .	214-1
G200 (Front Interior Ground) . . . .	On dash frame, left of steering column	

**FIGURE**

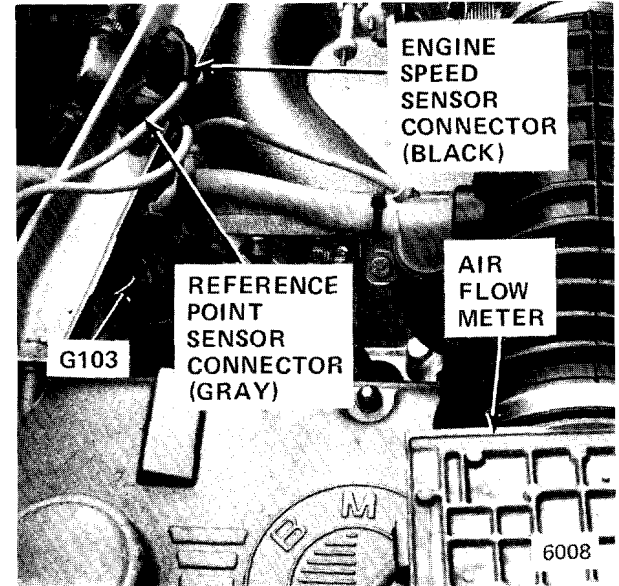

Figure 1 - Top Rear Of Engine

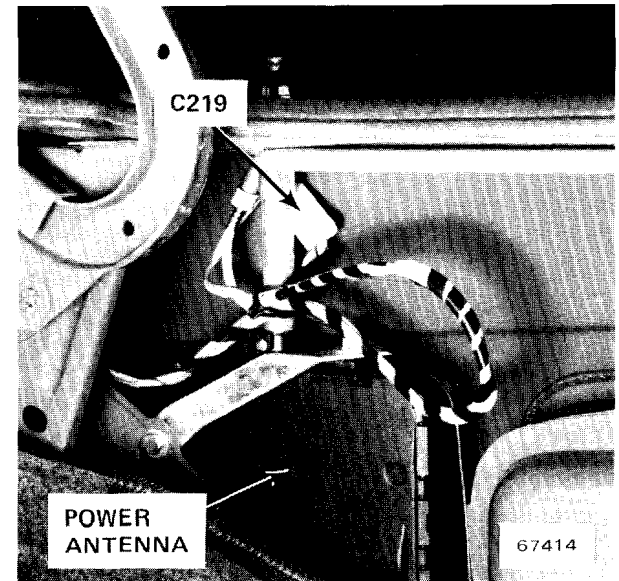

Figure 2 - Right Side Of Trunk

**IGNITION KEY WARNING/SEATBELT WARNING**

**FIGURE**

Ignition Key Switch.....	In upper part of steering column	
Power Distribution Box .....	Top front of left front wheel well .....	204-1
Seatbelt Switch .....	In driver's seatbelt buckle	
Seatbelt Warning Timer .....	Under LH dash, on body electrical bracket	
C200 (10 pin) .....	Under LH dash, on LH side of steering column .....	214-1
C203 (2 pin) .....	Above steering column lower cover	
C206 (29 pin) .....	Under LH dash, on body electrical bracket.....	<del>157-1</del>
C220 (13 pin) .....	Under LH dash, on body electrical bracket.....	<del>157-1</del>
G200 (Front Interior Ground) ..	On dash frame, left of steering column.....	203-2

**INTERIOR LIGHTS**

Interior Light Timer Control ...	Under LH dash, on body electrical bracket	
Lock Heater Control Unit .....	In left front door	
Power Distribution Box .....	Top front of left front wheel well .....	204-1
C206 (29 pin) .....	Under LH dash, on body electrical bracket.....	157-1
C302 (Accessory Connector)...	Under LH dash, on body electrical bracket.....	157-1
C400 (13 pin) .....	Under dash, above trunk release lever .....	214-4
C503 (8 pin) .....	In driver's door	
G200 (Front Interior Ground) ..	On dash frame, left of steering column.....	203-2
G302 (Rear Interior Ground)...	Under left rear seat .....	212-2
G303 .....	Above left B pillar	

**LIGHTS: FRONT PARK/TAIL/UNDERHOOD**

Power Distribution Box .....	Top front of left front wheel well .....	204-1
Rear Lights Check Relay .....	In trunk, left of rear panel center support .....	210-2
Underhood Light Switch .....	Left of right hood hinge	
C102 (12 pin) .....	In power distribution box	
C110 (2 pin) .....	Ahead of right headlights cover	
C206 (29 pin) .....	Under LH dash, on body electrical bracket.....	157-1
G104 (Main Body Ground) .....	Left fender, behind headlights .....	201-1
G302 (Rear Interior Ground)...	Under left rear seat .....	212-2

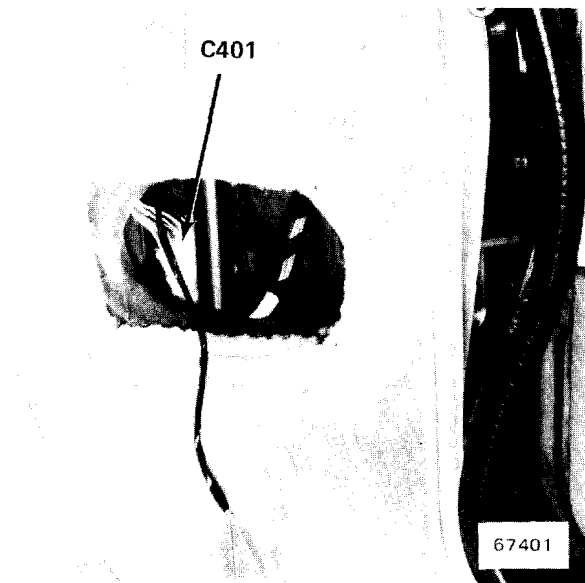

Figure 1 - Behind Right Front Speaker

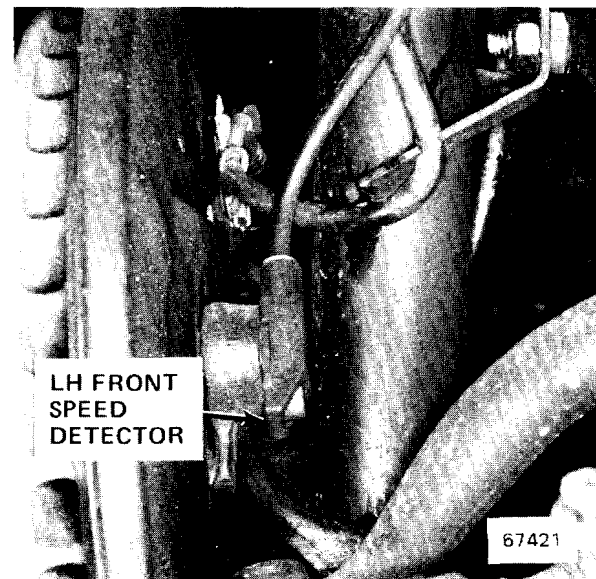

Figure 2 - Behind Left Front Wheel

**LIGHTS: REAR MARKER/LICENSE/TRUNK**

		FIGURE
Power Distribution Box .....	Top front of left front wheel well .....	204-1
Rear Lights Check Relay .....	In trunk, left of rear panel center support .....	210-2
Trunk Light Switch .....	In trunk lid, near trunk lock	
C205 (1 pin) .....	Under left side of dash	
C206 (29 pin) .....	Under LH dash, on body electrical bracket.....	157-1
C300 (2 pin) .....	Base of left trunk hinge.....	210-1
C302 (Accessory Connector) ..	Under LH dash, on body electrical bracket.....	157-1
G302 (Rear Interior Ground) ..	Under left rear seat .....	212-2

**LIGHTS: TURN/HAZARD WARNING**

Combination Switch .....	On LH side of steering column	
Flasher .....	Upper left side of steering column	
Power Distribution Box .....	Top front of left front wheel well .....	204-1
C102 (12 pin) .....	In power distribution box	
C202 (13 pin) .....	Under LH dash, on LH side of steering column .....	214-1
C206 (29 pin) .....	Under LH dash, on body electrical bracket.....	157-1
G104 (Main Body Ground) ....	Left fender, behind headlights .....	201-1
G200 (Front Interior Ground) ..	On dash frame, left of steering column.....	203-2
G201 (Column Ground) .....	Upper left side of steering column	
G302 (Rear Interior Ground) ..	Under left rear seat .....	212-2

**LIGHTS: VISOR/DASH/TRANSMISSION RANGE**

Auto. Trans. Range Switch ....	On left side of shift lever	
Power Distribution Box .....	Top front of left front wheel well .....	204-1
C205 (1 pin) .....	Under left side of dash	
C206 (29 pin) .....	Under LH dash, on body electrical bracket.....	157-1
C215 (2 pin) .....	Behind radio	
C255 (1 pin) .....	Ahead of idle speed control unit	
C301 (2 pin) .....	In center console, ahead of shift lever	
C302 (Accessory Connector) ..	Under LH dash, on body electrical bracket.....	157-1
G200 (Front Interior Ground) ..	On dash frame, left of steering column.....	203-2
G306 .....	Top of right A pillar	

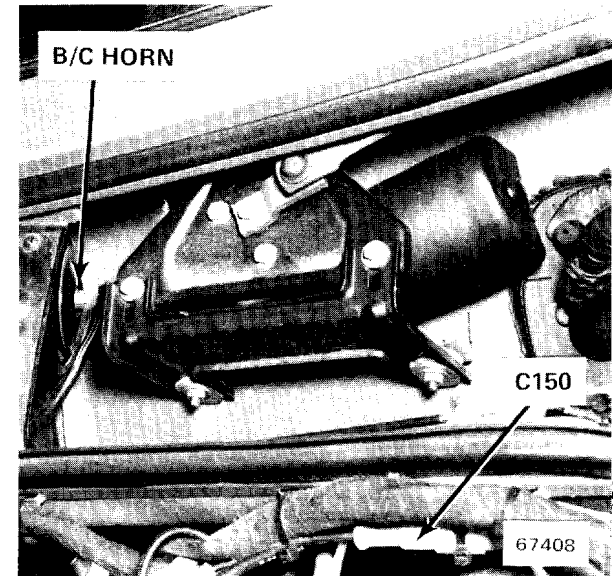

Figure 1 - Under Left Side Of Windshield

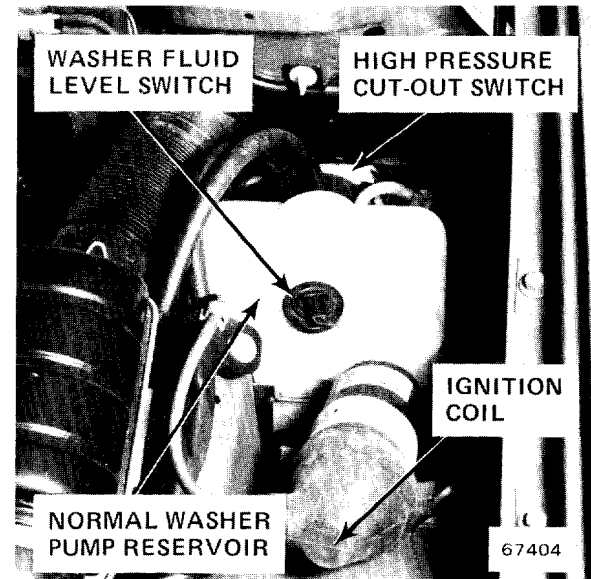

Figure 2 - Ahead Of Right Front Wheel Well

## ON-BOARD COMPUTER

		FIGURE
Alarm Horn Diode .....	Near alarm horn	
Board Computer .....	Under left side of fresh air intake coil	
Chime Module .....	Under dash, left of top of glove box .....	213-3
Fuel Tank Sender Switch.....	Under trunk top right side of fuel tank	
Ignition Switch.....	In upper part of steering column	
Main Relay .....	On right side of power distribution box .....	201-2
Motronic Control Unit.....	Under right side of dash above glove box	
Onboard Computer Relay Box....	Under LH side of dash	
Outside Temperature Sensor.....	Under front bumper, left side	
Power Distribution Box .....	Top front of left front wheel well .....	204-1
C102 (12 pin).....	In power distribution box	
C103 (4 pin).....	Under right side of dash, above glove box.....	212-1
C200 (10 pin).....	Under LH dash, on LH side of steering column .....	214-1
C220 (13 pin).....	Under LH dash, on body electrical bracket	
C302 (Accessory Connector) ..	Under LH dash, on body electrical bracket.....	157-1
G103 (Engine Ground).....	Top rear of engine .....	205-1
G104 (Main Body Ground) ....	Left fender, behind headlights .....	201-1
G200 (Front Interior Ground) ..	On dash frame, left of steering column.....	203-2
G302 (Rear Interior Ground) .....	Under left rear seat .....	212-2

## FIGURE

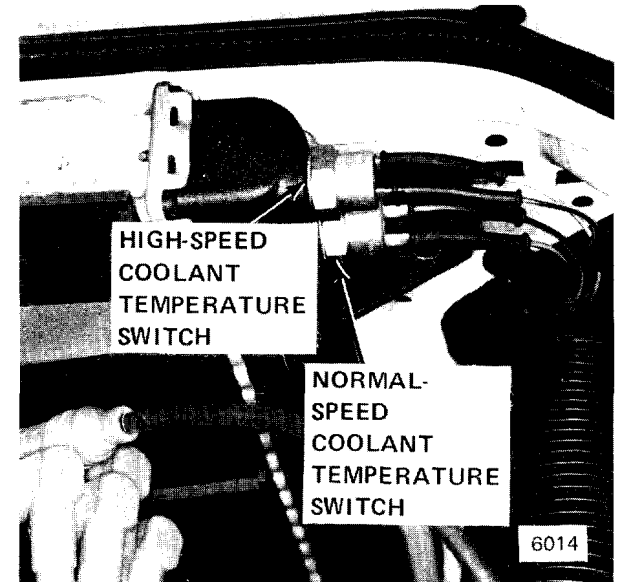

Figure 1 - Top Right Side Of Radiator

## POWER DISTRIBUTION

Diagnostic Connector.....	Top middle of engine.....	101-1
Power Distribution Box .....	Top front of left front wheel well .....	204-1
Starter .....	Lower rear left side of engine	
C102 (12 pin).....	In power distribution box	
C113 (3 pin).....	Left side of auxiliary fan shield	
C126 (2 pin).....	Behind left side of front spoiler	
C127 (2 pin).....	Behind right side of front spoiler	
C200 (10 pin).....	Under LH dash, on LH side of steering column .....	214-1
C206 (29 pin).....	Under LH dash, on body electrical bracket.....	157-1
C220 (13 pin).....	Under LH dash, on body electrical bracket.....	157-1
C302 (Accessory Connector) ..	Under LH dash, on body electrical bracket.....	157-1
G104 (Main Body Ground) ....	Left fender, behind headlights .....	201-1
G200 (Front Interior Ground) ..	On dash frame, left of steering column.....	203-2

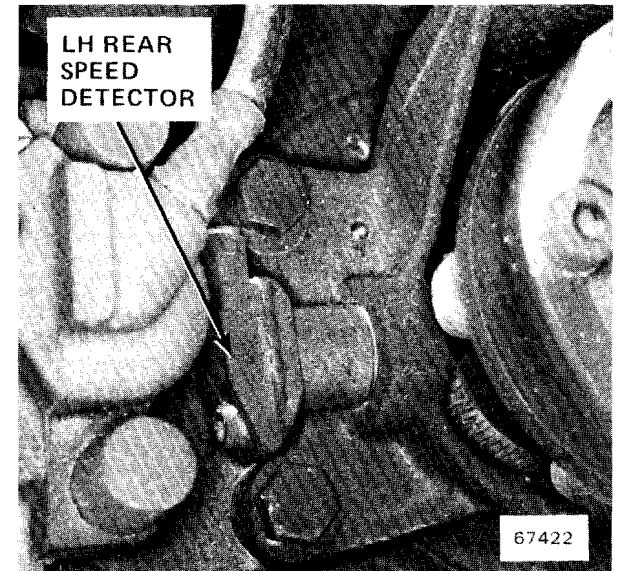

Figure 2 - Behind Left Rear Wheel

**POWER MIRRORS**

Power Distribution Box .....	Top front of left front wheel well .....	204-1
C206 (29 pin) .....	Under LH dash, on body electrical bracket .....	157-1
C400 (13 pin) .....	Under dash, above trunk release lever .....	214-4
C401 (13 pin) .....	Right of glove box, above speaker grill .....	206-1
G200 (Front Interior Ground)	On dash frame, left of steering column .....	203-2

**FIGURE**

**POWER SEATS (SEE PAGE 215)**

**POWER WINDOWS**

Ignition Switch .....	In upper part of steering column	
Power Distribution Box .....	Top front of left front wheel well .....	204-1
Power Window Circuit Breaker	On LH under dash cover	
Window Motors .....	Behind paneling, below window	
C200 (10 pin) .....	Under LH dash, on LH side of steering column .....	214-1
C206 (29 pin) .....	Under LH dash, on body electrical bracket .....	157-1
C400 (13 pin) .....	Under dash, above trunk release lever .....	214-4
C401 (13 pin) .....	Right of glove box, above speaker grill .....	206-1
G302 (Rear Interior Ground)...	Under left rear seat .....	212-2

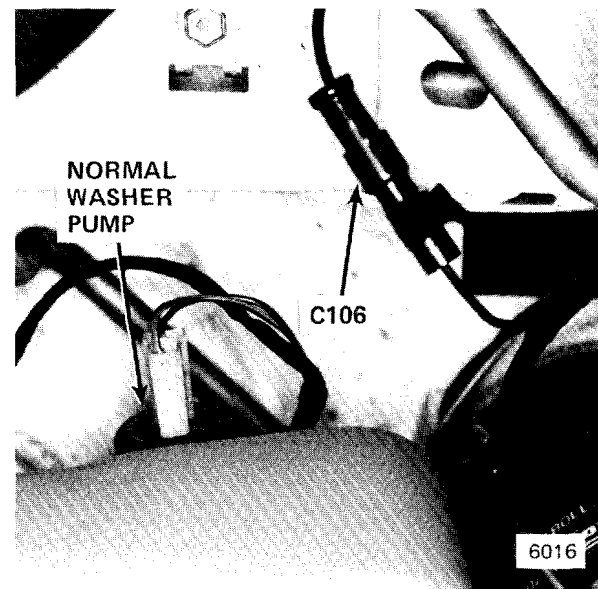

Figure 1 - Ahead Of Right Front Wheel Well

**RADIO/POWER ANTENNA**

Power Distribution Box .....	Top front of left front wheel well .....	204-1
C206 (29 pin) .....	Under LH dash, on body electrical bracket .....	157-1
C215 (2 pin) .....	Behind radio	
C216 (2 pin) .....	Behind radio	
C217 (2 pin) .....	Behind radio	
C218 (2 pin) .....	Behind radio	
C219 (2 pin) .....	RH side of trunk near antenna	
C302 (Accessory Connector) ..	Under LH dash, on body electrical bracket .....	157-1
G200 (Front Interior Ground) ..	On dash frame, left of steering column .....	203-2
G302 (Rear Interior Ground) ..	Under left rear seat .....	212-2

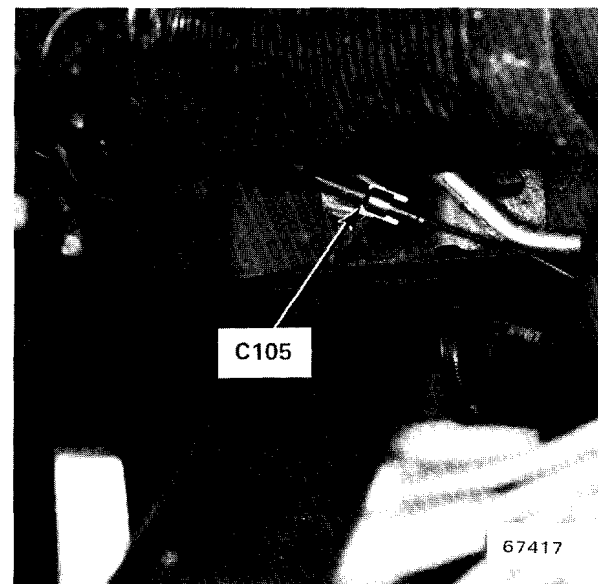

Figure 2 - Top Of Right Front Wheel Well

## 210 COMPONENT LOCATIONS

### REAR DEFOGGER

		FIGURE
Power Distribution Box .....	Top front of left front wheel well .....	204-1
C206 (29 pin) .....	Under LH dash, on body electrical bracket .....	157-1
C302 (Accessory Connector) ..	Under LH dash, on body electrical bracket .....	157-1
G200 (Front Interior Ground) ..	On dash frame, left of steering column .....	203-2
G302 (Rear Interior Ground) ..	Under left rear seat .....	212-2

### SERVICE INTERVAL INDICATOR

Coolant Temperature		
Sender/Switch .....	Front of engine, on thermostat housing .....	213-3
Diagnostic Connector .....	Top middle of engine .....	101-1
Motronic Control Unit .....	Under right side of dash, above glove box .....	211-2
Power Distribution Box .....	Top front of left front wheel well .....	204-1
C101 (17 pin) .....	On right side of power distribution box .....	201-2
C103 (4 pin) .....	Under right side of dash, above glove box .....	211-2
G200 (Front Interior Ground) ..	On dash frame, left of steering column .....	203-2

### SPEEDOMETER/GAUGES/WARNING INDICATORS

Brake Accum. Pres. Switch ....	Right of left front shock tower .....	202-2
Brake Fluid Level Switch .....	To left of engine, on brake fluid reservoir .....	202-2
Coolant Temperature		
Sender/Switch .....	Front of engine, on thermostat housing .....	213-3
Diagnostic Connector .....	Top middle of engine .....	101-1
Fuel Tank Sender .....	Under trunk, top right side of fuel tank	
Hydraulic Pressure Switch .....	Right of left front shock tower .....	203-1
Ignition Switch .....	In upper part of steering column	
Oil Pressure Switch .....	Left rear end of cylinder head	
Park Brake Switch .....	In shift console, at base of parking brake	
Power Distribution Box .....	Top front of left front wheel well .....	204-1
Speedometer Sender .....	In rear of differential	
C101 (17 pin) .....	On right side of power distribution box .....	201-2
C103 (4 pin) .....	Under right side of dash, above glove box .....	211-2
C200 (10 pin) .....	Under LH dash, on LH side of steering column .....	214-1
C206 (29 pin) .....	Under LH dash, on body electrical bracket .....	157-1
G200 (Front Interior Ground) ..	On dash frame, left of steering column .....	203-2
G302 (Rear Interior Ground) ..	Under left rear seat .....	212-2

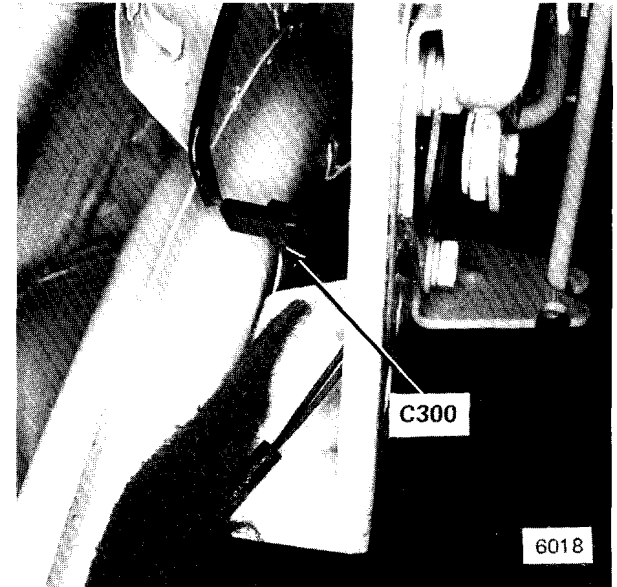

Figure 1 - Left Of Left Trunk Hinge

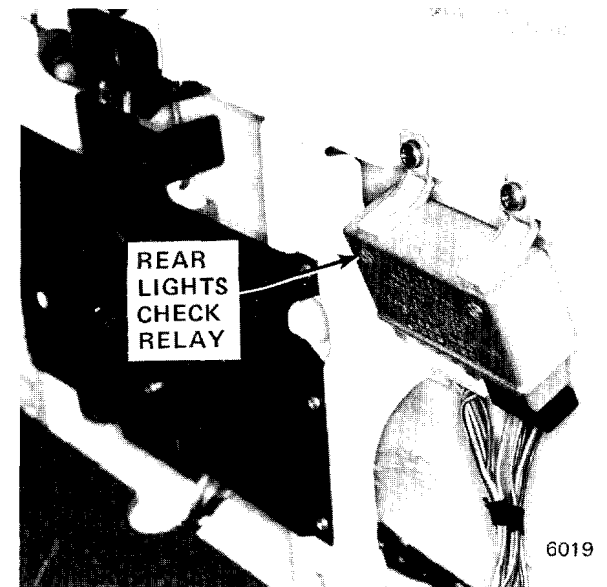

Figure 2 - Rear Panel Of Trunk

**START**

Auto. Trans. Range Switch ....	On left side of shift lever	
Cold Start Valve .....	Between intake ports 3 and 4	
Diagnostic Connector.....	Top middle of engine.....	101-1
Ignition Switch.....	In upper part of steering column,	
Motronic Control Unit.....	Under right side of dash above glove box .....	211-2
Power Distribution Box .....	Top front of left front wheel well .....	204-1
Start Relay .....	Under LH dash, on body electrical bracket	
Starter .....	Lower rear left side of engine	
Thermo Time Switch.....	Front of engine, top of thermostat housing .....	213-5
C101 (17 pin).....	On right side of power distribution box .....	201-2
C200 (10 pin).....	Under LH dash, on LH side of steering column .....	214-1
C241 (1 pin).....	Under LH dash, near body electrical bracket	
G104 (Main Body Ground)....	Left fender, behind headlights .....	201-1
G200 (Front Interior Ground) ..	On dash frame, left of steering column.....	203-2

**FIGURE**

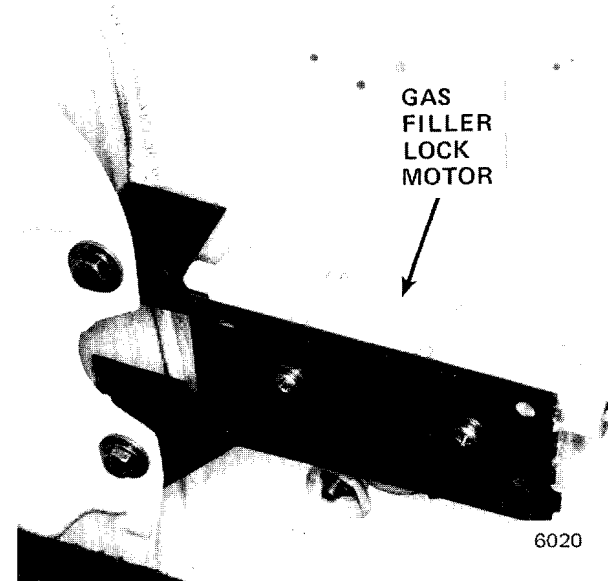

Figure 1 - Rear Of Right Rear Wheel Well

**STOPLIGHTS/CRUISE CONTROL**

Auto. Trans. Range Switch ....	On left side of shift lever	
Brake Switch .....	Above brake pedal .....	213-5
Clutch Switch .....	Above clutch pedal.....	213-5
Cruise Control Actuator.....	Below hydraulic fluid reservoir.....	201-2
Cruise Control Control Unit ...	Under dash, left of top of glove box .....	214-5
Power Distribution Box .....	Top front of left front wheel well .....	204-1
Rear Lights Check Relay .....	In trunk, left of rear panel center support .....	210-2
C206 (29 pin).....	Under LH dash, on body electrical bracket.....	157-1
C208 (2 pin) .....	Above clutch pedal .....	214-2
C209 (7 pin) .....	Under LH dash, ahead of body electrical bracket ....	157-1
C210 (4 pin) .....	Under LH dash, on LH side of steering column .....	214-1
C220 (13 pin).....	Under LH dash, on body electrical bracket	
C301 (2 pin) .....	In center console, ahead of shift lever	
C302 (Accessory Connector) ..	Under LH dash, on body electrical bracket.....	157-1
G200 (Front Interior Ground) ..	On dash frame, left of steering column.....	203-2
G302 (Rear Interior Ground) ..	Under left rear seat .....	212-2

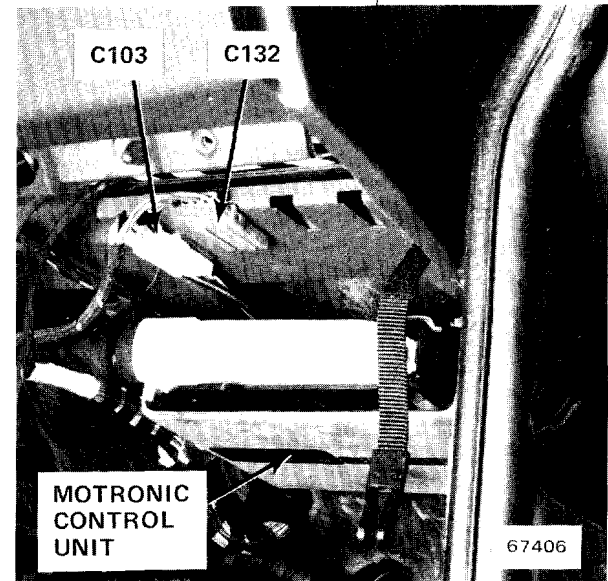

Figure 2 - Behind Dash, Above Glove Box



## 212 COMPONENT LOCATIONS

### SUNROOF

		FIGURE
Power Distribution Box .....	Top front of left front wheel well .....	204-1
Sunroof Motor .....	Above headliner, above rear view mirror	
Sunroof Motor Relay .....	Above headliner, above rear view mirror	
C220 (13 pin) .....	Under LH dash, on body electrical bracket .....	157-1
C302 (Accessory Connector) ..	Under LH dash, on body electrical bracket .....	157-1
G600 .....	Above headliner, above rear view mirror	

### WINDSHIELD WASHER JET HEATERS

Jet Heaters .....	On washer jet nozzles	
Normal Washer Pump .....	Bottom of normal washer pump reservoir .....	209-1
Power Distribution Box .....	Top front of left front wheel well .....	204-1
C102 (12 pin) .....	In power distribution box	
C110 (2 pin) .....	Ahead of right headlights cover	
G106 .....	Near normal washer pump reservoir	

### WIPER/WASHER HEATED JETS

Intensive Washer Pump .....	Behind right front shock tower .....	204-2
Normal Washer Pump .....	Bottom of normal washer pump reservoir .....	209-1
Power Distribution Box .....	Top front of left front wheel well .....	209-1
Wiper Motor .....	Under left side fresh air intake cowl	
C102 (12pin) .....	In power distribution box	
C201 (6 pin) .....	Under LH dash, on LH side of steering column .....	214-1
G201 (Column Ground) .....	Upper left side of steering column	

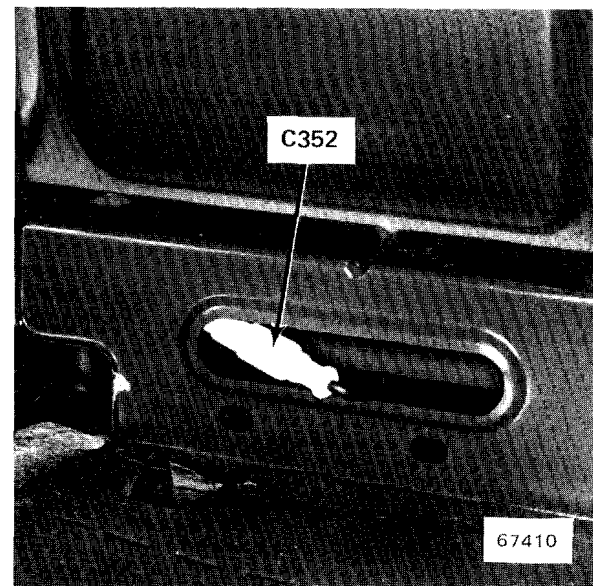

Figure 1 - LH Front Of Trunk

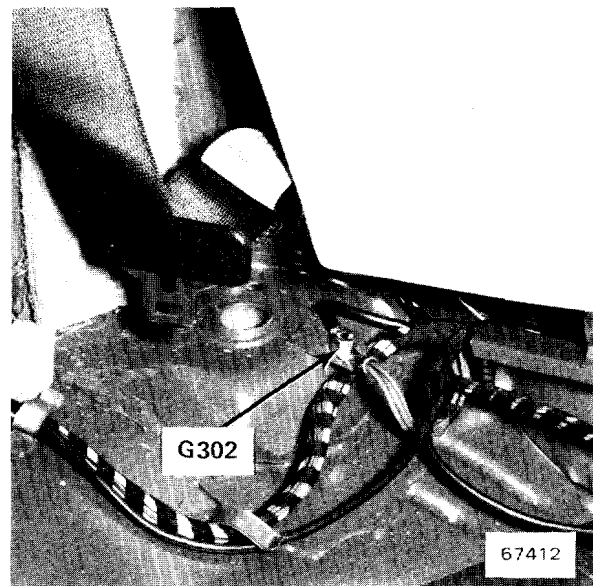

Figure 2 - Under Left Rear Seat

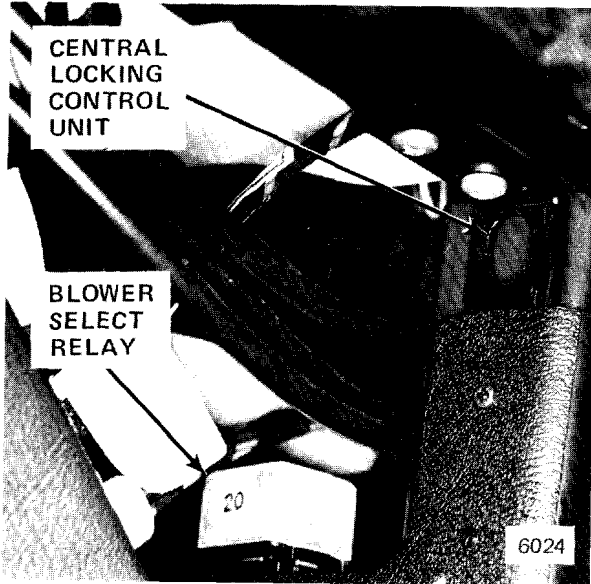

Figure 1 - Behind Dash, Left Of Glove Box

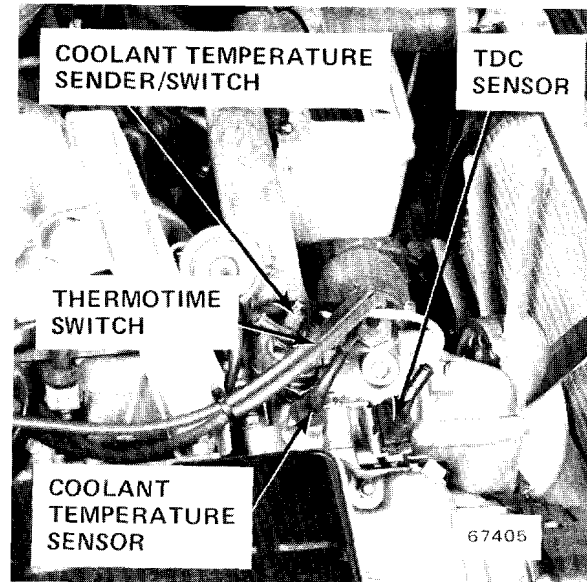

Figure 3 - Top Front Of Engine

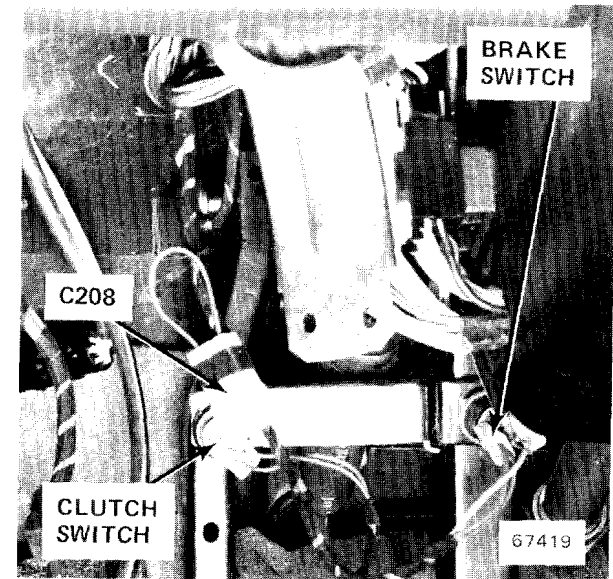

Figure 5 - Driver's Footwell, Above Brake Pedal

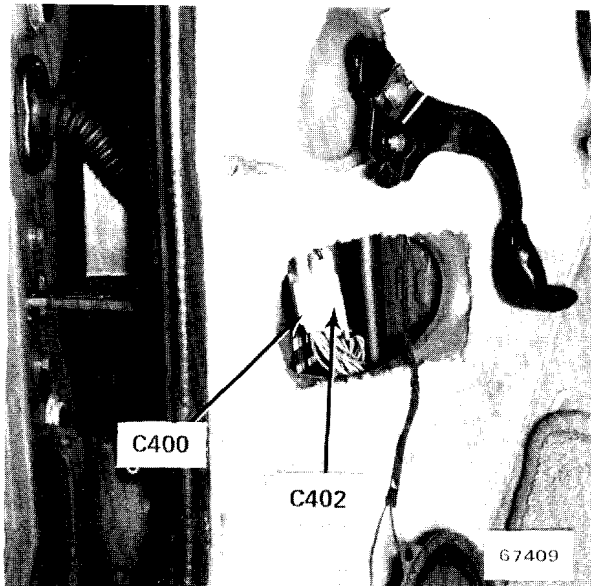

Figure 2 - Behind Dash, Above Left Side Of Glove Box

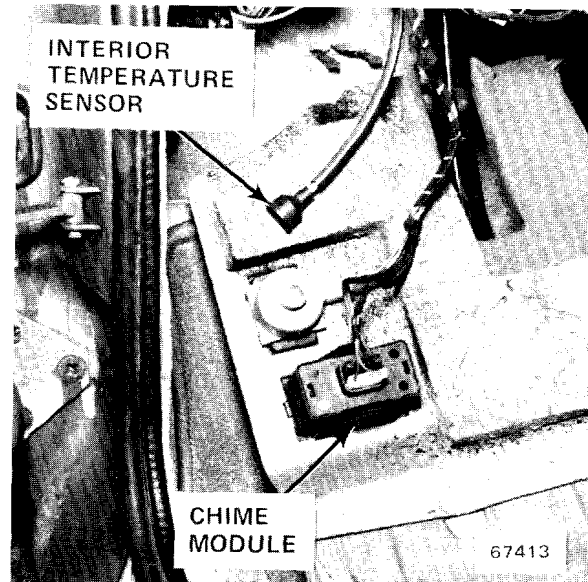

Figure 4 - Behind Dash, Left Of Steering Column

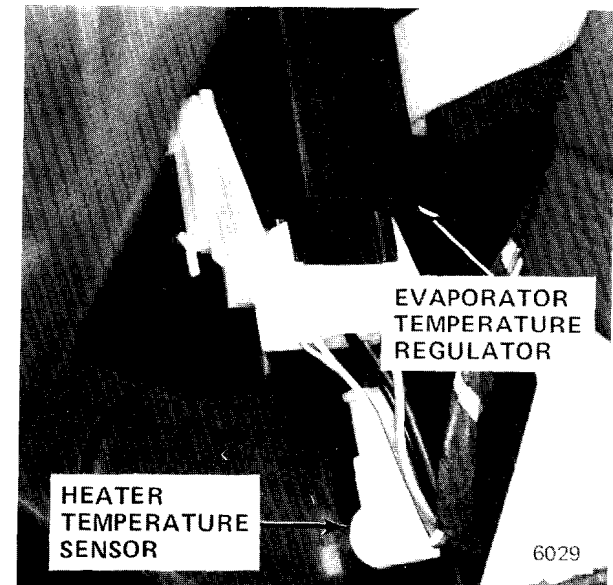

Figure 6 - Behind Left Side Of Console

# 214 COMPONENT LOCATIONS

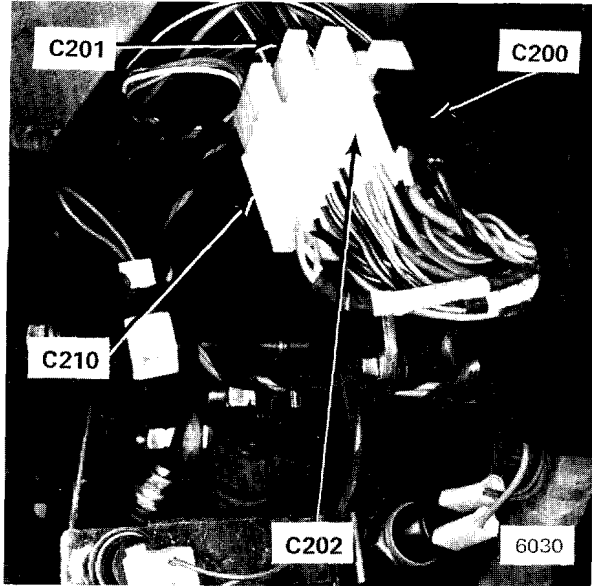

Figure 1 - Driver's Footwell, Above Brake Pedal

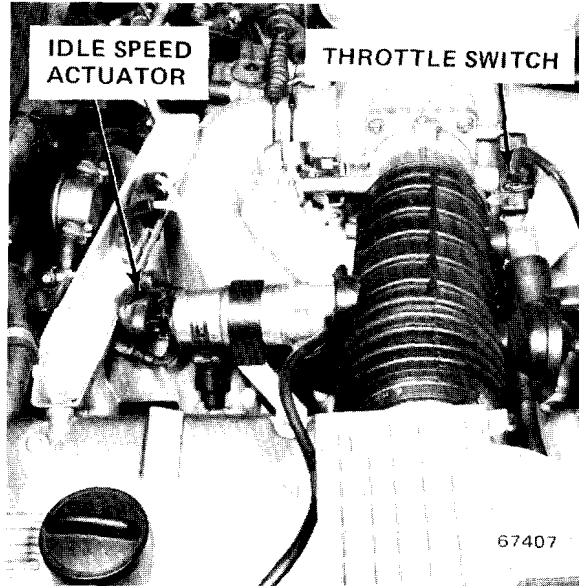

Figure 3 - Top Center Of Engine

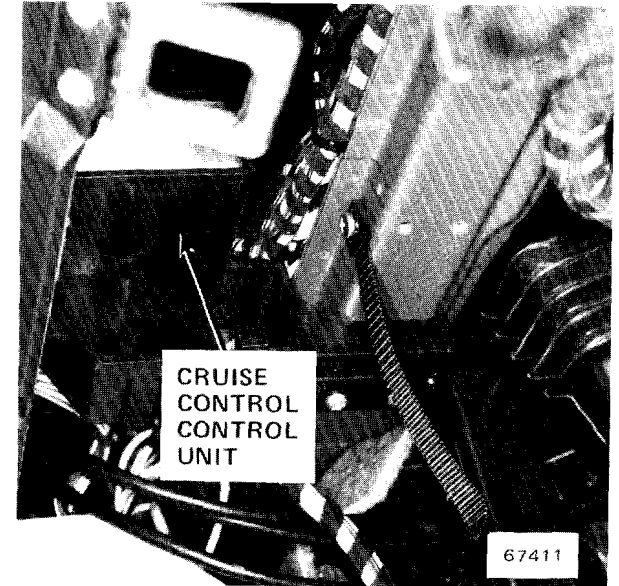

Figure 5 - Below Glove Box



Figure 2 - Driver's Footwell, Above Brake Pedal

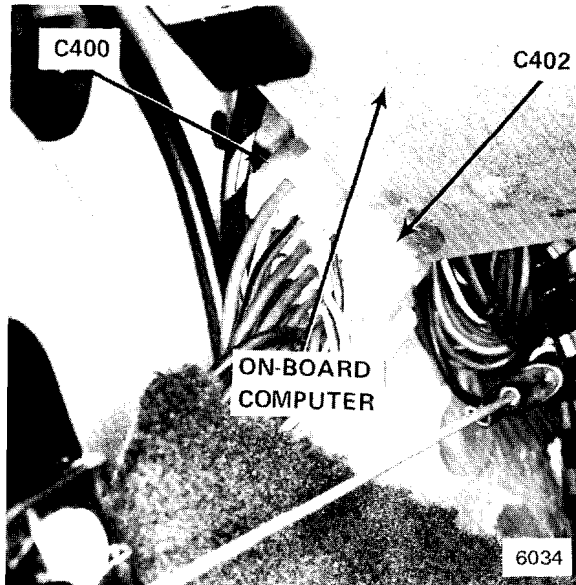

Figure 4 - Behind Dash, Above Left Front Speaker

**POWER SEATS**

**FIGURE**

Driver’s Seat Controller . . . . .	Under driver’s seat, on frame	
Passenger’s Seat Controller . . . . .	Under passenger’s seat, on frame	
C220 (13 pin) . . . . .	Under LH dash on body electrical bracket . . . . .	157-1
C302 (Accessory Connector) . . . . .	Under LH dash on body electrical bracket . . . . .	157-1
C551 (2 Pin) . . . . .	Under center console	
G200 (Front Interior Ground) . . . . .	On dash frame, left of steering column. . . . .	203-2

**ANTILOCK BRAKING SYSTEM (ABS)**

Brake Switch . . . . .	Above brake pedal . . . . .	213-5
ABS Electronic Control Unit . . . . .	Below right side of windshield	
ABS Hydraulic Unit . . . . .	Right of left front wheel well	
Rear Lights Check Relay . . . . .	In trunk left of rear panel center support . . . . .	210-2
Diagnostic Connector . . . . .	On power distribution box . . . . .	101-1
C200 (10 pin) . . . . .	Under LH dash on LH side of steering column . . . . .	214-1
C206 (29 pin) . . . . .	Under LH dash on body electrical bracket . . . . .	157-1
C302 (Accessory Connector) . . . . .	Under LH dash on body electrical bracket	
C101 (17 pin) . . . . .	On right side of power distribution box . . . . .	201-2
C150 (2 pin) . . . . .	Behind LH front shock tower	
C151 (2 pin) . . . . .	Behind RH front shock tower	
C351 (2 pin) . . . . .	RH front of trunk	
C352 (2 pin) . . . . .	LH front of trunk	
G302 (Rear Interior Ground) . . . . .	Under left rear seat . . . . .	212-2

**BLANK**

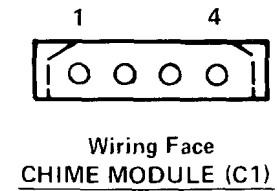
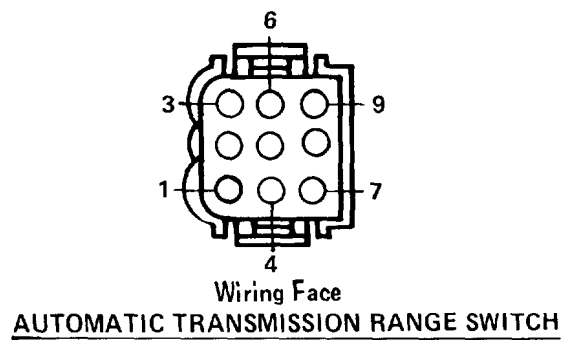
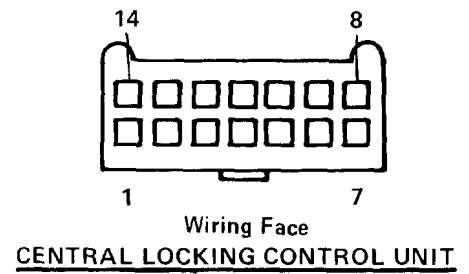
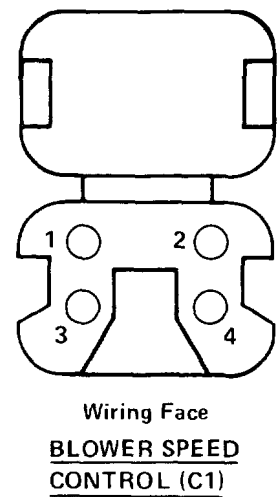
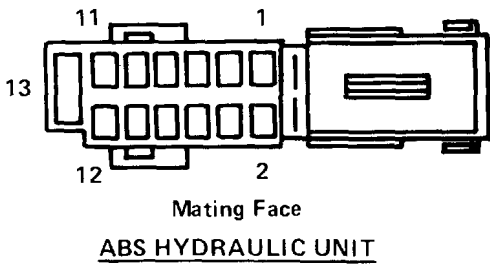
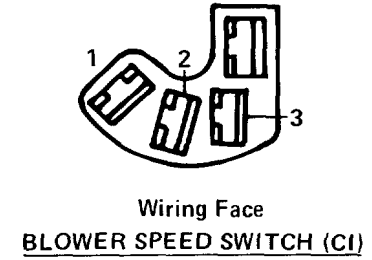
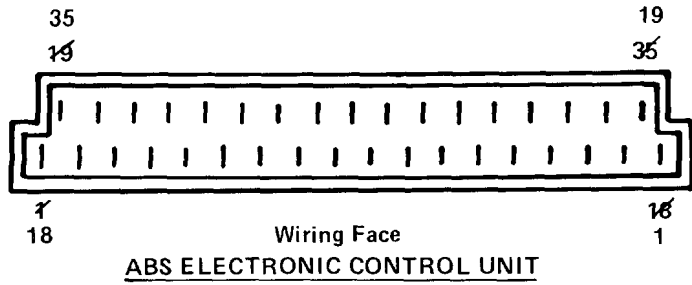

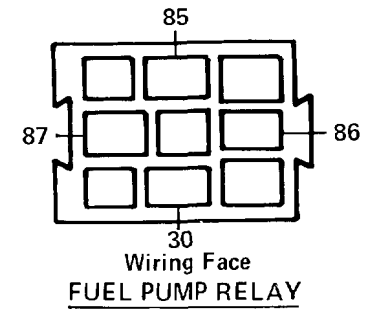
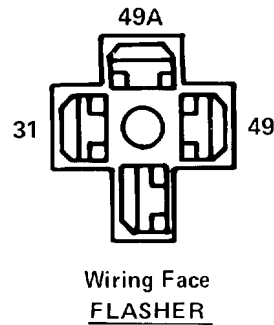
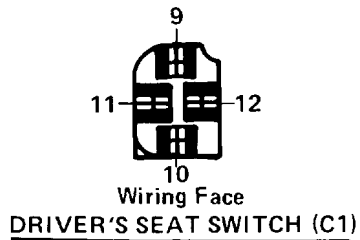
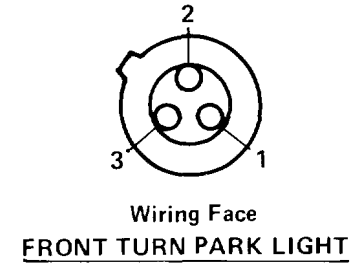
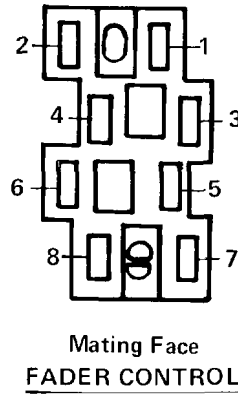
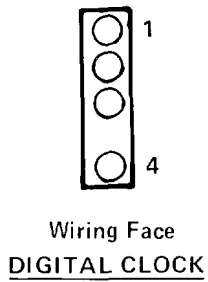
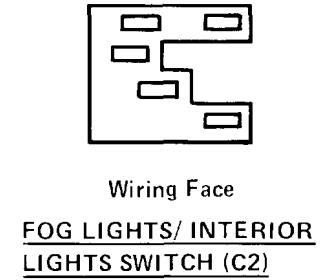
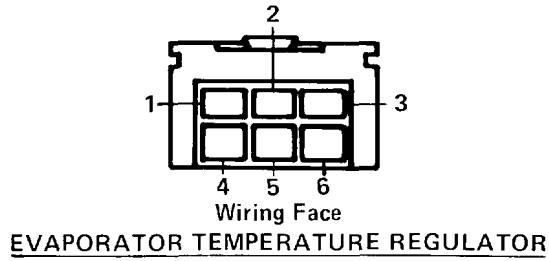
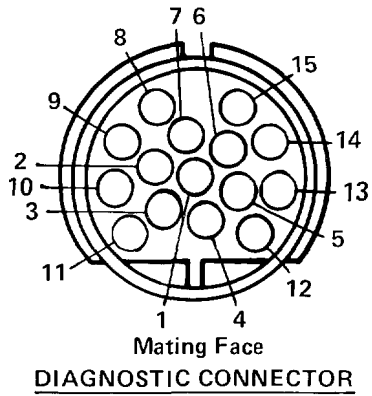

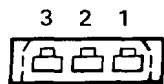

Wiring Face  
FUEL TANK SENDER

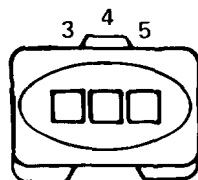

Wiring Face  
IDLE SPEED ACTUATOR

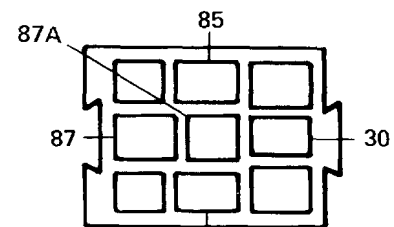

Wiring Face  
MAIN RELAY

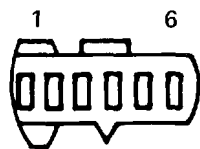

Wiring Face  
GAS FILLER LOCK MOTOR

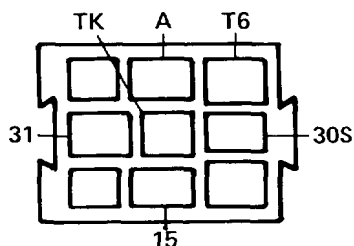

Wiring Face  
INTERIOR LIGHT TIMER CONTROL

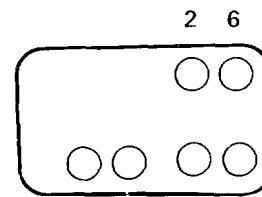

Mating Face  
MIRROR CONTROL SWITCH

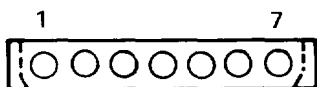

Wiring Face  
HEATER REGULATOR

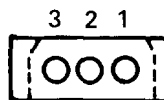

Wiring Face  
INTERIOR TEMPERATURE SENSOR

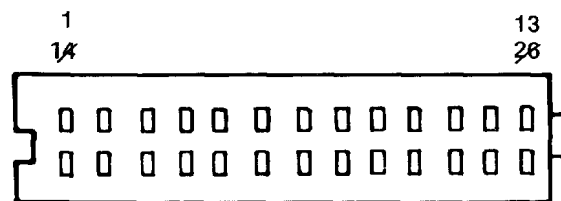

Wiring Face  
ON BOARD COMPUTER MODULE



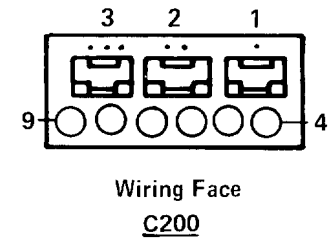
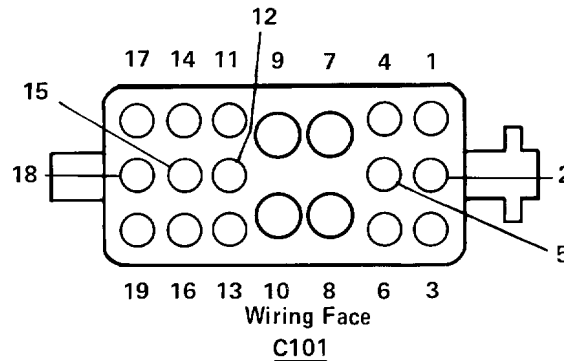
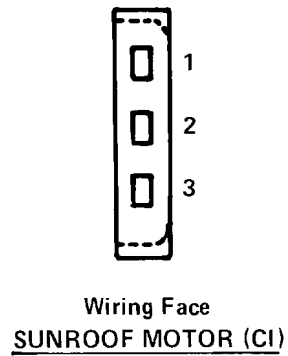
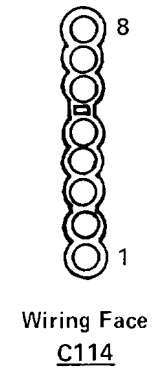
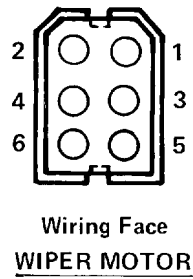
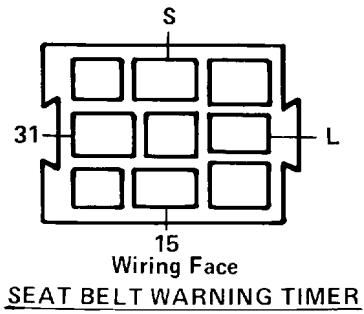
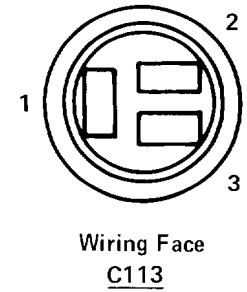
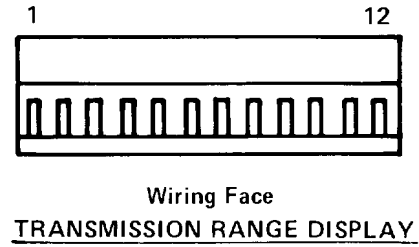
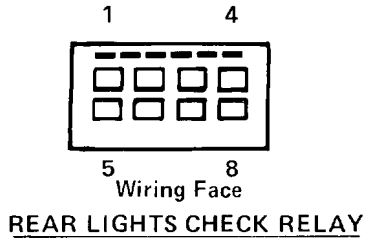

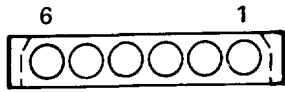

Wiring Face  
C201

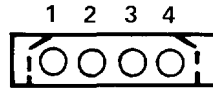

Wiring Face  
C210

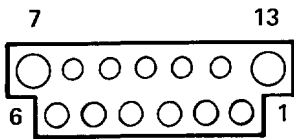

Wiring Face  
C202

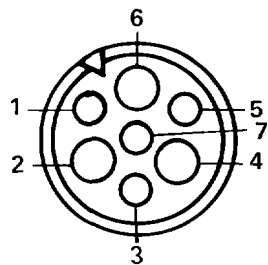

Wiring Face  
C209