

1990

BMW M3

Electrical

Troubleshooting

Manual

BMW of North America, Inc.
Woodcliff Lake, New Jersey

FOREWORD

In the interests of continuing technical development work we reserve the right to modify designs and equipment.

Printed in USA

©Copyright BMW of North America, Inc.

Not to be reproduced wholly or in part
without written permission of BMW of
North America, Inc.

PN 89 89 1 000 333

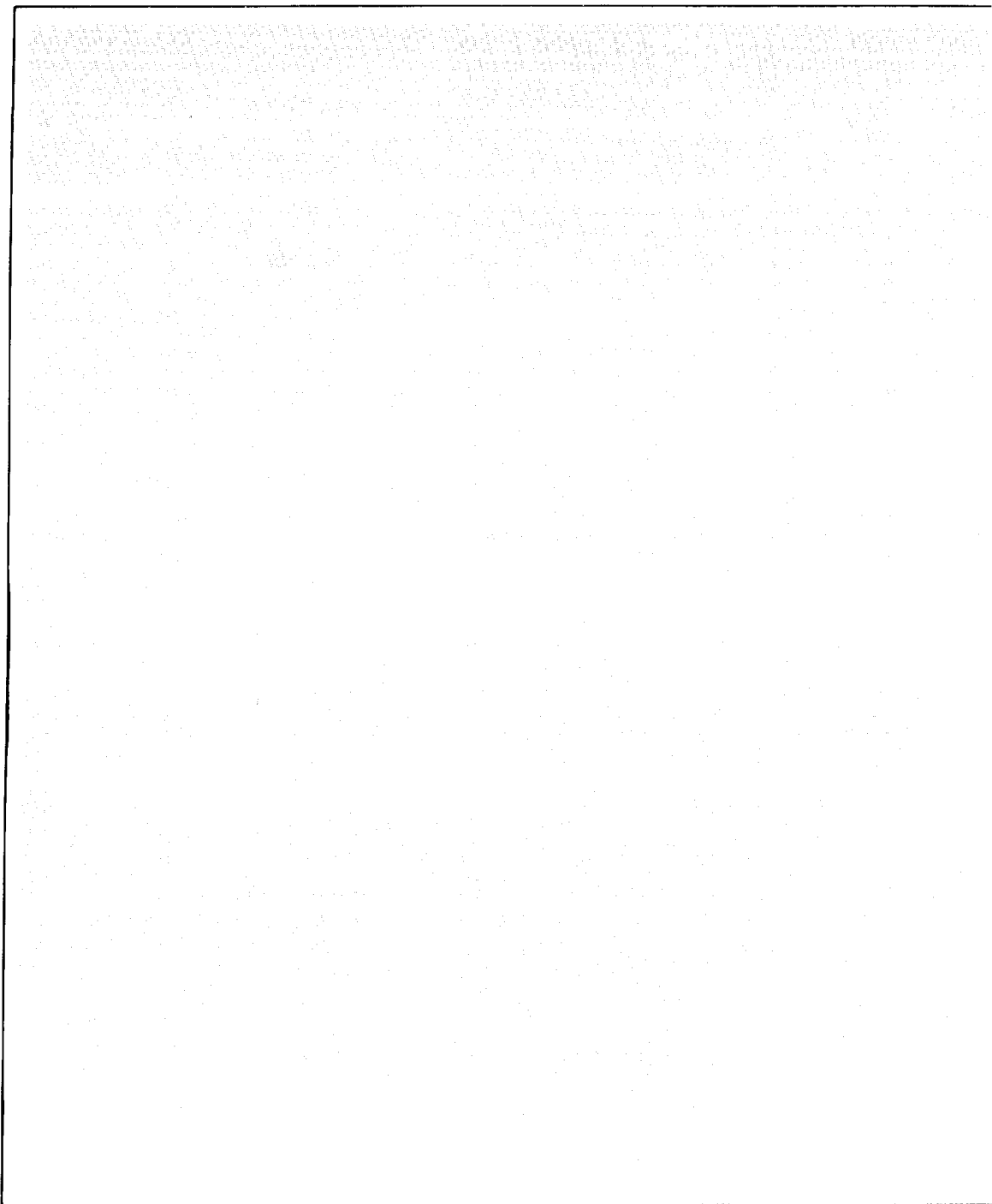

**1990
BMW M3
Electrical
Troubleshooting
Manual**

CONTENTS

Index	2
How To Use This Manual	3
Wire Size Conversion Chart . . .	3
Symbols	4
Systematic Troubleshooting . .	6
Connector Views	8500-0
Power Distribution Box	0670-0
Fuse Data	0670-1
Component Location Chart . . .	9000-0
Component Location Views . .	7000-0
Splice Location Views	8000-0

Index — Alphabetical Listing of Electrical Circuits

	PAGE		PAGE		PAGE
Active Check Control	6216-0	— G201	0670-14	— Hazard Switch	6313-0
A/C Air Delivery Control	6421-0	— G300	0670-15	— Headlights	6312-0
A/C Blower Controls	6413-0	Heated Seats	5200-0	— Instrument Cluster	6300-1
A/C Compressor Controls	6452-0	Horns	6100-0	— Interior	6330-0
A/C Temperature Control	6411-0	Ignition Key Warning	6131-0	— License	6320-0
Antilock Brake	3450-0	Indicators		— Map Reading Light	6100-1
Auto-Charging Flashlight	6100-1	— ABS	3450-0	— Rear Ashtray	6300-1
Auxiliary Fan	6454-0	— Active Check Control Alarm	6216-1	— Rear Side Marker	6320-0
Auxiliary Fuse	0670-2	— “Brake Lights” Fault	6216-1	— Stop	6325-0
Brake Warning System	3435-0	— “Brake Lining” Wear	3435-0	— Tail	6314-0
Central Locking	5126-0	— “Brake Warning”	3435-0	— Trunk	6320-0
Charge System	1230-0	— Charge	6210-0	— Turn/Park	6313-1
Cigar Lighter	6100-1	— “Coolant” Level Fault	6216-2	Light Switch Details	6300-0
Component Location Chart	9000-0	— “Engine Oil” Fault	6216-2	On-Board Computer	6581-0
Component Location Views	7000-0	— Fasten Seatbelts	6216-2	Power Distribution	0670-0
Connector Views	8500-0	— Fog Lights	6312-0	Power Distribution Box	0670-0
Cruise Control	6571-0	— High Beam	6210-0	Power Mirrors	5116-0
Fuel Gauge	6210-2	— Inspection	6210-1	Power Windows	5133-0
Fuse Data Chart	0670-1	— LH Turn	6210-0	Radio	6500-0
Fuse Details		— “License Plate” Fault	6216-1	Rear Defogger	6100-2
— Fuse 4	0670-6	— “Low Beam” Fault	6216-0	Seatbelt Warning	6131-0
— Fuse 5	0670-6	— Low Fuel Warning	6210-2	Service Interval Indicator	6210-1
— Fuse 6	0670-6	— Oil Pressure Warning	6210-4	Speedometer	6210-0
— Fuse 8	0670-7	— Oil Service	6210-1	Splice Location Views Index	8000-0
— Fuse 9	0670-11	— “Park Brake”	3435-0	Start	1240-0
— Fuse 10	0670-8	— “Rear Lights” Fault	6216-1	Sunroof	5413-0
— Fuse 12	0670-7	— RH Turn	6210-0	Supplemental Restraint System	
— Fuse 19	0670-7	— “Washer Fluid” Fault	6216-2	— (SRS).	3234-0
— Fuse 20	0670-9	Injection Electronics S14 Engine	1364-0	Tachometer	6210-3
— Fuse 21	0670-10	Instrument Cluster	6210-0	Temperature Gauge	6210-2
— Fuse 27	0670-11	Lights		Warnings	
Gauges	6210-2	— A/C Control Power	6300-1	— Ignition Key/Seatbelt	6131-0
Ground Distribution		— Backup	6322-0	Wiper/Washer	6160-0
— G103	0670-12	— Cigar Lighter	6300-1		
— G104	0670-13	— Fog	6312-0		
— G106	0670-13	— Front Ashtray	6300-1		
— G200	0670-13	— Front Side Marker	6314-0		
	0670-14	— Front Turn/Park	6314-0		
	0670-15	— Glove Box	6100-1		

The purpose of this manual is to show electrical schematics in a manner that makes electrical troubleshooting easier. Electrical components which work together are shown together on one schematic. The Wiper-Washer schematic, for example, shows all of the electrical components in one diagram. At the top of the page is the fuse (positive) that powers the circuit. The flow of current is shown through all wires, connectors, switches, and motors to ground (negative) at the bottom of the page.

Within the schematic, all switches and sensors are shown "at rest," as though the Ignition Switch were off. For identification, component names are underlined and placed next to or above each component. Notes are included, describing how switches and other components work.

The power distribution schematic shows the current feed through all the connections from the Battery and Alternator to each fuse and the Ignition and Light Switches. If the Power Distribution schematic is combined with any other circuit schematic, a complete picture is made of how that circuit works. The Ground Distribution schematics show how several circuits are connected to common grounds.

All wiring between components is shown exactly as it exists in the vehicle; however, the wiring is not drawn to scale. To aid in understanding electrical operation, wiring inside complicated components has been simplified. The "Solid State" label designates electronic components.

WIRE SIZE CONVERSION CHART	
METRIC (CROSSECTIONAL AREA IN MM ²)	AWG (AMERICAN WIRE GAUGE)
.5	20
.75	18
1	16
1.5	14
2	14
2.5	12
4	10
6	8
8	8
16	4
20	4
25	2
32	2

WIRE INSULATION	
ABBREVIATIONS	COLOR
BK	BLACK
BR	BROWN
RD	RED
YL	YELLOW
GN	GREEN
BU	BLUE
VI	VIOLET
GY	GRAY
WT	WHITE
PK	PINK

4 SYMBOLS



ENTIRE COMPONENT SHOWN



COMPONENT CASE IS DIRECTLY ATTACHED TO METAL PART OF CAR (GROUNDED)



PART OF A COMPONENT SHOWN

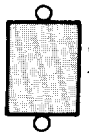

COMPONENT WITH SCREW TERMINALS



SOLID STATE (INCLUDES ONLY ELECTRONIC PARTS)

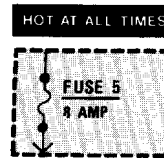

HOT AT ALL TIMES

INDICATES THAT FUSE 5 IS ALWAYS SUPPLIED WITH POWER

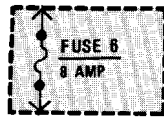

HOT IN RUN OR START

INDICATES THAT FUSE 6 IS SUPPLIED WITH POWER WITH THE IGNITION SWITCH IN THE RUN OR START POSITIONS

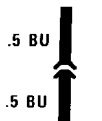
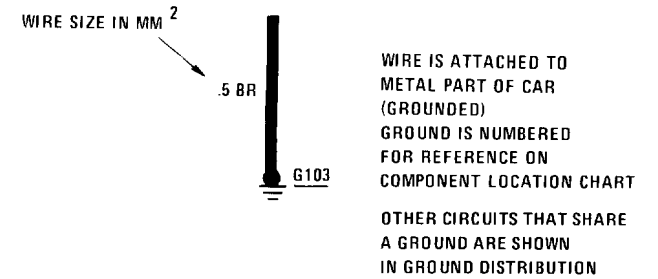
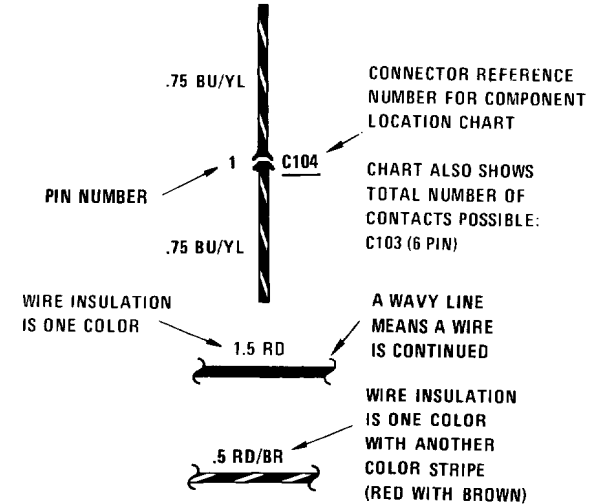

CONNECTOR ON COMPONENT LEAD (PIGTAIL)



CONNECTOR ATTACHED TO COMPONENT

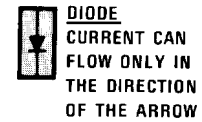
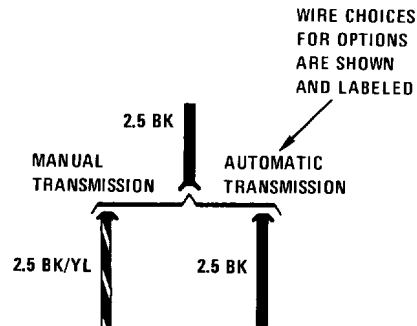

CIRCUIT REFERENCE - A WIRE WHICH CONNECTS TO ANOTHER CIRCUIT



ACTIVE CHECK CONTROL

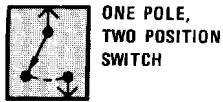

ONE POLE,
TWO POSITION
SWITCH

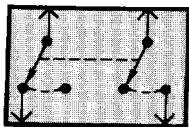

SWITCHES THAT
MOVE TOGETHER
DASHED LINE SHOWS
A MECHANICAL
CONNECTION
BETWEEN SWITCHES

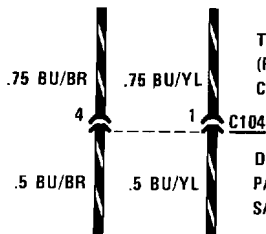

TWO CONNECTIONS
(PINS) IN THE SAME
CONNECTOR

DASHED LINE SHOWS
PARTS OF THE
SAME CONNECTOR

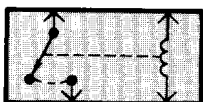

WHEN COIL IS
ENERGIZED, SWITCH
IS PULLED CLOSED

RELAY SHOWN
WITH NO
CURRENT
FLOWING
THROUGH
COIL

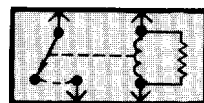

RELAY SHOWN
WITH RESISTOR
ACROSS COIL
RESISTOR ACROSS COIL
IS FOR NOISE
SUPPRESSION

RELAY SHOWN
WITH RESISTOR
ACROSS COIL

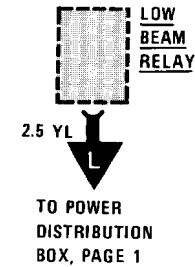
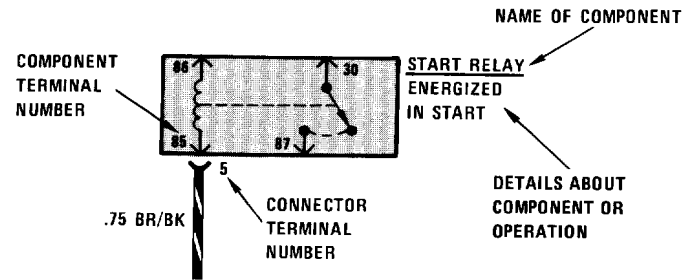

CURRENT PATH
IS CONTINUED
AS LABELED.
THE ARROW SHOWS
DIRECTION OF CURRENT
FLOW AND IS REPEATED
WHERE CURRENT
PATH CONTINUES.

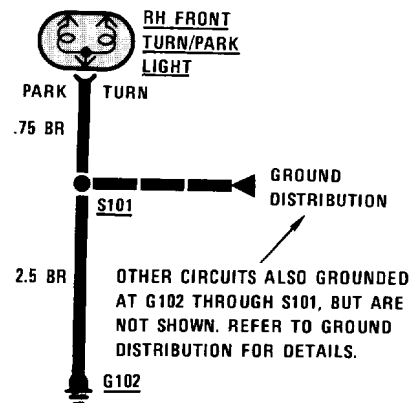
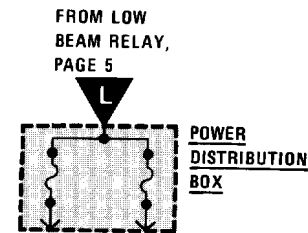
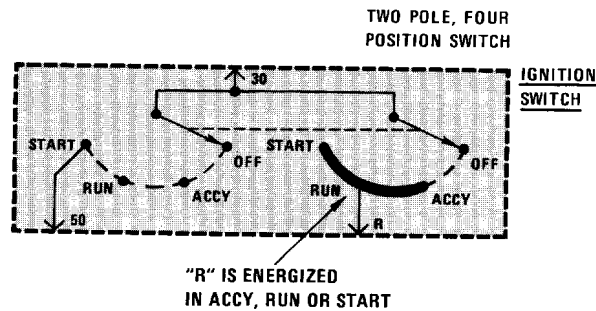

LIGHT
EMITTING
DIODE

6 SYSTEMATIC TROUBLESHOOTING

TROUBLESHOOTING PROCEDURE

1. Verify the Problem

Operate the problem circuit to check the accuracy of the complaint. Note the symptoms of the inoperative circuit.

2. Analyze the Problem

Refer to the schematic of the problem circuit in the ETM. Determine how the circuit is supposed to work by tracing the current path(s) from the power feed through the circuit components to ground. Then based on the symptoms you noted in step 1 and your understanding of circuit operation, identify one or more possible causes of the problem.

3. Isolate the Problem

Make circuit tests to prove or disprove the preliminary diagnosis made in step 2. Keep in mind that a logical simple procedure is the key to efficient troubleshooting. Test for the most likely cause of failure first. Try to make tests at points which are easily accessible.

4. Repair the Problem

Once the specific problem is identified, make the repair using the proper tools and safe procedures.

5. Check the Problem

Operate the circuit to check for satisfactory circuit operation. Good repair practice calls for rechecking all circuits you have worked on.

TROUBLESHOOTING TOOLS

Isolating the problem (Step 3 of TROUBLESHOOTING PROCEDURES) requires the use of a **voltmeter** and/or **ohmmeter**. A voltmeter measures voltage at selected points in a circuit. An ohmmeter measures a circuit's resistance to current flow. It has an internal battery that provides current to the circuit under test. Disconnect the car battery when using an ohmmeter because the battery voltage will cause the ohmmeter to give false readings. Also, do not use an ohmmeter on solid-state components. The voltage that the ohmmeter applies to the circuit could damage these components.

TROUBLESHOOTING TESTS

Voltage Test

This test measures voltage in a circuit. By taking measurements at several points (terminals or connectors) along the circuit, you can isolate the problem.

To take a voltage measurement, connect the negative lead of the voltmeter to the battery's negative terminal or other known good ground. Then connect the positive lead of the voltmeter to the point you want to test. The voltmeter will measure the voltage present at that point in the circuit.

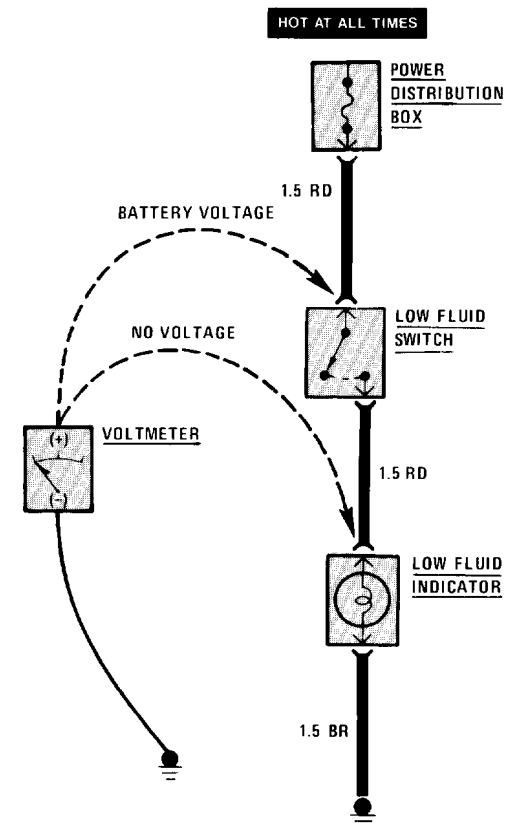

Voltage Test

Voltage Drop Test

Wires, connectors, and switches are designed to conduct current with a minimum loss of voltage. A voltage drop of more than one volt indicates a problem.

To test for voltage drop, connect the voltmeter leads to connectors at either end of the circuit's suspected problem area. The positive lead should be connected to the connector closest to the power source. The voltmeter will show the voltage drop between these two points.

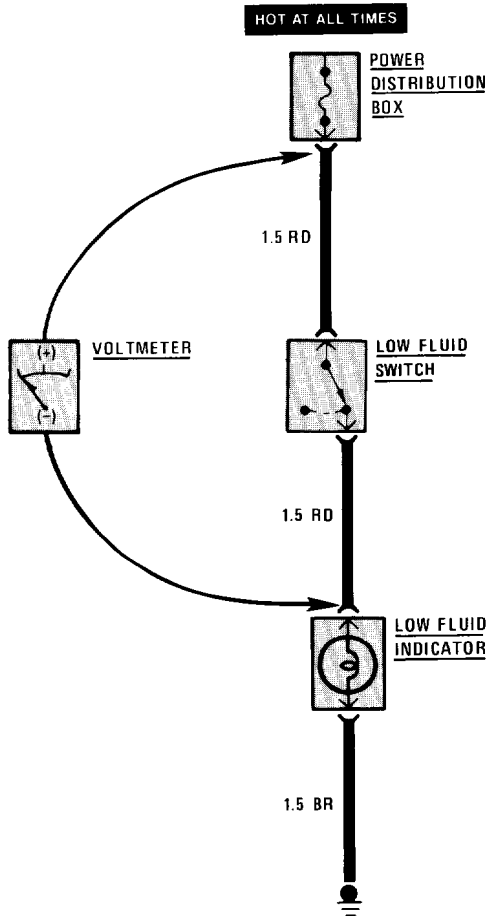

Voltage Drop Test

Continuity Test

To perform a continuity test, first disconnect the car battery. Then adjust the ohmmeter to read zero while holding the leads together. Connect the ohmmeter leads to connector or terminals at either end of the circuit's suspected problem area. The ohmmeter will show the resistance across that part of the circuit.

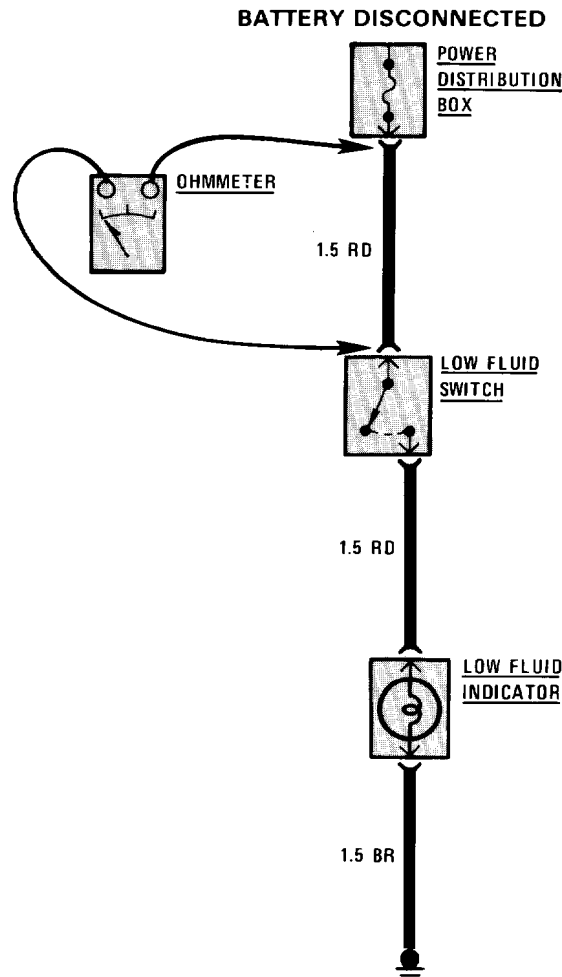

Continuity Test

Short Test Using Voltmeter

Remove the blown fuse and disconnect the load. Connect the voltmeter leads to the fuse terminals. The positive lead should be connected to the terminal closest to the power source.

Starting near the POWER DISTRIBUTION BOX, move the wire harness back and forth and watch the voltmeter reading. If the voltmeter registers a reading, there is a short to ground in the wiring. Somewhere in the area of the harness being moved, the wire insulation is worn away and the circuit is grounding.

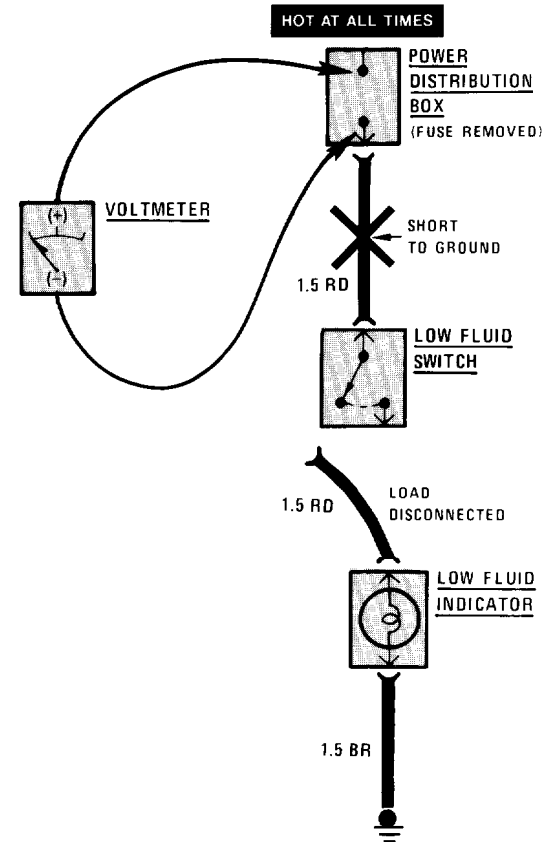

Short Test Using Voltmeter

8 SYSTEMATIC TROUBLESHOOTING

Short Test Using Ohmmeter

Disconnect the battery. Adjust the ohmmeter to read zero while holding the leads together. Remove the blown fuse and disconnect the load. Connect one lead of the ohmmeter to the fuse terminal that is closest to the load. Connect the other lead to a known good ground.

Starting near the POWER DISTRIBUTION BOX, move the wire harness back and forth and watch the ohmmeter reading. Low or no resistance indicates a short to ground. Infinitely high resistance indicates no short.

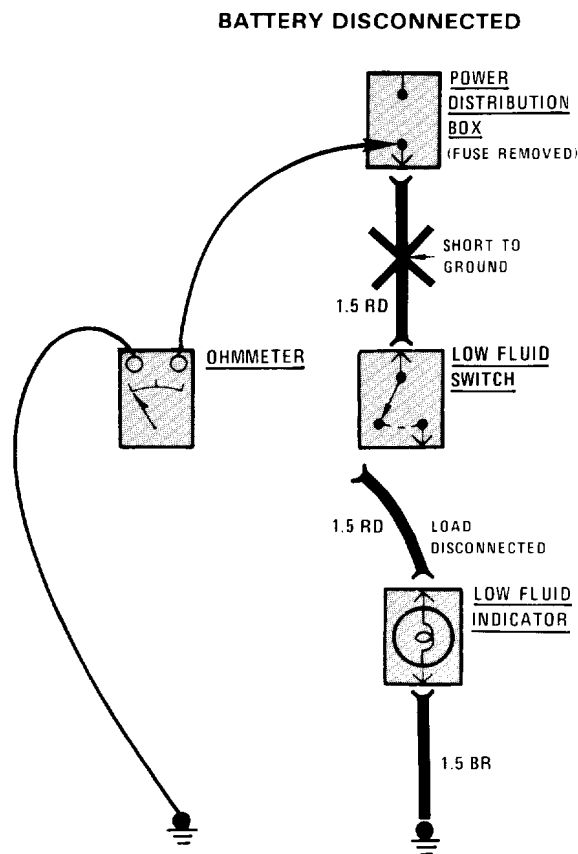

Short Test Using Ohmmeter

0670-0 POWER DISTRIBUTION

POWER DISTRIBUTION BOX

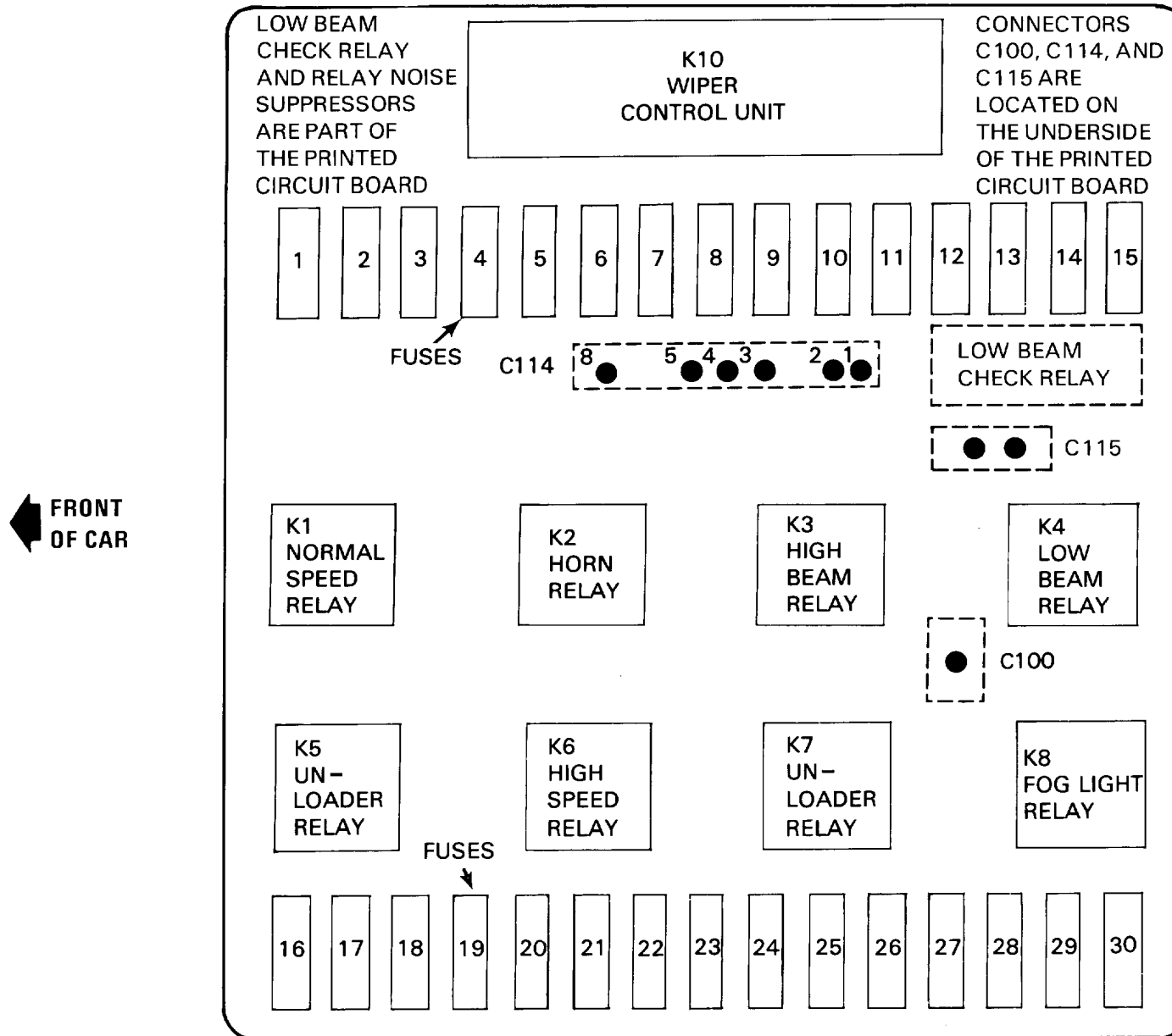

FUSE DATA CHART

FUSE NO.	SIZE/ COLOR	CIRCUIT NAME
1	7.5A	Headlights (also fuses 2, 13, 14).
2	7.5A	Headlights (also fuses 1, 13, 14).
3	15A	Auxiliary Fan (also fuses 18, 19, 20).
4	15A	Lights: Turn/Hazard (also fuse 24); Active Check Control (also fuses 6, 10, 21, 22, 23).
5	30A	Wiper/Washer.
6	7.5A	Stop Lights; Map Reading Light; Cruise Control; Active Check Control (also fuses 4, 10, 21, 22, 23); Glove Box Light; Antilock Braking System (also fuse 10).
7	15A	Horn.
8	30A	Rear Defogger (also fuse 23).
9	15A	Injection Electronics (also fuses 11, 21).
10	7.5A	Seatbelt Warning (also fuse 21); Service Interval Indicator (also fuse 21); Antilock Braking System (also fuse 6); Tachometer/Fuel Economy Gauges (also fuse 21); Gauges/Indicators; Brake Warning System; Back Up Lights; On-Board Computer (also fuses 12, 21, 27); Start; Active Check Control (also fuses 4, 6, 21, 22, 23).
11	7.5A	Injection Electronics (also fuses 9, 21).
12	7.5A	Radio/Antenna (also fuses 21, 27, 28); Speedometer/Indicators; On-Board Computer (also fuses 10, 21, 27).
13	7.5A	Headlights (also fuses 1, 2, 14).
14	7.5A	Headlights (also fuses 1, 2, 13).
15	7.5A	Not Used.
16	15A	Heated Seats.
17	30A	Sunroof; Power Windows.
18	30A	Auxiliary Fan (also fuses 3, 19, 20).
19	7.5A	Auxiliary Fan (also fuses 3, 18, 20); Interior Lights (also fuses 21, 27); Power Mirrors.

FUSE NO.	SIZE/ COLOR	CIRCUIT NAME
20	30A	Heater/Air Conditioning; Auxiliary Fan (also fuses 3, 18, 19).
21	7.5A	Auto-Charging Flashlight; Ignition Key Warning/Seatbelt Warning; (also fuse 10); Injection Electronics (also fuses 10, 11); Interior Lights (also fuses 19, 27); Radio/Antenna (also fuses 12, 27, 28); Trunk Light; Active Check Control (also fuses 4, 6, 10, 22, 23); Service Interval Indicator (also fuse 10); On-Board Computer (also fuses 10, 12, 27); Tachometer/Fuel Economy Gauge (also fuse 10).
22	7.5A	Active Check Control (also fuses 4, 6, 10, 21, 23); Lights: Front Park/Tail (also fuse 23); Lights: Front Side Marker (also fuse 23).
23	7.5A	Lights: Dash Lights: Front Park/Tail (also fuse 22); Lights: Front Side Marker (also fuse 22); Lights: Rear Marker/License; Active Check Control (also fuses 4, 6, 10, 21, 22); Rear Defogger (also fuse 8).
24	15A	Lights: Turn/Hazard (also fuse 4).
25	—	Not Used.
26	15A	Not Used.
27	30A	Interior Lights (also fuses 19, 21); Central Locking; Radio/Antenna (also fuses 12, 21, 28); On-Board Computer (also fuses 10, 12, 21).
28	30A	Cigar Lighter; Radio/Antenna (also fuses 12, 21, 27).
29	7.5A	Fog Lights (also fuse 30).
30	7.5A	Fog Lights (also fuse 29).
POWER WINDOW CIRCUIT BREAKER		25A Power Windows

0670-4 POWER DISTRIBUTION

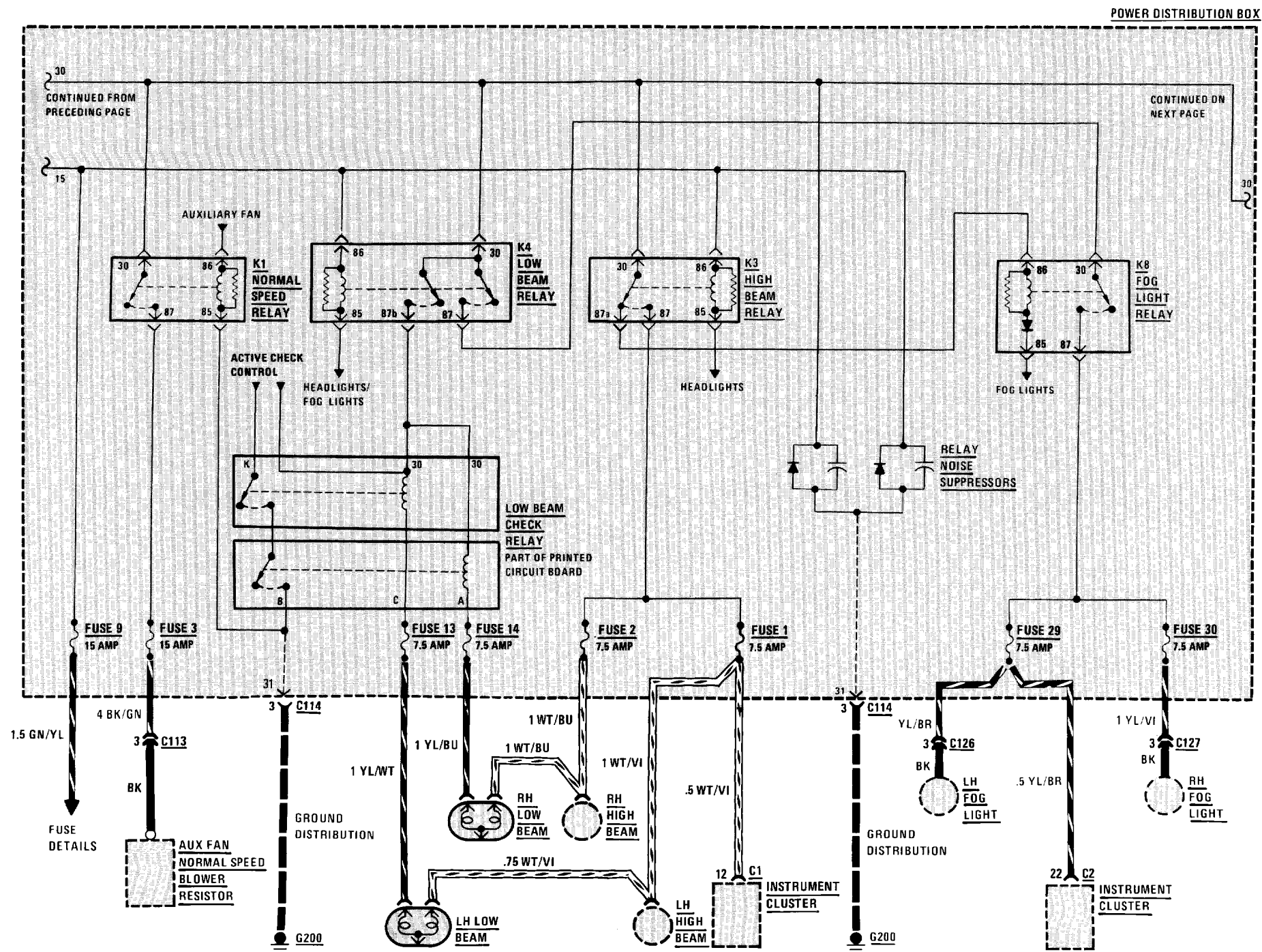

POWER DISTRIBUTION BOX

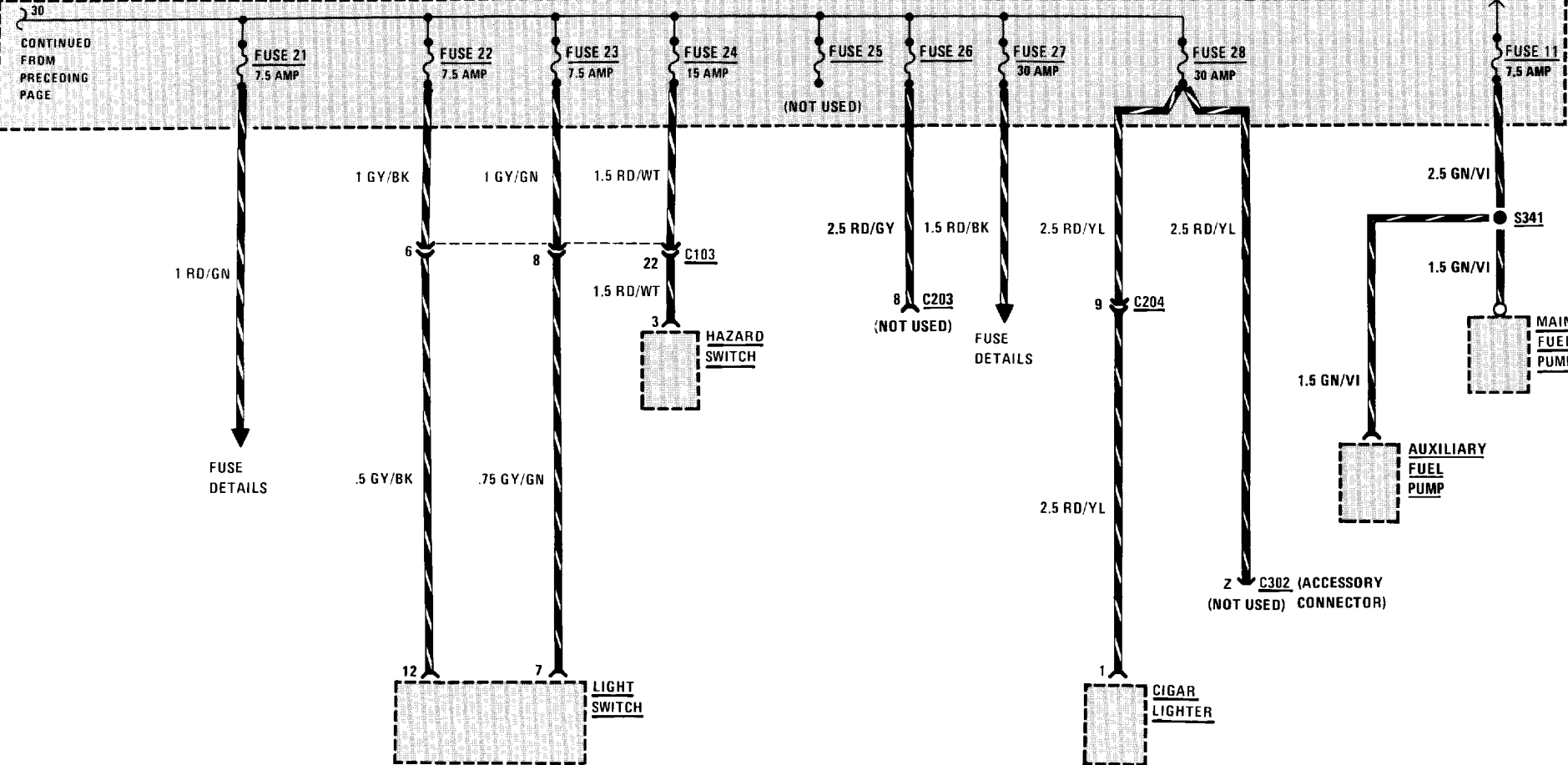

0670-6 POWER DISTRIBUTION

FUSE DETAILS: FUSES 4, 5, AND 6

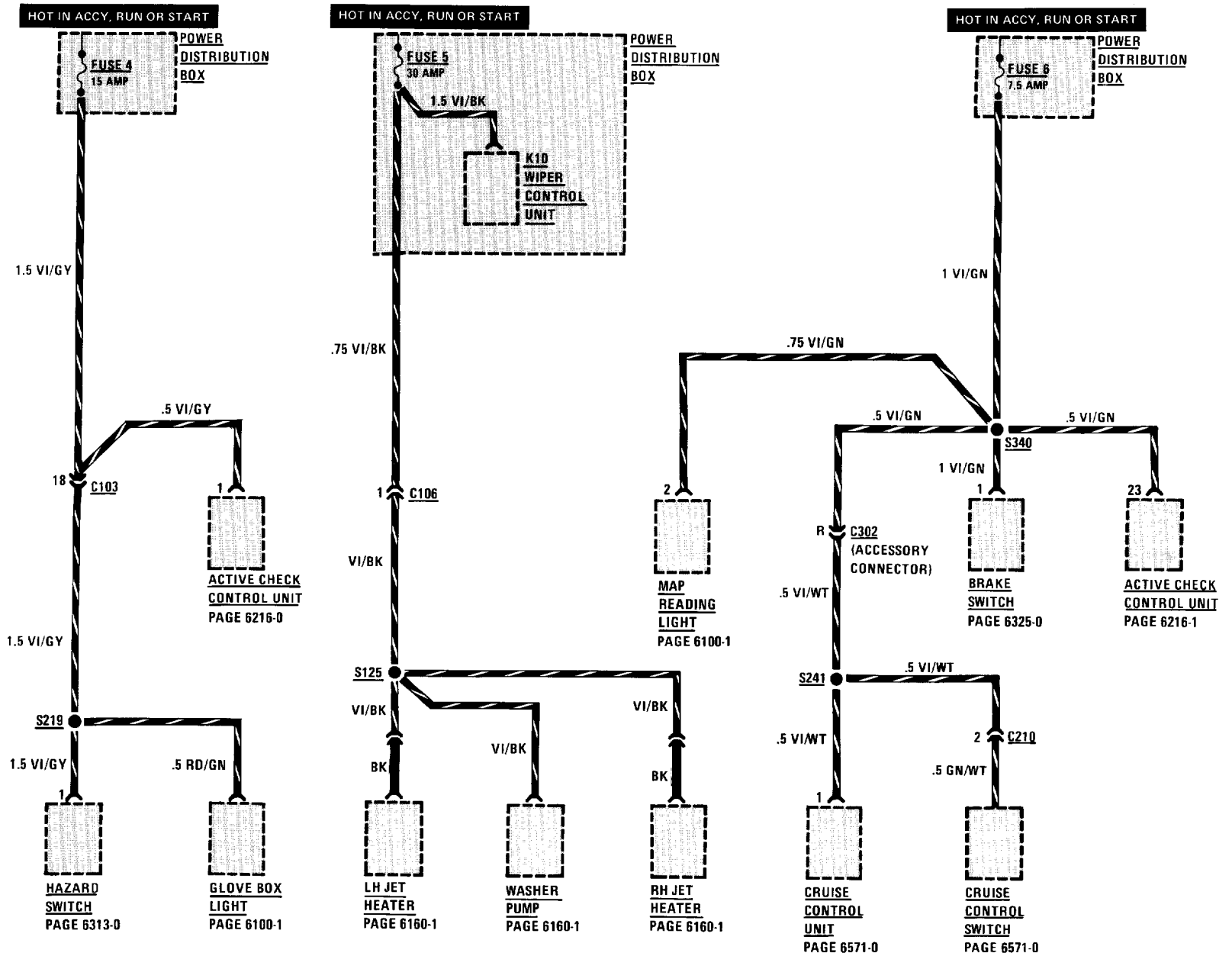

FUSE DETAILS: FUSES 8, 12 AND 19

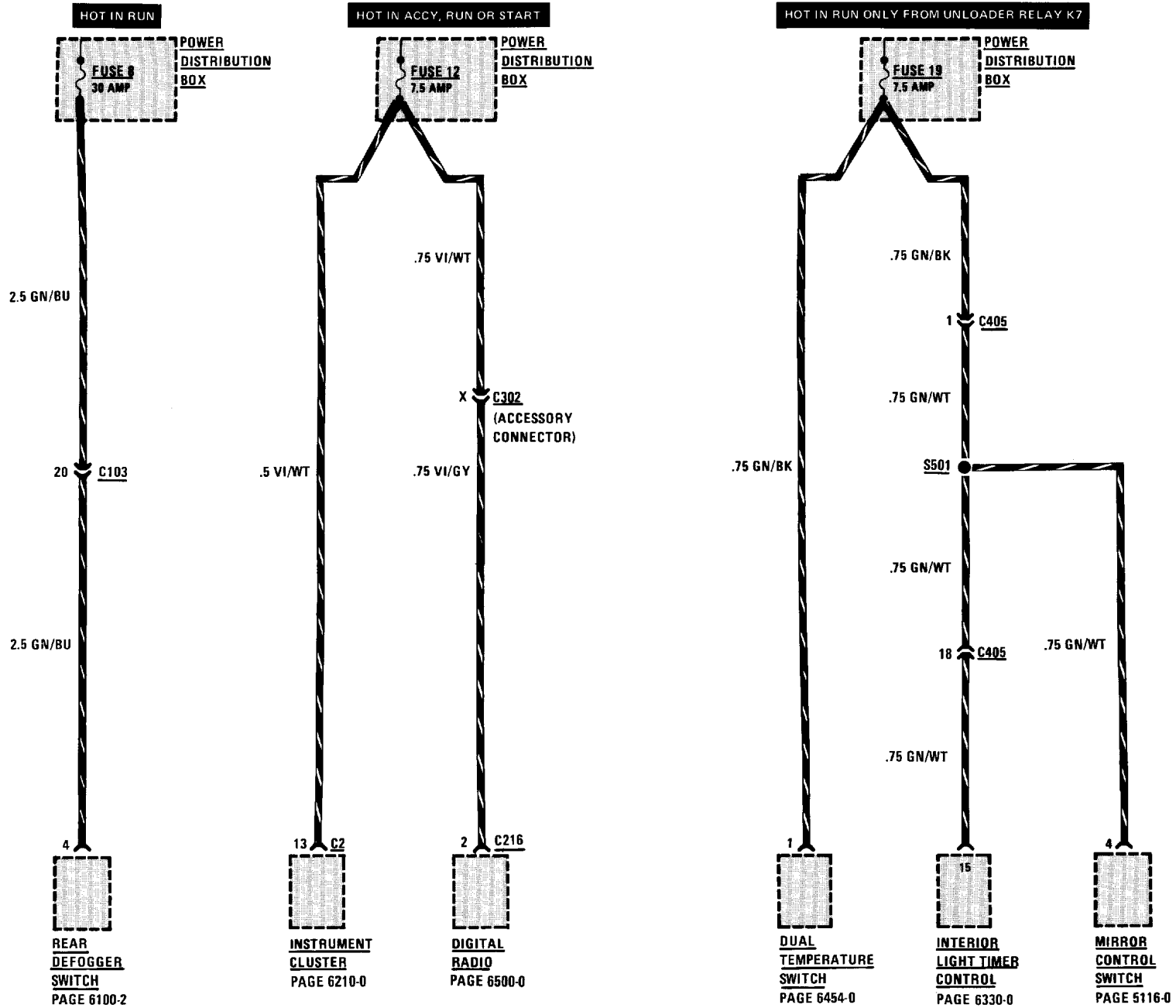

FUSE DETAILS: FUSE 10

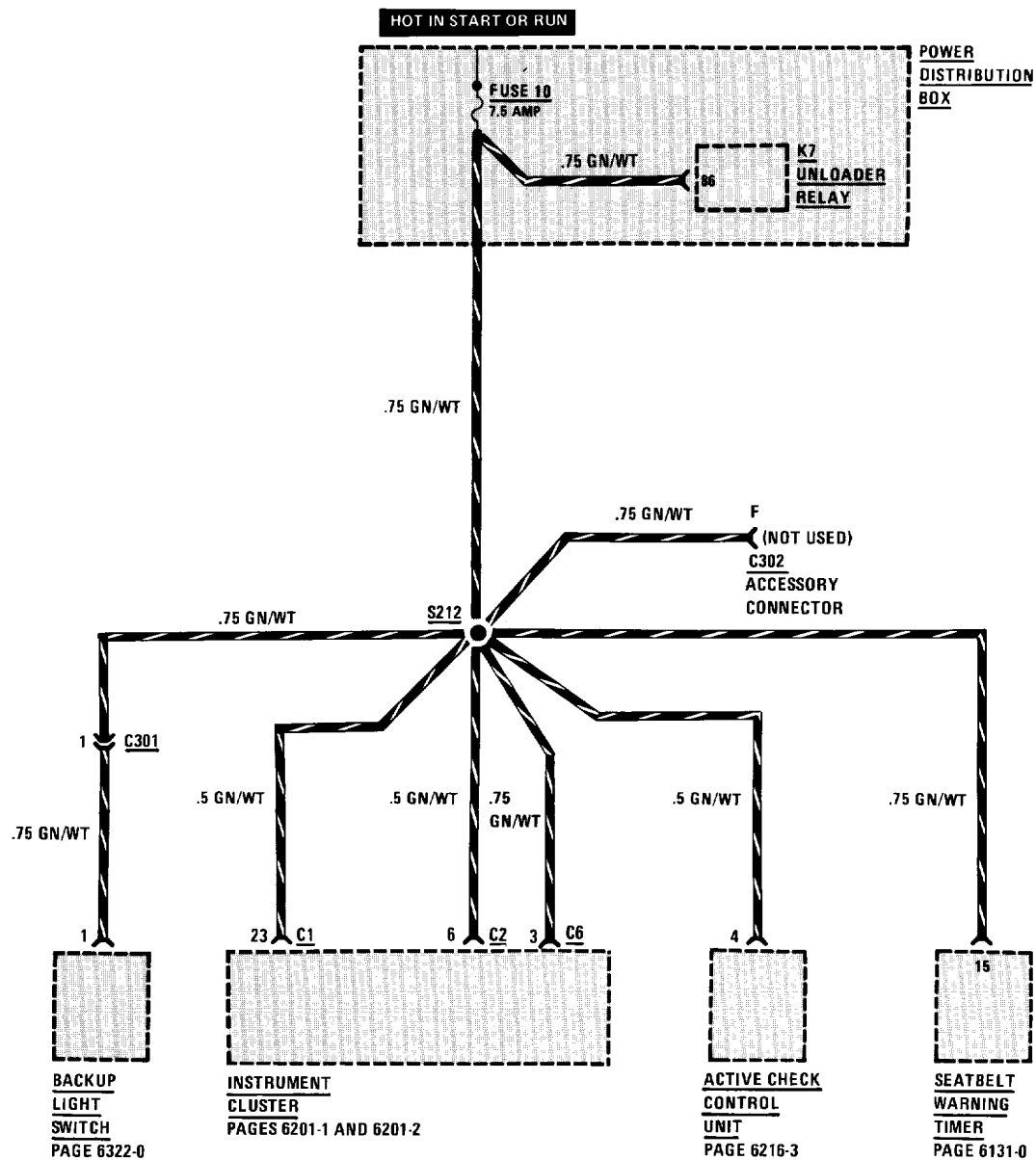

FUSE DETAILS: FUSE 20

HOT IN RUN ONLY FROM UNLOADER RELAY K7

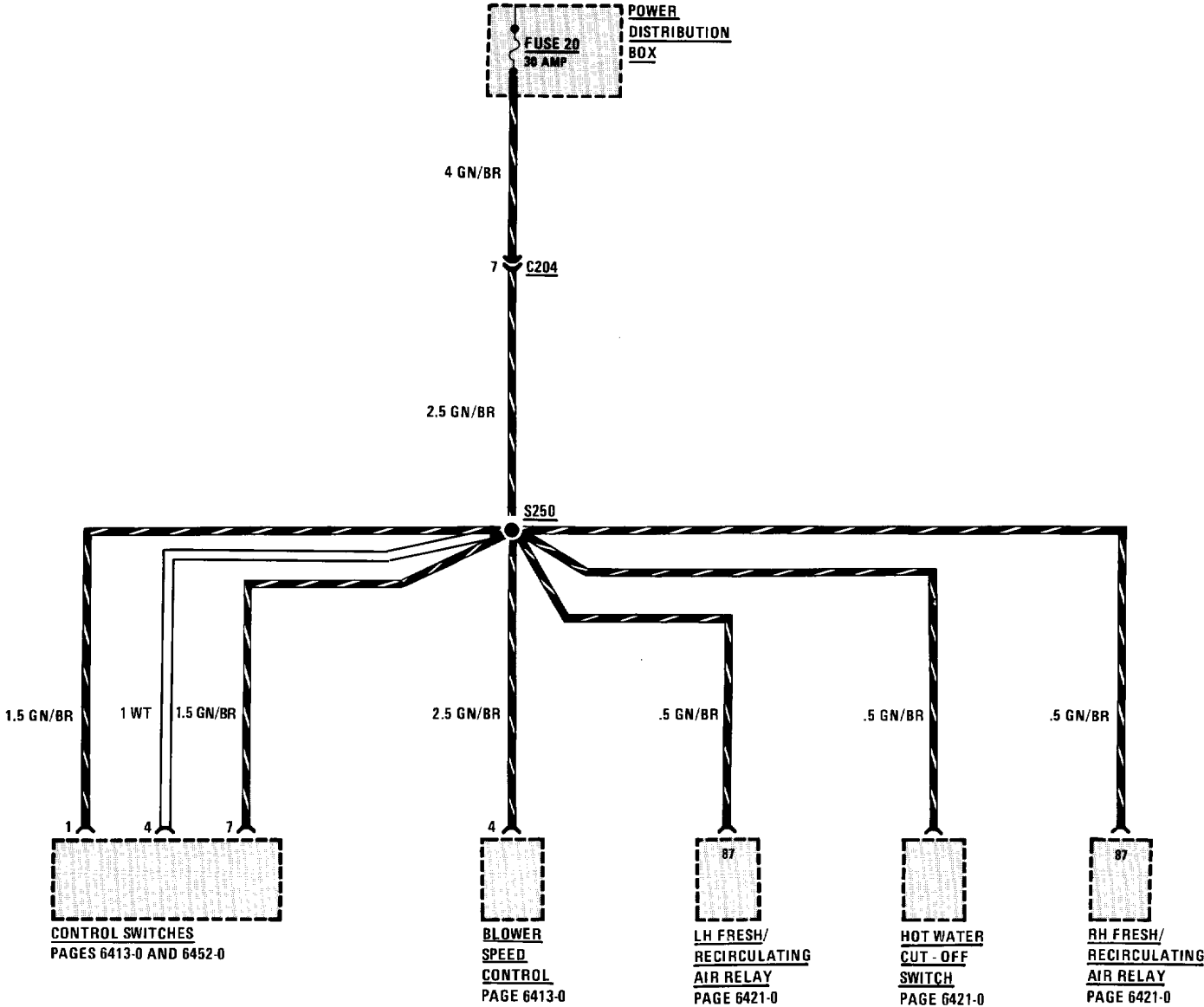

FUSE DETAILS: FUSES 27 AND 9

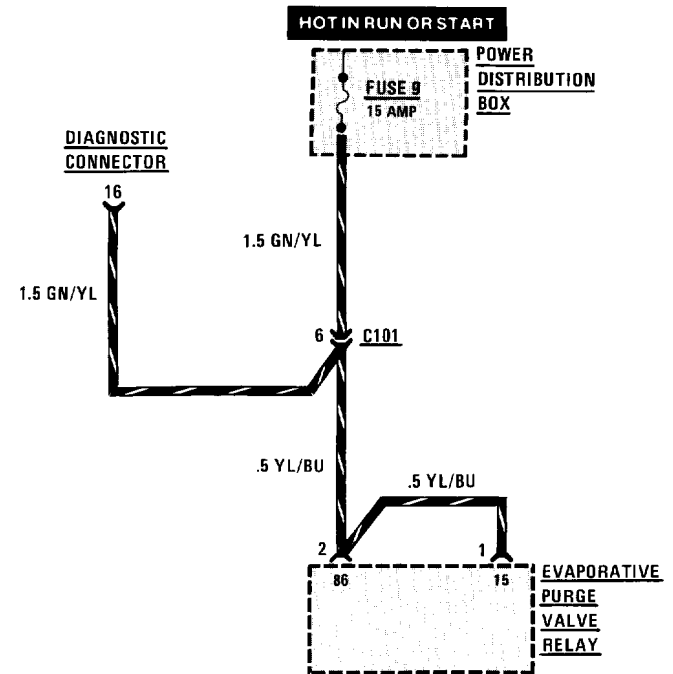
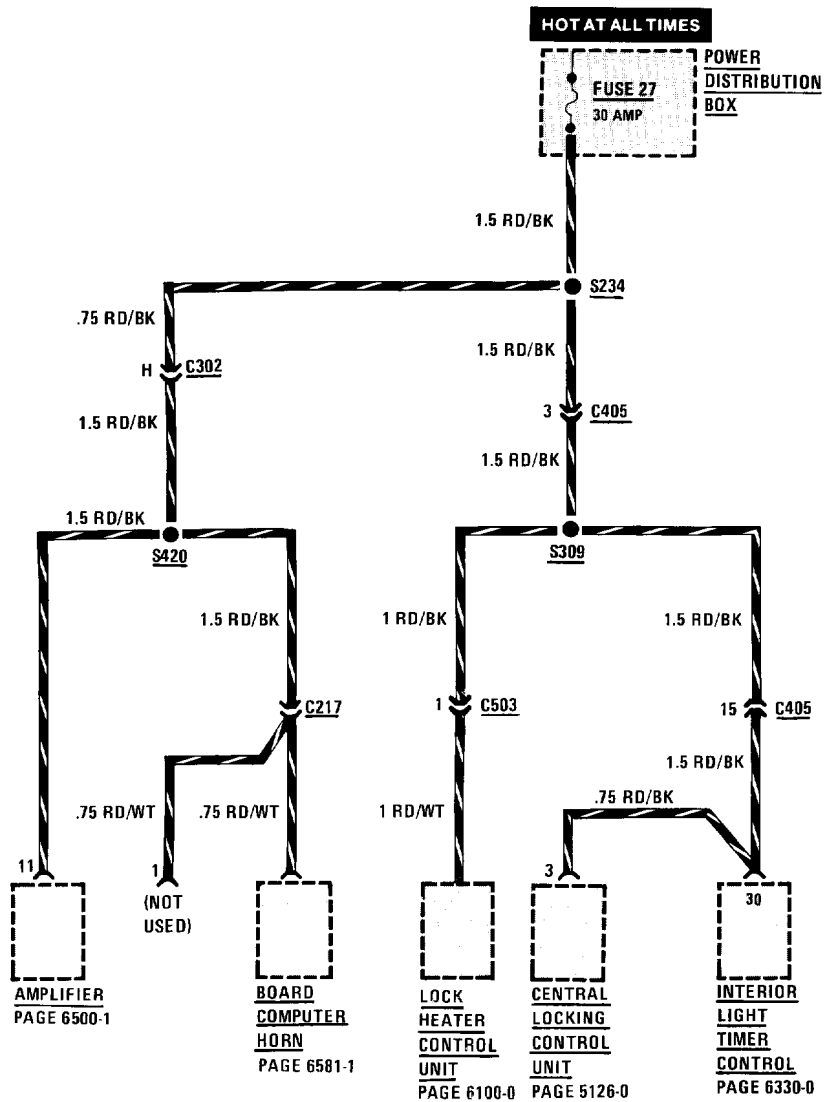

GROUND DISTRIBUTION (G103)

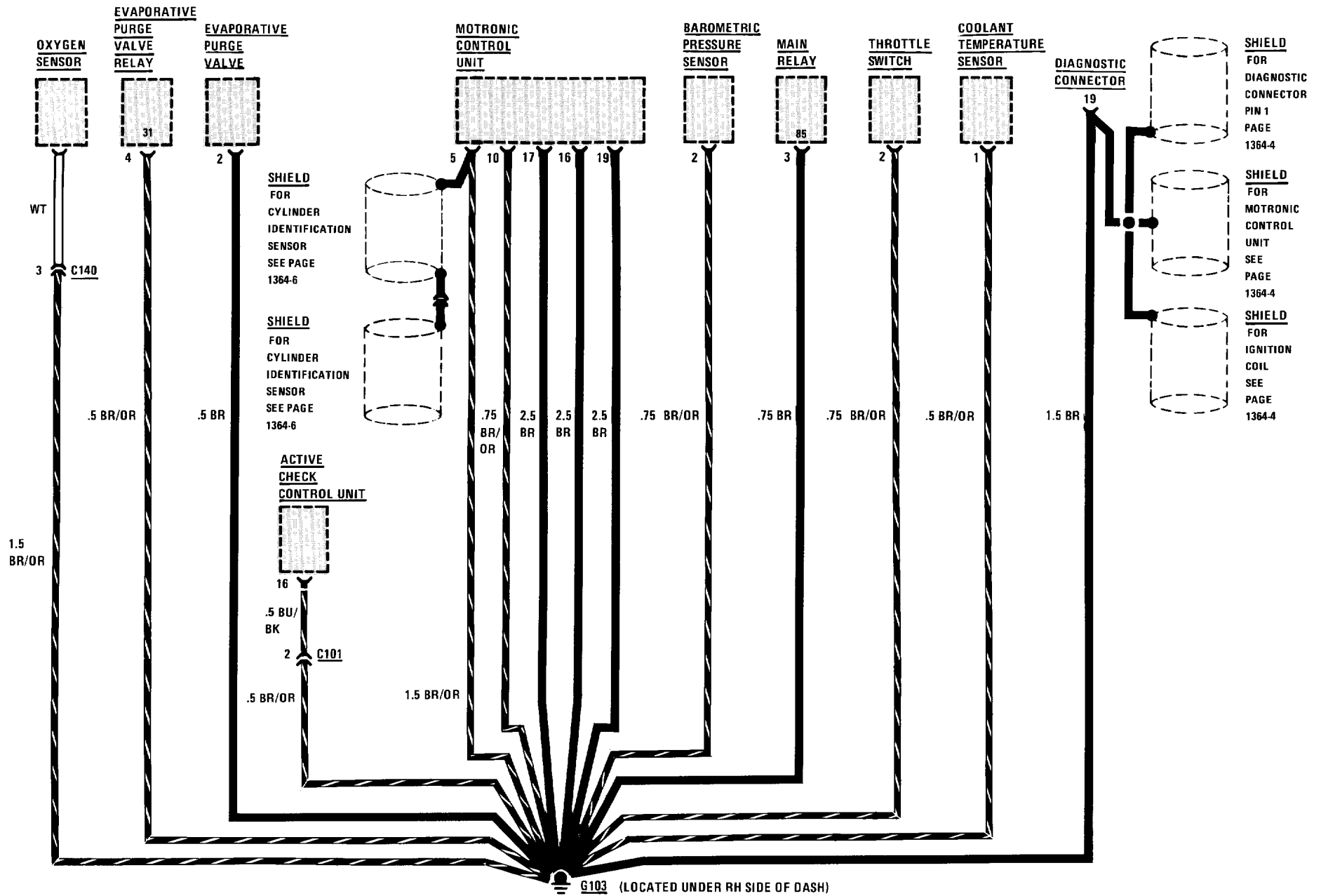

GROUND DISTRIBUTION G104 AND G200 (PARTIAL)

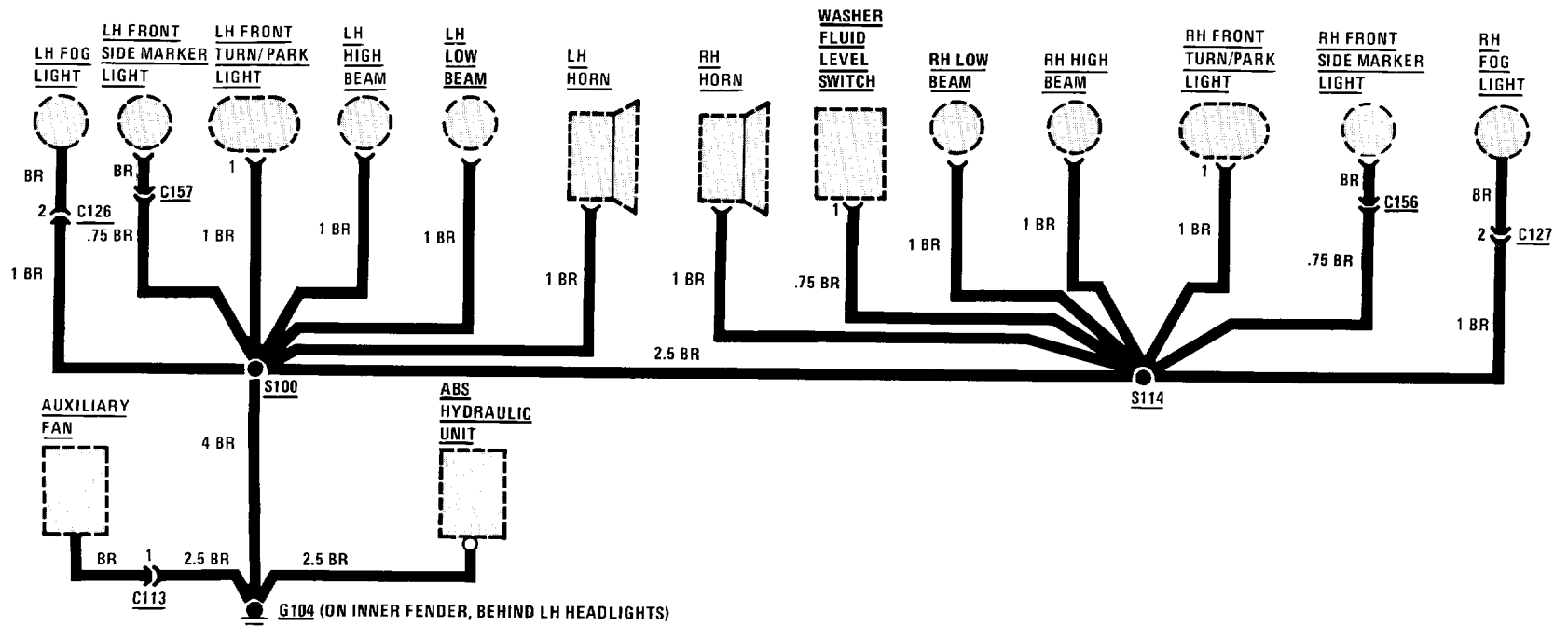
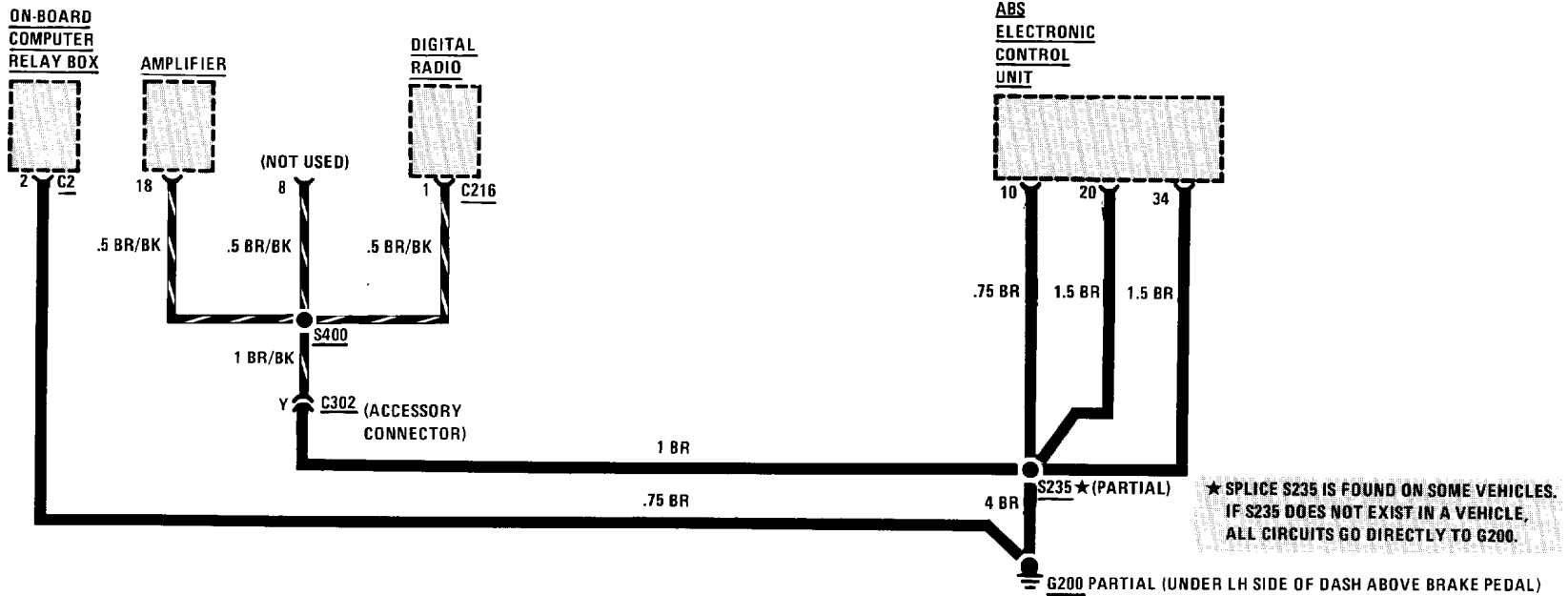

GROUND DISTRIBUTION: G200 (PARTIAL) AND G201

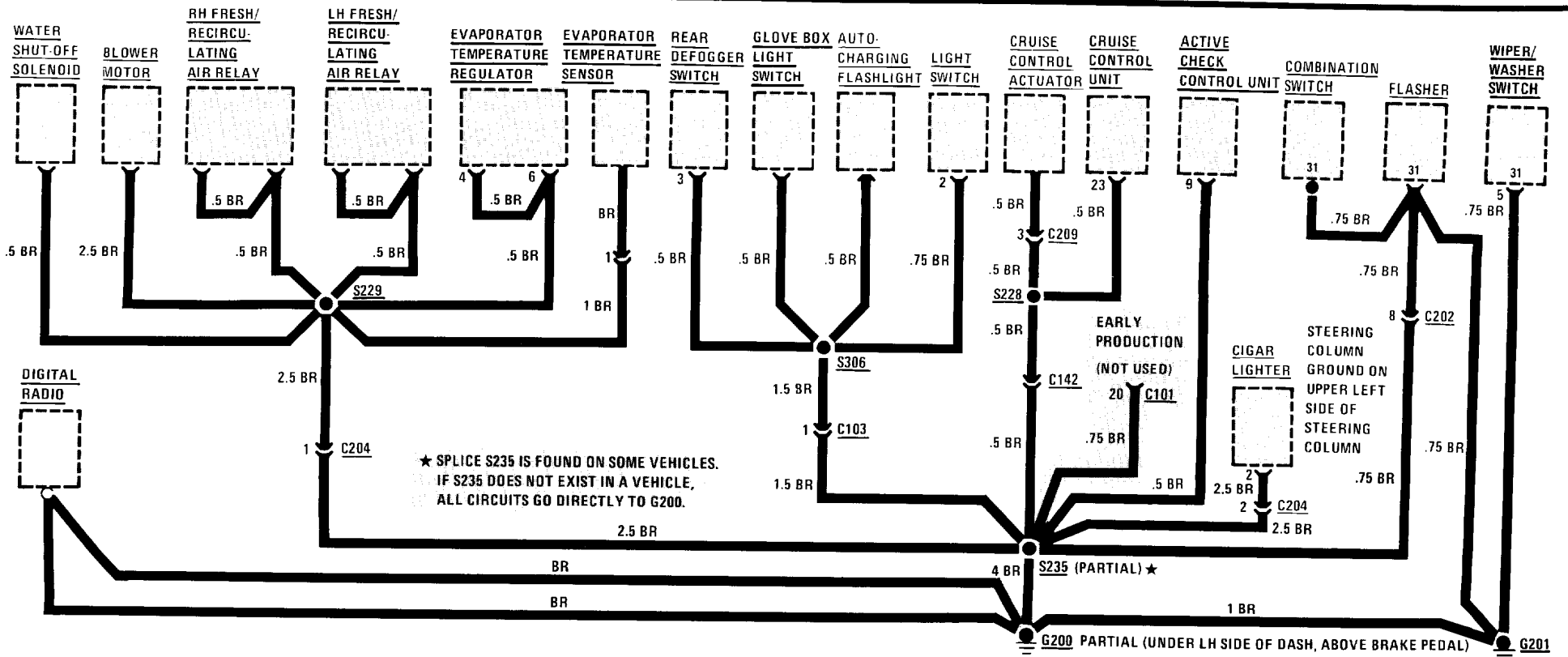
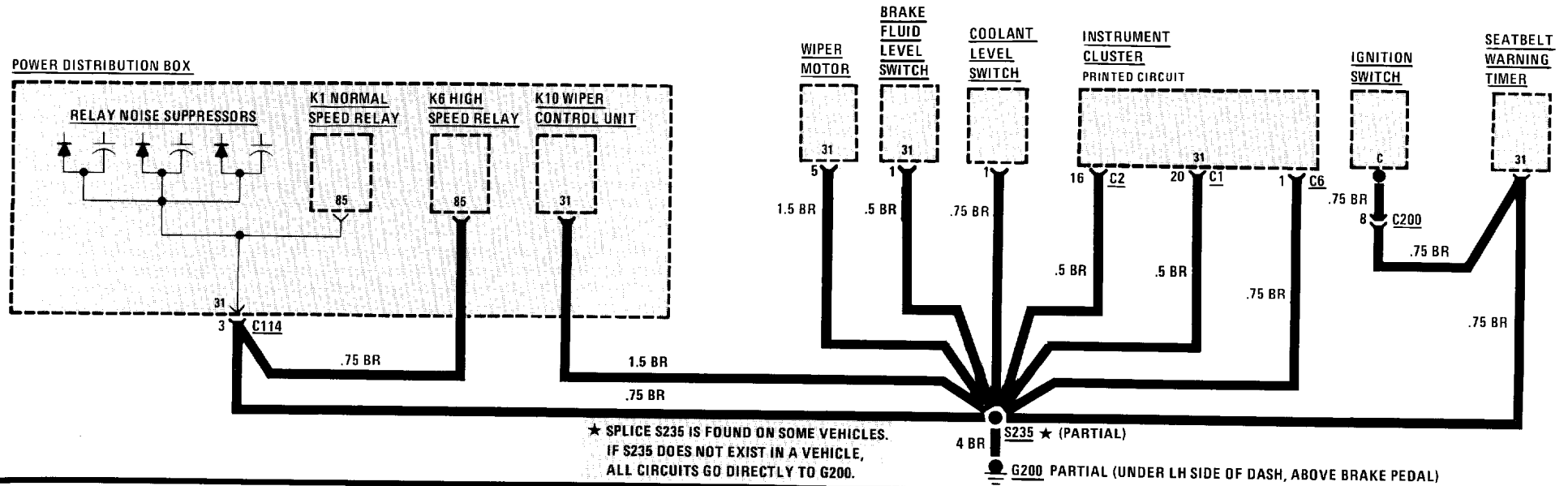

GROUND DISTRIBUTION: G200 (PARTIAL) AND G202

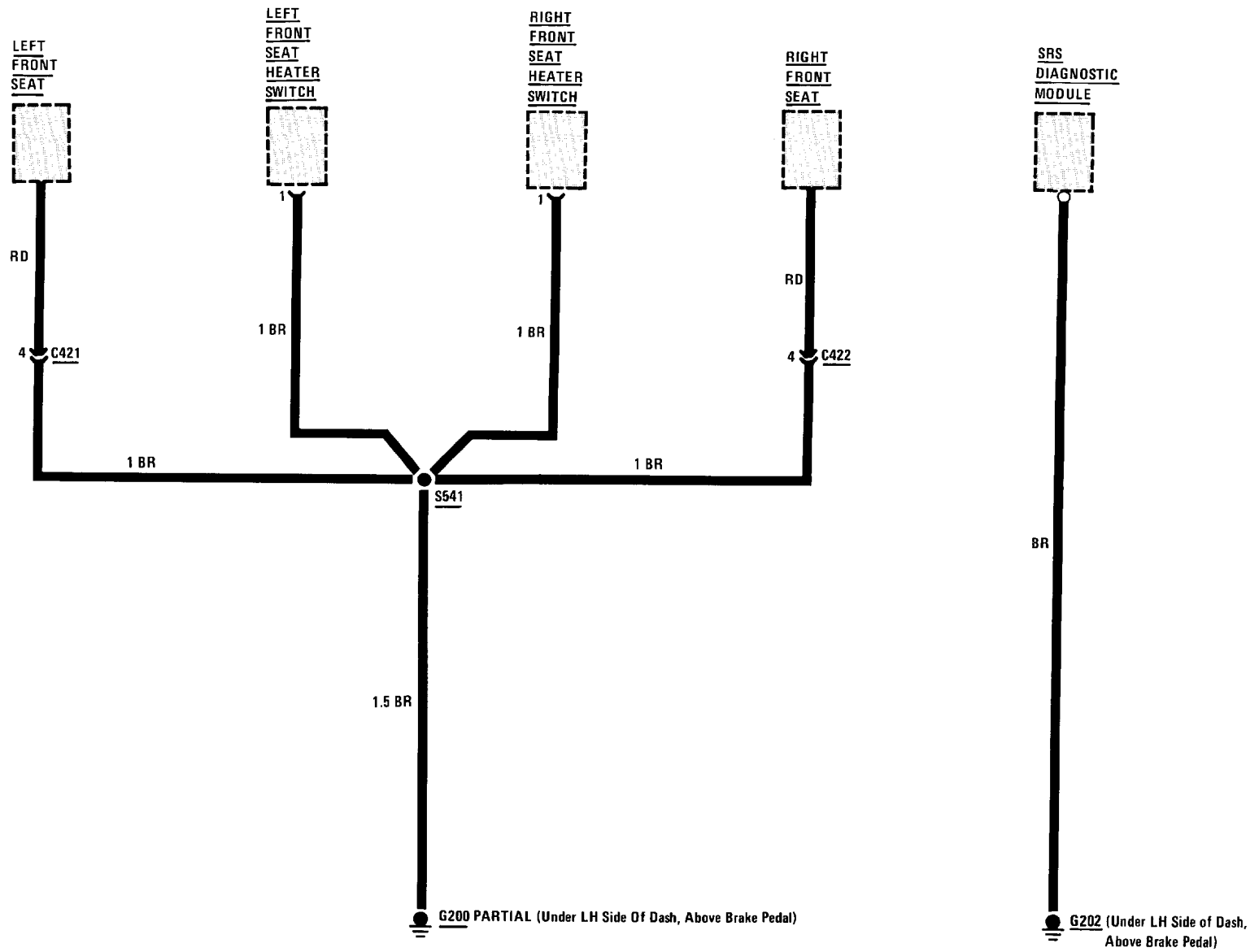

0670-16 POWER DISTRIBUTION

GROUND DISTRIBUTION: G200 (PARTIAL) AND G300

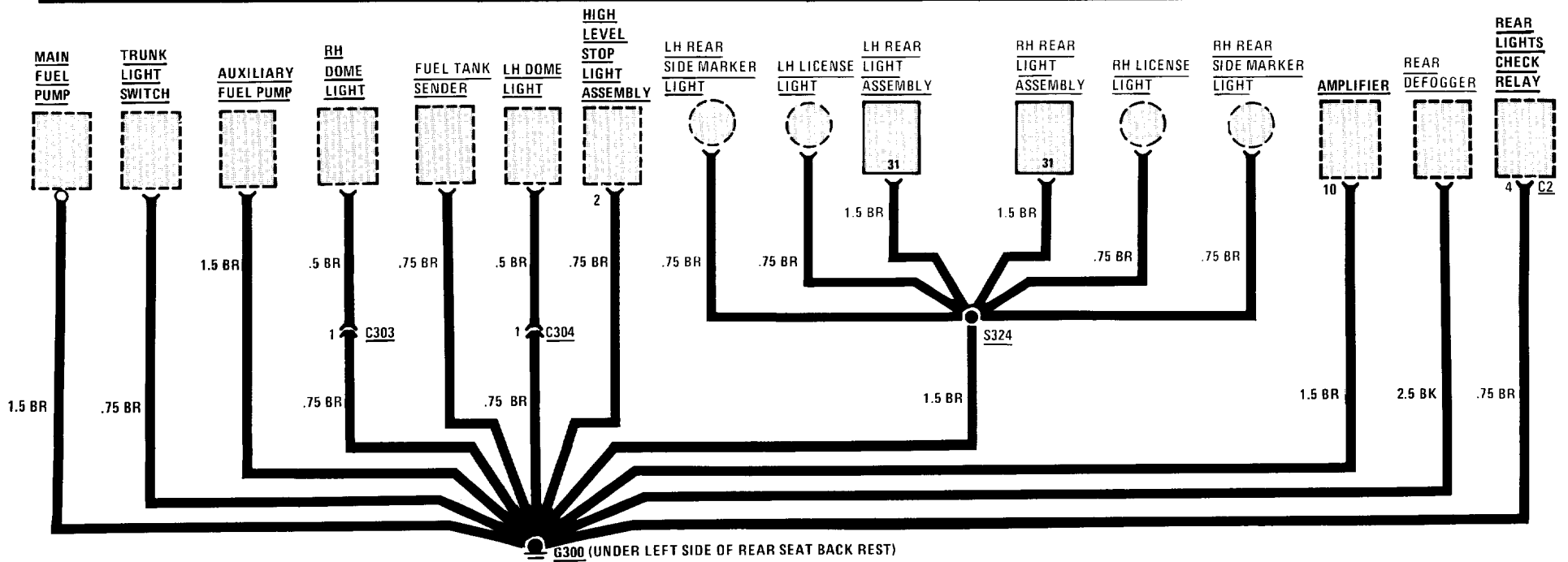
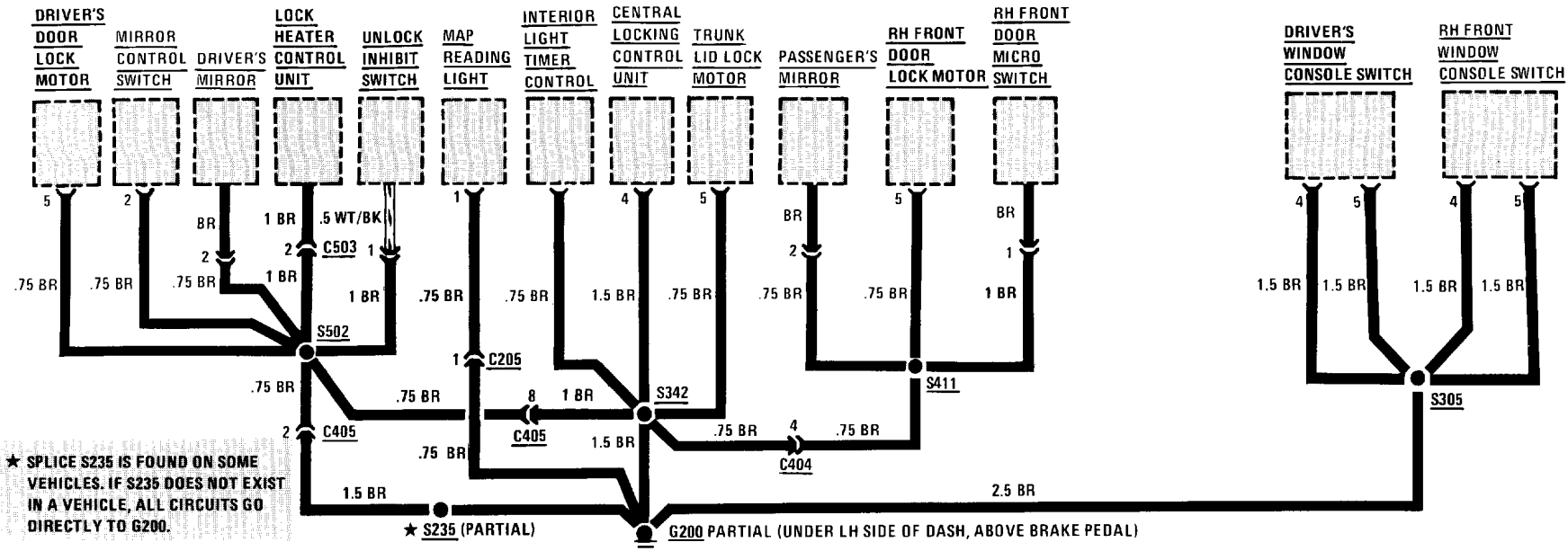

1240-0 START

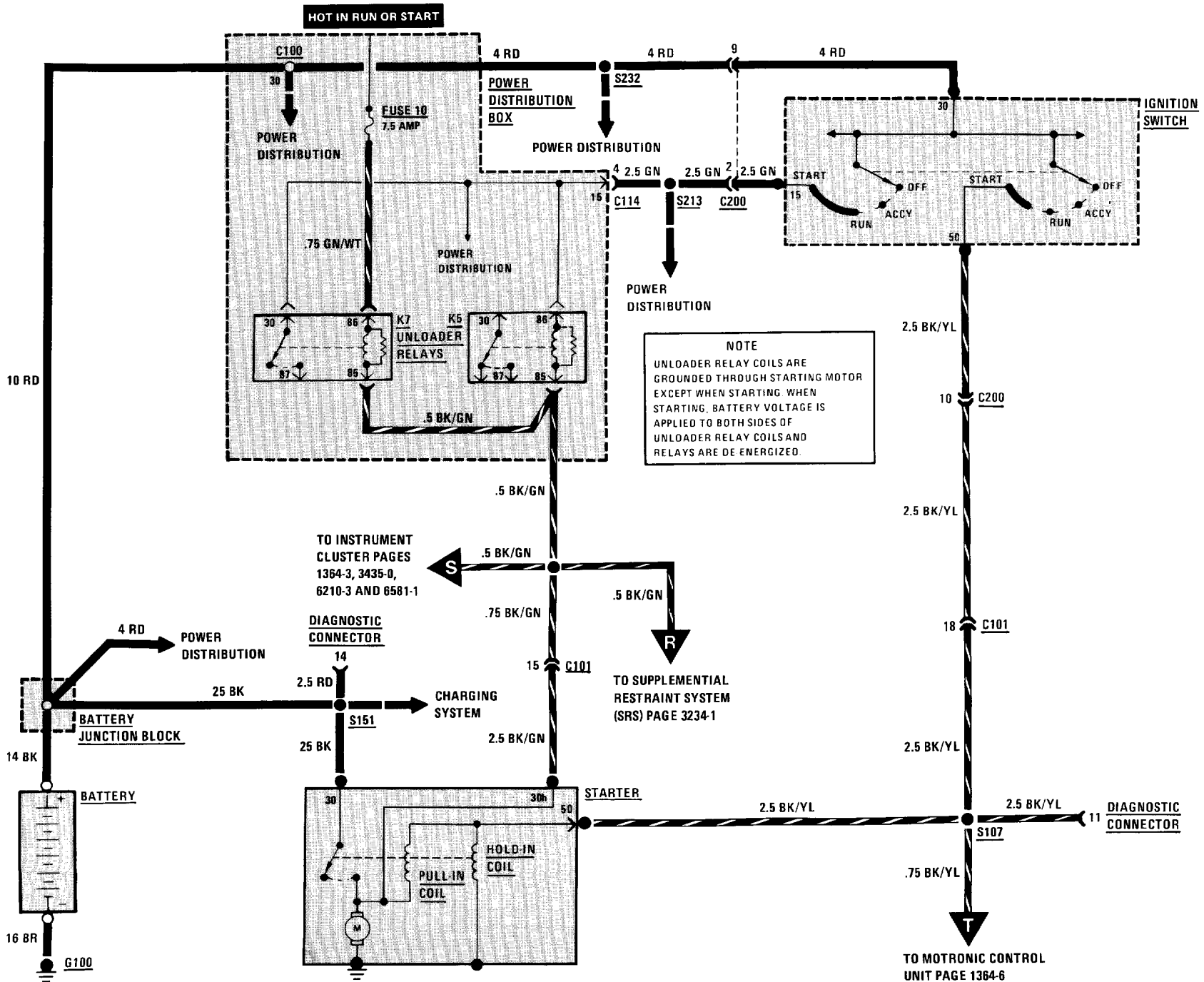

ENGINE BLOCK DIAGRAM

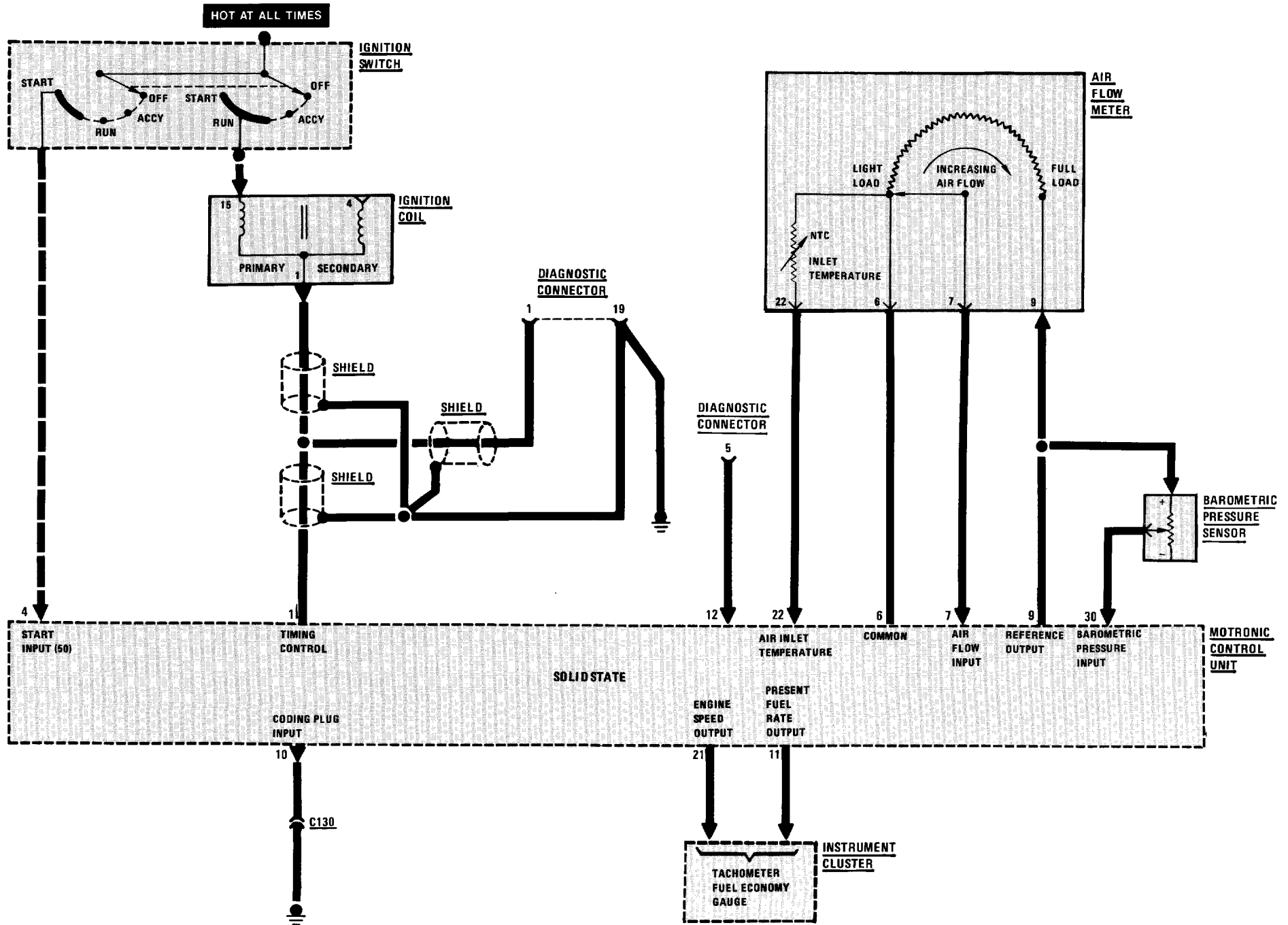

ENGINE BLOCK DIAGRAM

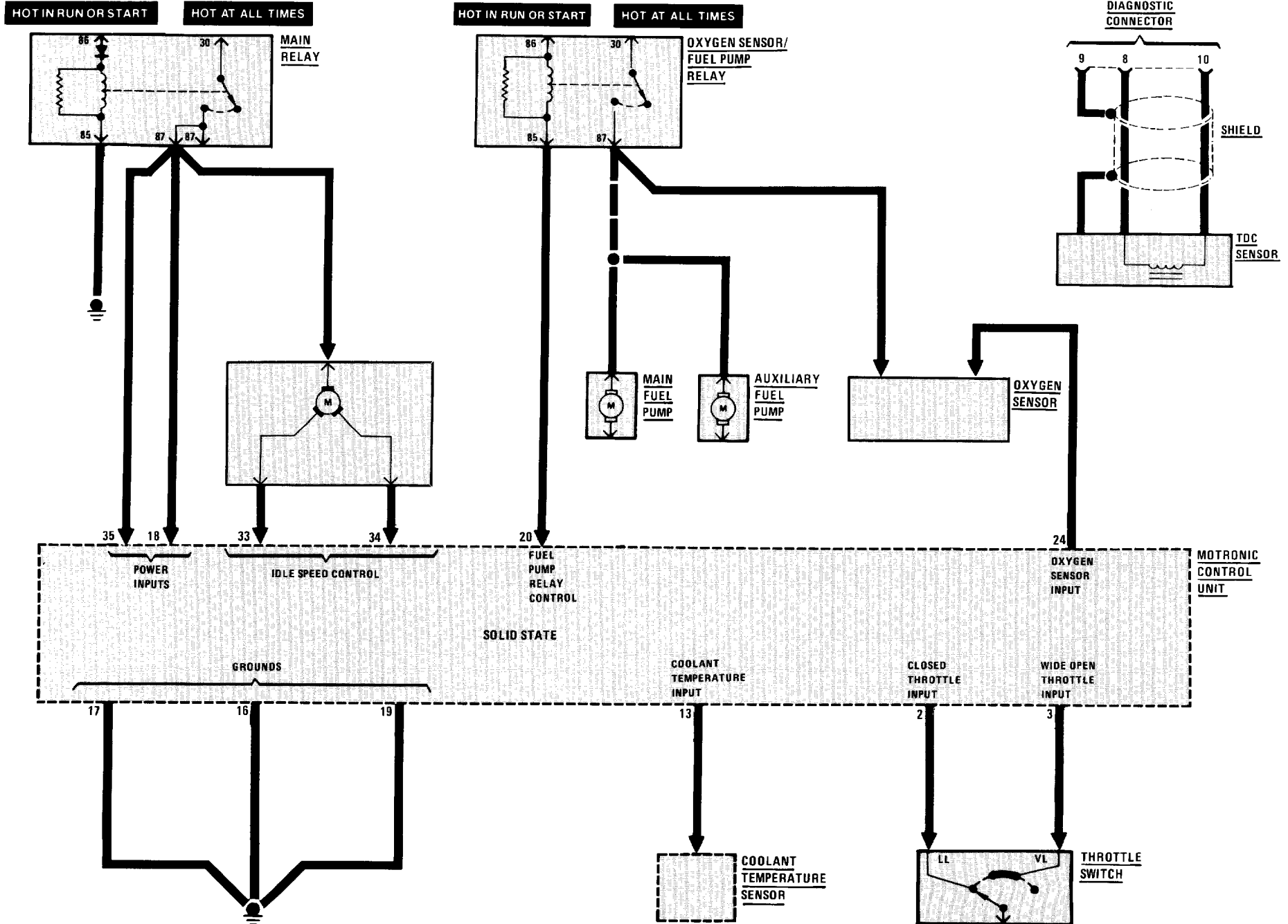

ENGINE BLOCK DIAGRAM

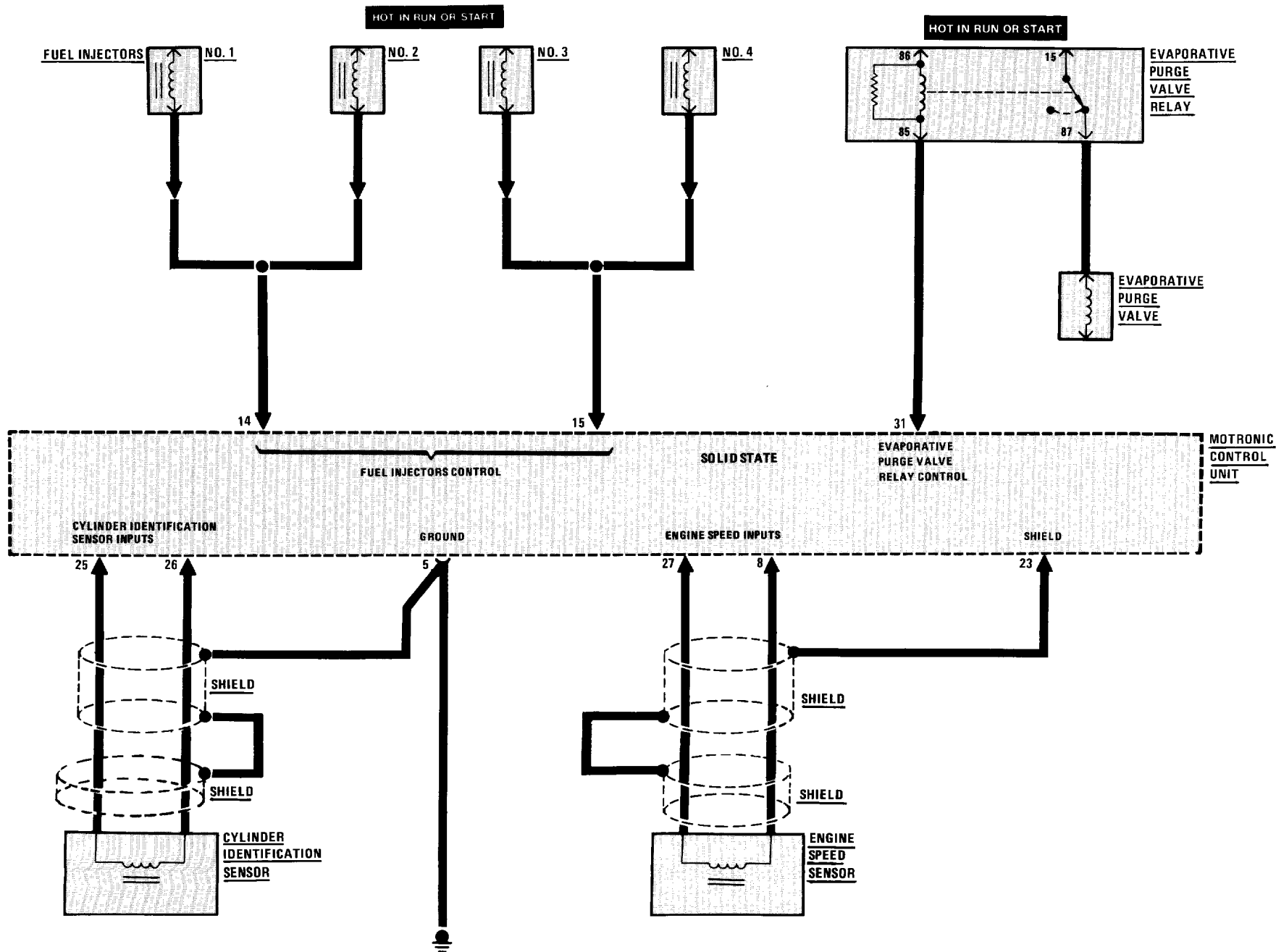

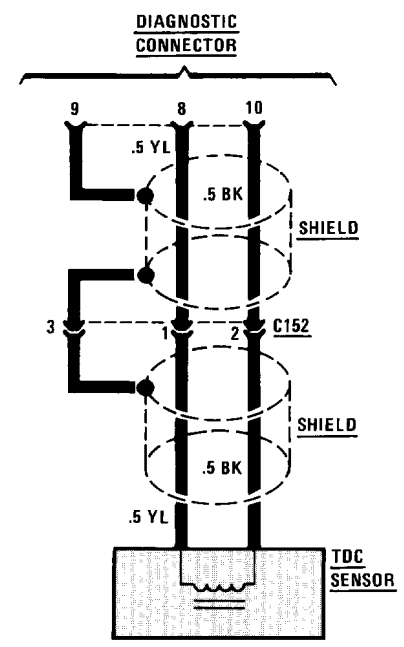
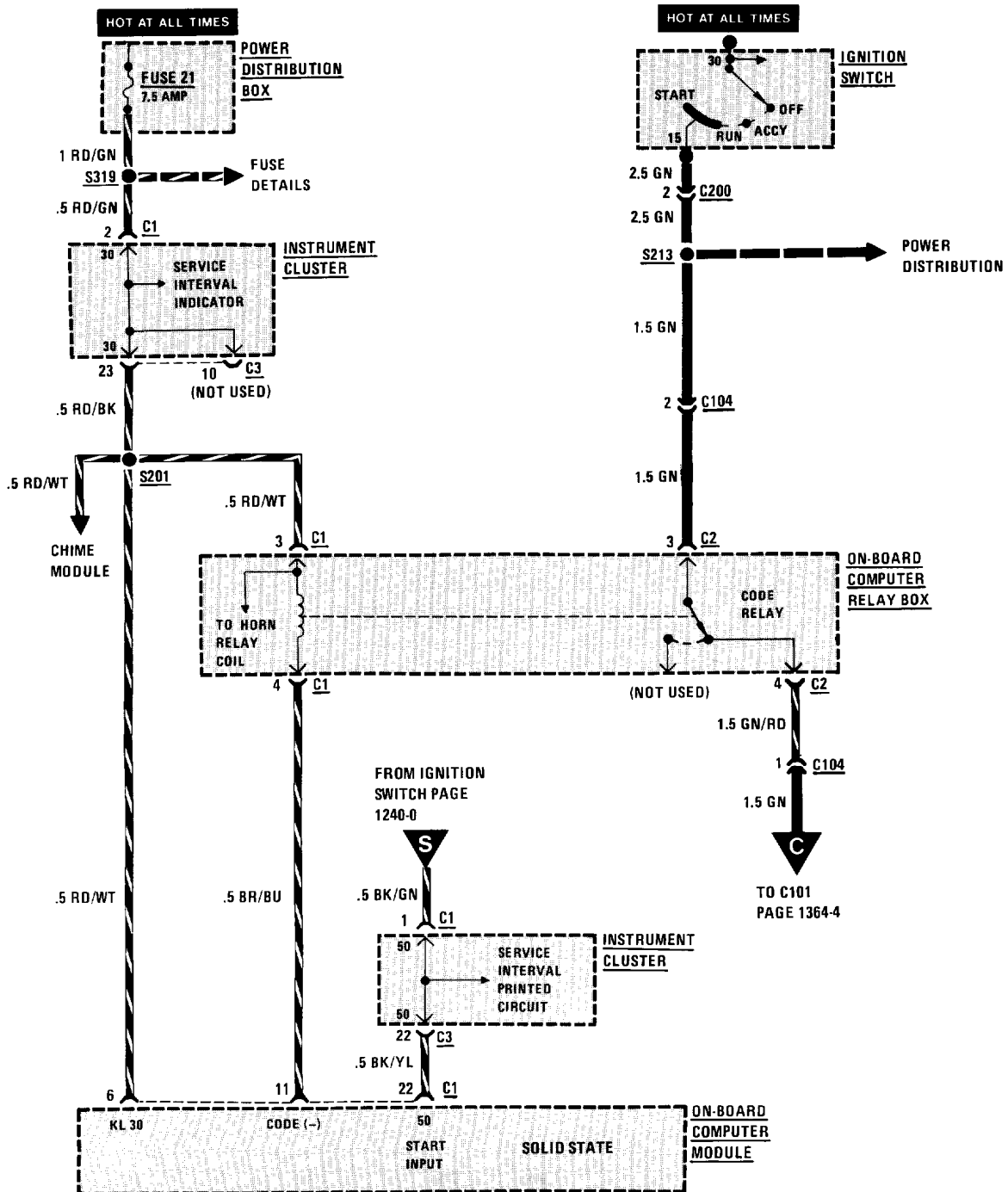

1364-4 INJECTION ELECTRONICS S14 ENGINE

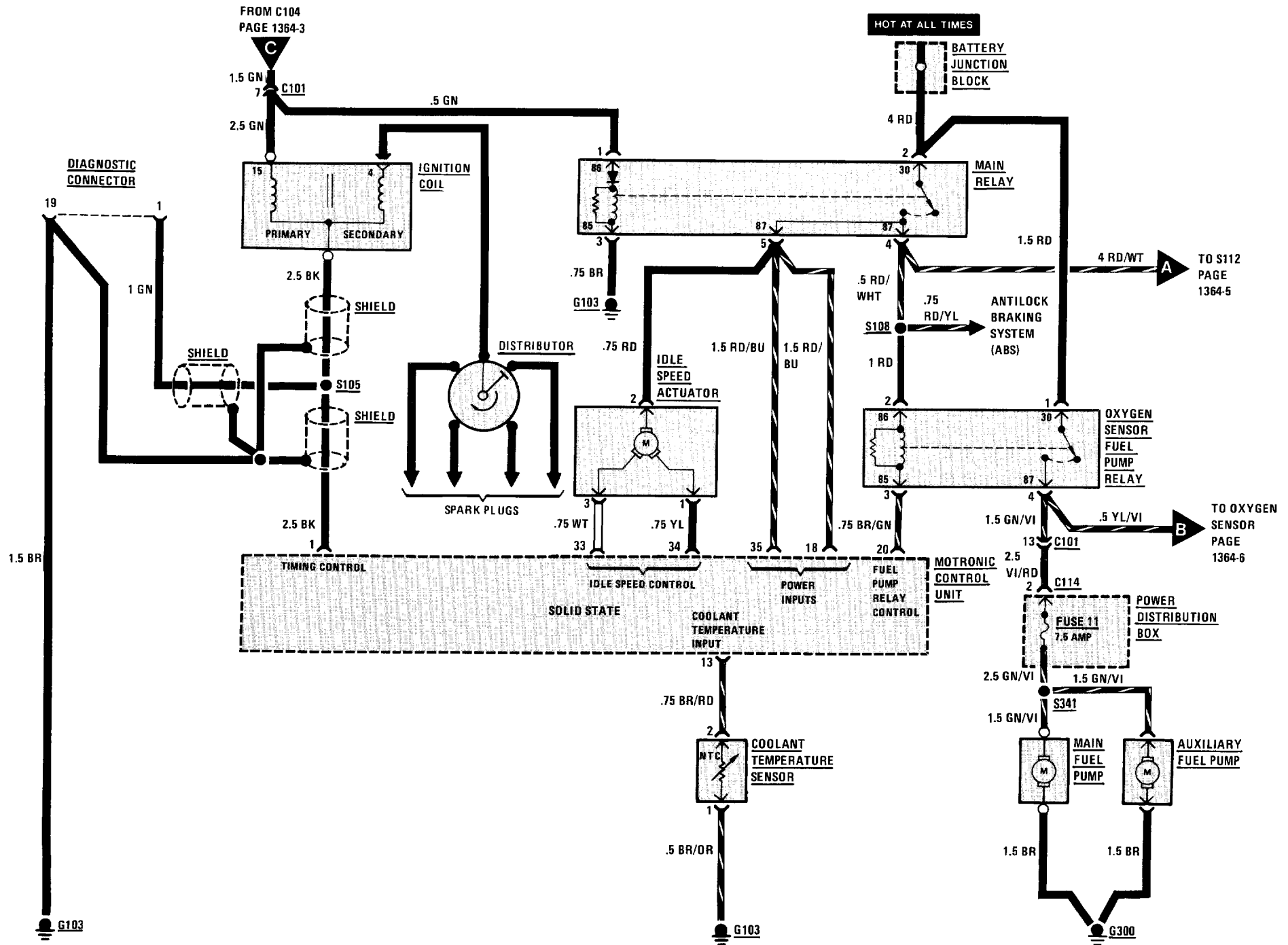

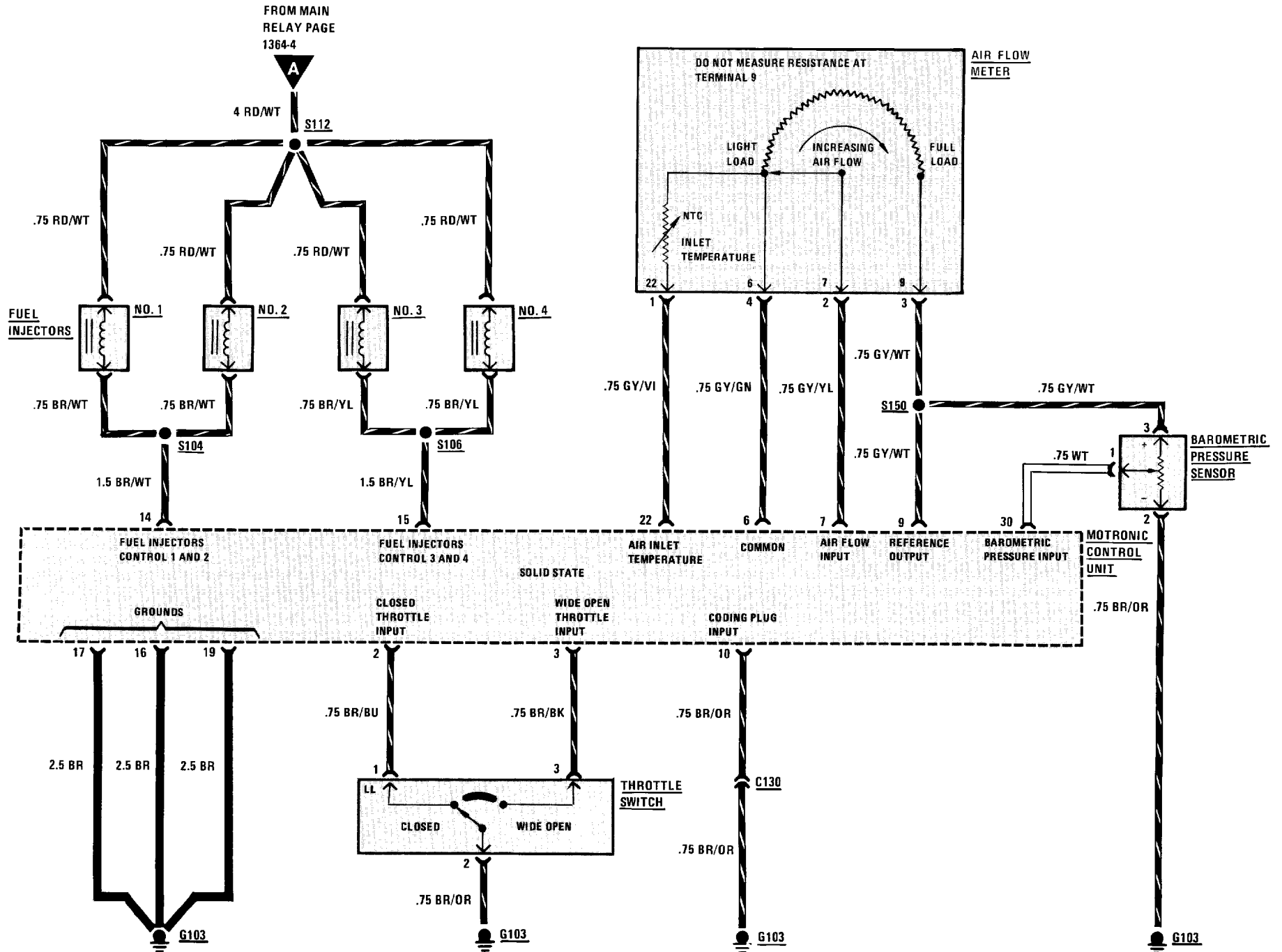

1364-6 INJECTION ELECTRONICS S14 ENGINE

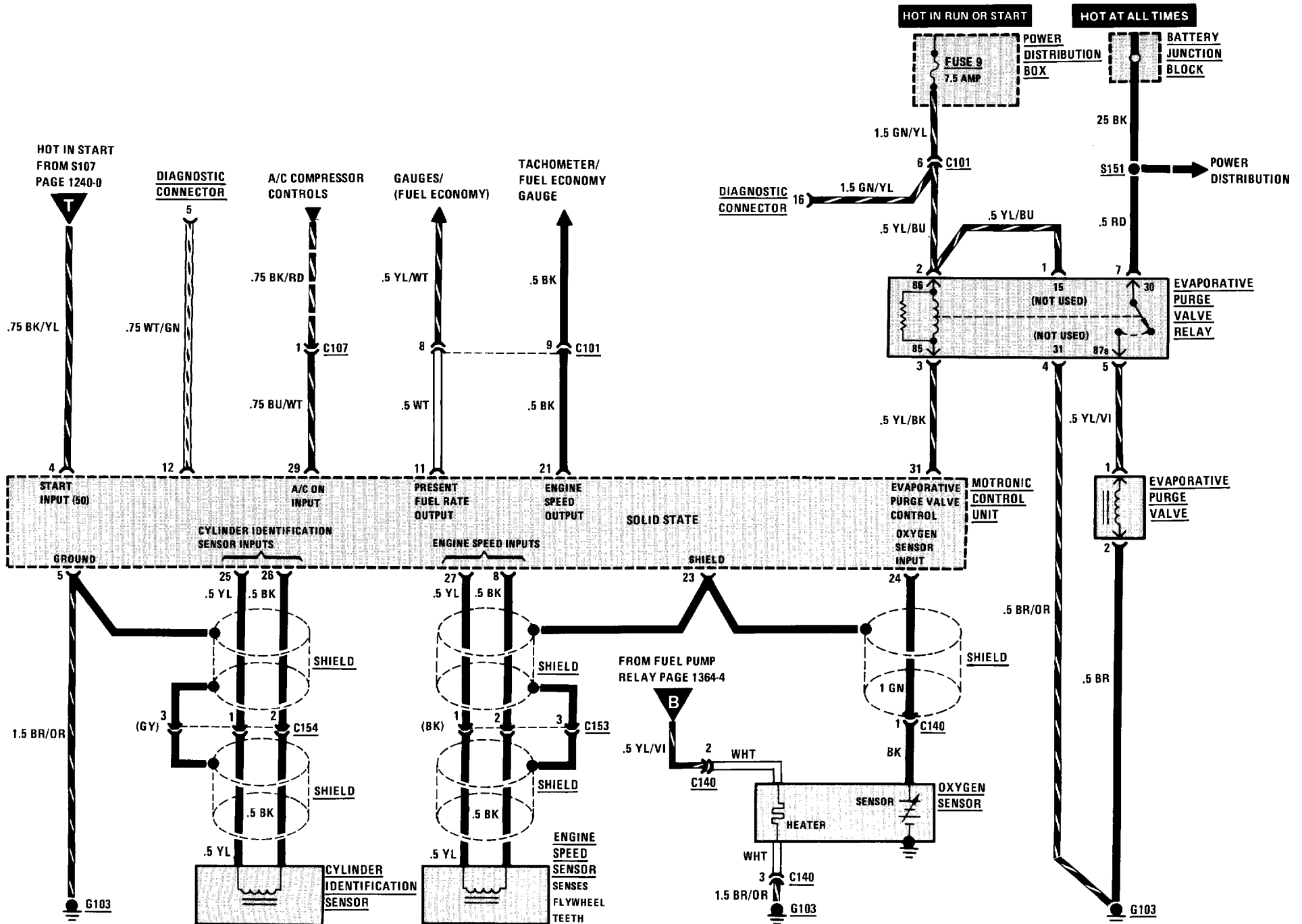

3234-0 SUPPLEMENTAL RESTRAINT SYSTEM (SRS)

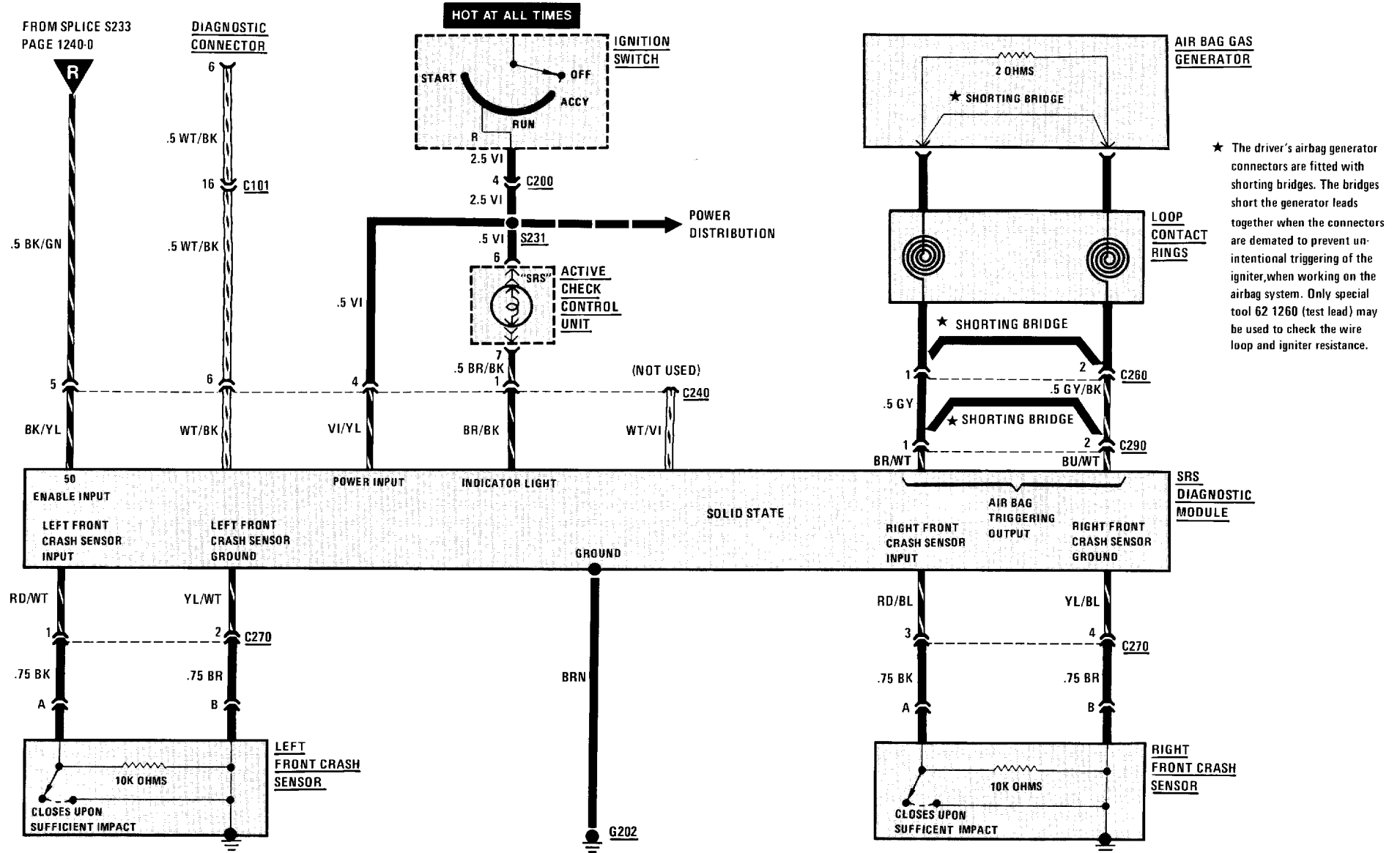

★ The driver's airbag generator connectors are fitted with shorting bridges. The bridges short the generator leads together when the connectors are demated to prevent unintentional triggering of the igniter, when working on the airbag system. Only special tool 62 1260 (test lead) may be used to check the wire loop and igniter resistance.

3450-0 ANTILOCK BRAKING SYSTEM (ABS)

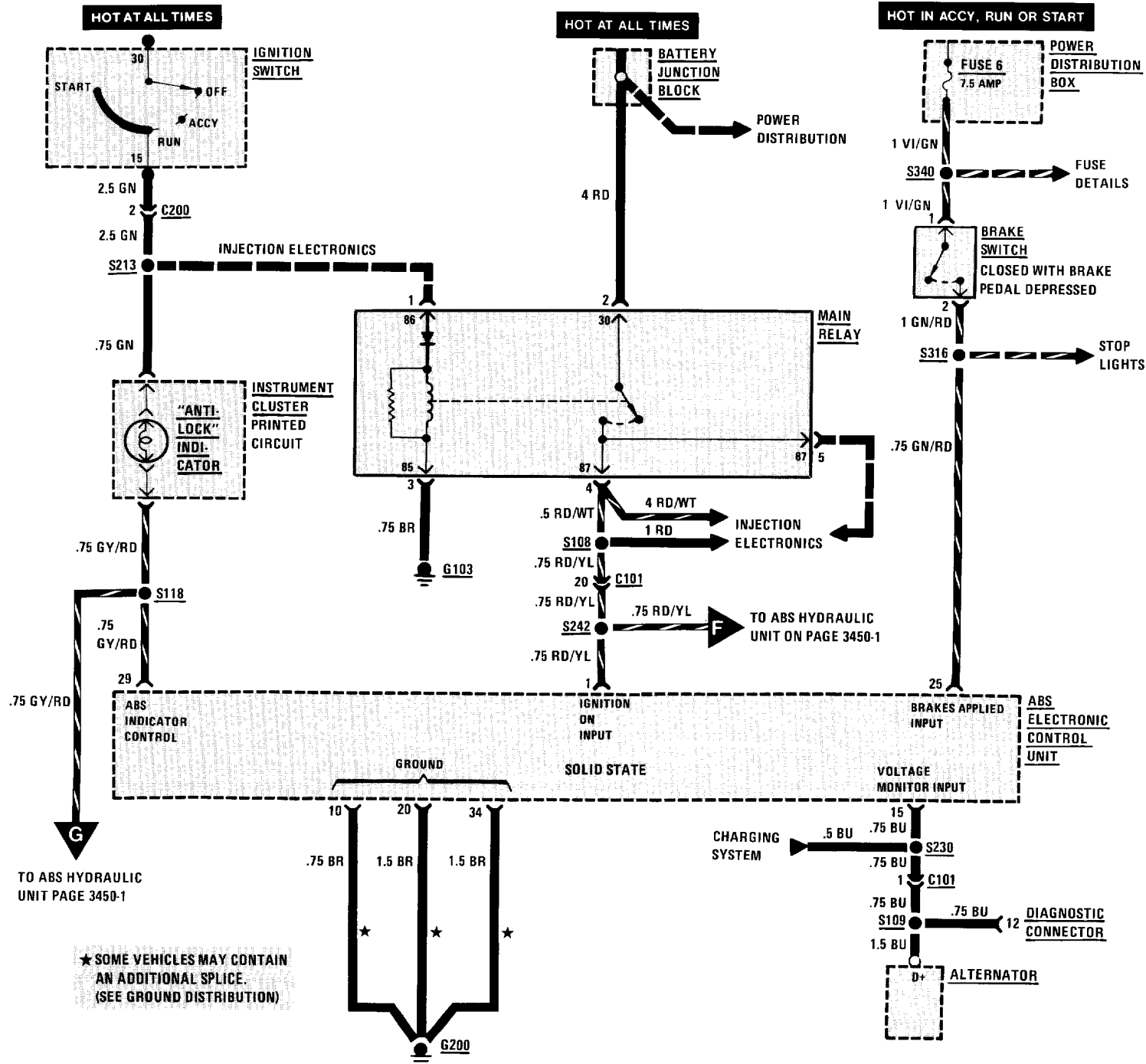

ANTILOCK BRAKING SYSTEM (ABS) 3450-1

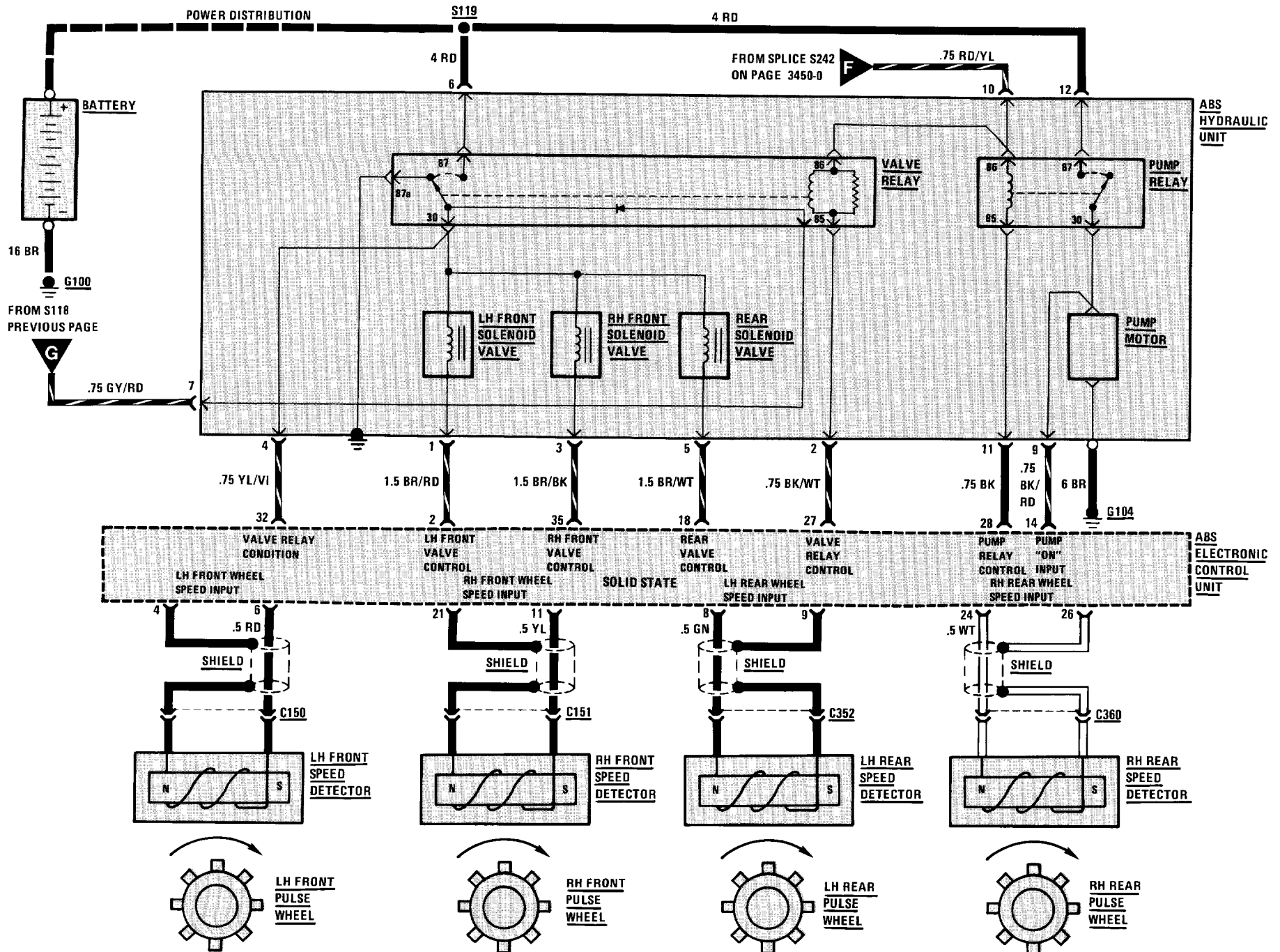

5116-0 POWER MIRRORS

HOT IN RUN ONLY FROM UNLOADER RELAY K7

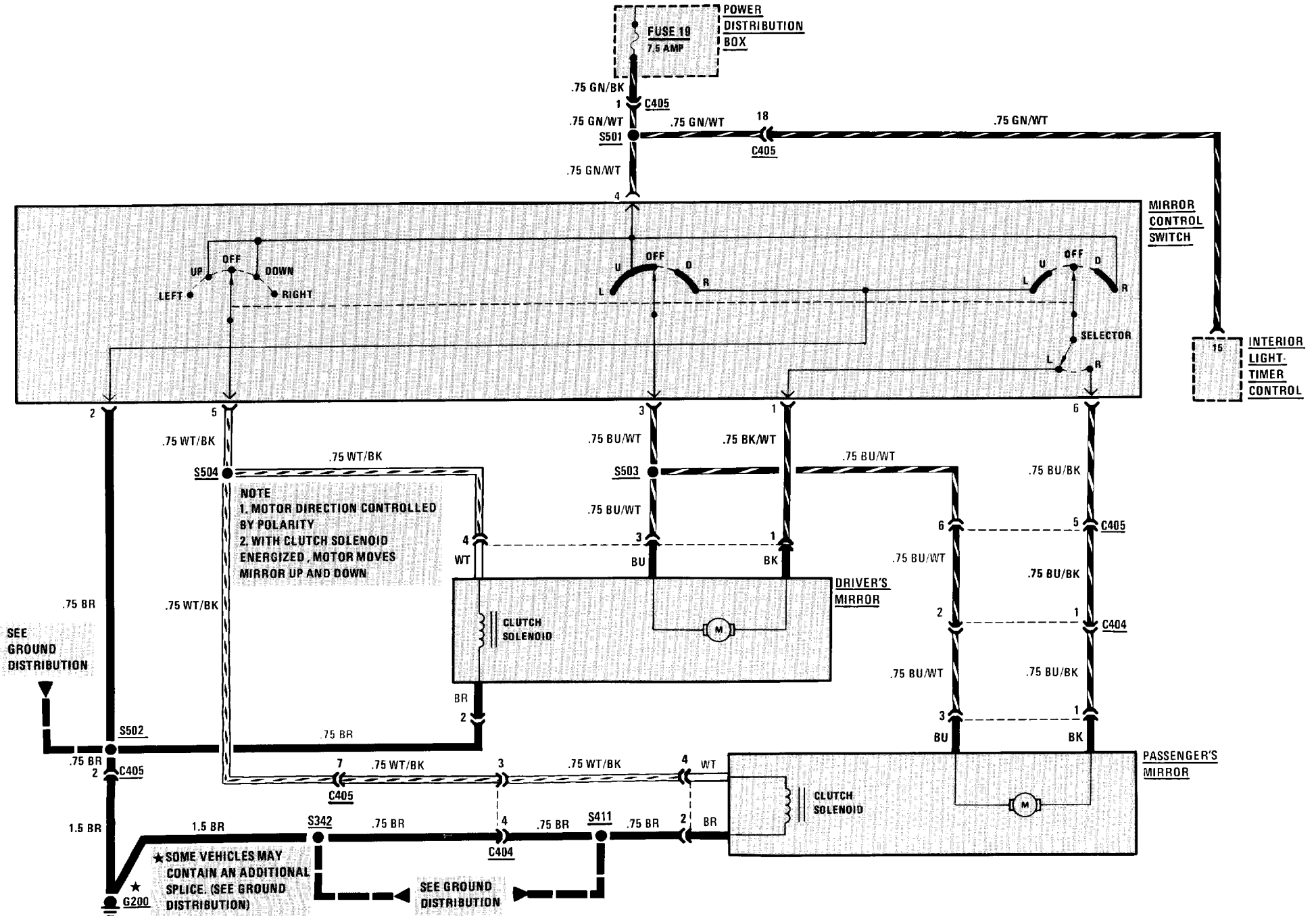

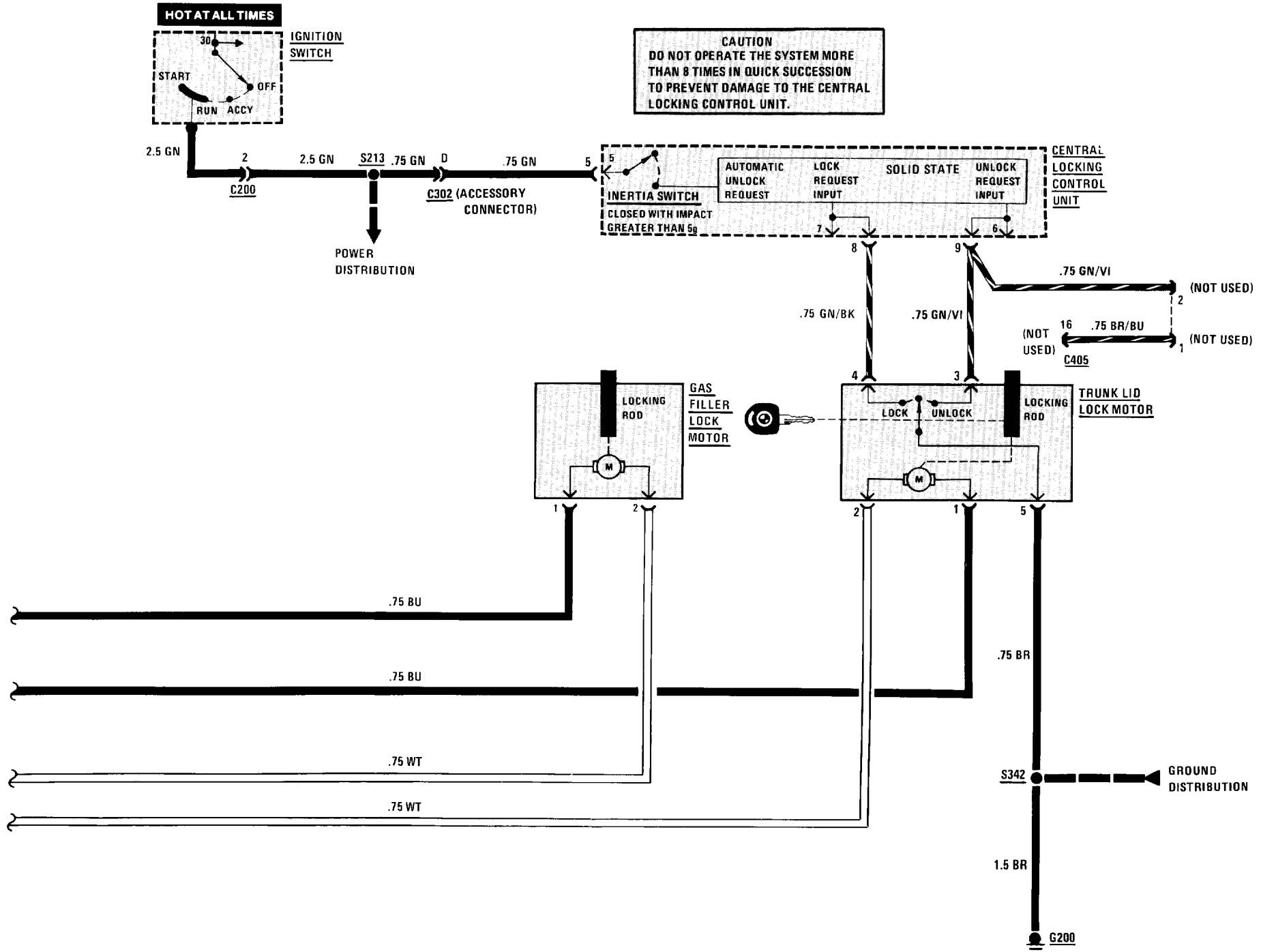

5126A-0 CENTRAL LOCKING

TROUBLESHOOTING HINTS

1. Check Fuse by operating the Interior Light Timer for either Dome Light.
2. If all locks stay in UNLOCK INHIBIT, check the wires to terminal 10 of the Central Locking Control Unit for a short to ground.

SYSTEM CHECK

- Operate controls in sequence listed in the System Check Table.
- Refer to Repair Action for the Response received (tests follow the System Check Table).
- After any repair, repeat System Check to verify proper system operation.

NOTE: Before replacing any system component, check all connectors, splices, and wiring to that component.

SYSTEM CHECK TABLE

OPERATION	RESPONSE	REPAIR ACTION
1. Insert the key in the Driver's door and turn to LOCK	All doors lock	None, proceed to Operation 2
	Some doors lock	Repair/replace the suspect Door Lock Motor circuit
	No doors lock	Proceed to Operation 4
2. Turn the key to UNLOCK INHIBIT (clockwise until key is horizontal)	All doors double lock (Safety Catch Buttons cannot be pulled up by hand)	None, proceed to Operation 3
	Driver's door double locks and only some of the other doors double lock	Repair/replace the suspect Door Lock Motor
	Driver's door double locks but no other doors double lock	Perform Test B
	Driver's door does not double lock	Mechanical problem, see BMW Workshop Manual

SYSTEM CHECK TABLE (CONT'D)

OPERATION	RESPONSE	REPAIR ACTION
3. Turn the key to UNLOCK	All doors unlock	None, proceed to Operation 4
	Some doors unlock	Repair/replace the suspect Door Lock Motor circuit
	No doors unlock	Proceed to Operation 5
4. Insert the key in the Passenger's door and turn to LOCK	All doors lock	If the doors did not lock in Operation 1, repair/replace the Driver's Door Lock Switch, otherwise proceed to Operation 5
	Some doors lock	Repair/replace the suspect Door Lock Motor circuit
	No doors lock	If all the doors locked in Operation 1, repair/replace the Right Front Door Microswitch. If the doors did not lock in Operation 1, perform Test A
5. Insert the key in the Passenger's door and turn to UNLOCK	All doors unlock	If all the doors did not unlock in Operation 3, repair/replace the Driver's Door Lock Switch, otherwise proceed to Operation 6
	Some doors unlock	Repair/replace the suspect Door Lock Motor
	No doors unlock	If all the doors unlocked in Operation 3, repair/replace the Passenger's Door Lock Switch. If the doors did not unlock in Operation 3, perform Test C
6. Get in the car and close and lock all doors Turn the Ignition Switch to RUN	Doors remain locked	None, proceed to Operation 7
	Doors unlock	Repair/replace the Central Locking Control Unit
7. Get out of the car Insert the key in the Driver's door and turn to LOCK Unlock each of the doors by pulling up the Safety Catch Buttons	All doors can be unlocked	None, proceed to Operation 8
	All doors remain secure	Disconnect the connector from the Central Locking Control Unit and check for a short to ground in the wires at terminal 11. <ul style="list-style-type: none"> • If short to ground is not present, replace the Central Locking Control Unit • If short to ground is present isolate wiring from Door Lock Motors one at a time to find short

5126A-2 CENTRAL LOCKING

SYSTEM CHECK TABLE (CONT'D)

OPERATION	RESPONSE	REPAIR ACTION
8. Insert the key in the Trunk Cylinder Switch. Turn the key to LOCK	Trunk locks	None, proceed to Operation 9
	Trunk does not lock	If the doors lock, repair/replace the Trunk Lock Motor Circuit or Trunk Lock Motor If the doors do not lock, repair/replace the Trunk Switch Repair/replace the Central Locking Control Unit if the Trunk Switch Circuit is OK
9. Turn the key to UNLOCK	Trunk unlocks	None, proceed to Operation 10
	Trunk does not unlock	If the doors unlock, repair/replace the Trunk Lock Motor circuit or Trunk Lock Motor If the doors do not unlock, repair/replace the Trunk Switch Repair/replace the Central Locking Control Unit if the Trunk Switch Circuit is OK
10. Turn the key back to LOCK	Gas Filler locks	None, proceed to Operation 11
	Gas Filler does not lock	Repair/replace the Gas Filler Lock Motor circuit
11. Turn the key to UNLOCK	Gas Filler unlocks	None
	Gas Filler does not unlock	Repair/replace the Gas Filler Lock Motor circuit

- If all results are normal, the system is OK.

SYSTEM DIAGNOSIS

- Do the following tests when directed by the System Check Table.

A: CONTROL UNIT LOCK TEST (TABLE 1)

Measure: VOLTAGE At: CONTROL UNIT CONNECTOR (Connected)		
Measure Between	Correct Voltage	For Diagnosis
3 & Ground	Battery	See 1
3 & 4	Battery	See 2
<ul style="list-style-type: none"> • If the voltages are correct, proceed to Table 2. <ol style="list-style-type: none"> 1. Check the wire to terminal 3 for an open. 2. Check the wire from terminal 4 for an open to ground (see schematic). 		

A: CONTROL UNIT LOCK TEST (TABLE 2)

Connect: A FUSED JUMPER At: CONTROL UNIT CONNECTOR (Connected)		
Jumper Between	Correct Result	For Diagnosis
7 & Ground	Doors lock	See 1
<ul style="list-style-type: none"> • If the result is correct, repair/replace the switches and related wiring (see schematic). <ol style="list-style-type: none"> 1. Proceed to Table 3. 		

**A: CONTROL UNIT LOCK TEST
(TABLE 3)**

Connect: FUSED JUMPERS At: CONTROL UNIT CONNECTOR (Disconnected)		
Jumper Between	Correct Result	For Diagnosis
1 & 3 2 & 4	Doors lock	See 1
<ul style="list-style-type: none"> If the result is correct, replace the Central Locking Control Unit. <ol style="list-style-type: none"> Check the wire from terminal 1 to splice and the wire from terminal 3 to splice for opens (see schematic). 		

B: UNLOCK INHIBIT TEST

Connect: A FUSED JUMPER At: CONTROL UNIT CONNECTOR (Connected)		
Jumper Between	Correct Result	For Diagnosis
10 & Ground	Doors double lock	See 1
<ul style="list-style-type: none"> If the result is correct, check the wires from terminal 10 to ground for opens (see schematic). Replace the Unlock Inhibit Switch if the wires and connections are OK. <ol style="list-style-type: none"> Check the wires from terminal 11 for opens (see schematic). Replace the Central Locking Control Unit, if the wires and connections are OK. 		

C: CONTROL UNIT UNLOCK TEST

Connect: A FUSED JUMPER At: CONTROL UNIT CONNECTOR (Connected)		
Jumper Between	Correct Result	For Diagnosis
6 & Ground	Doors unlock	See 1
<ul style="list-style-type: none"> If the result is correct, repair/replace the switches and related wiring (see schematic). <ol style="list-style-type: none"> Replace the Central Locking Control Unit. 		

CIRCUIT DESCRIPTION

The Central Locking System is controlled by the Central Locking Control Unit. This unit senses when a lock switch is moved by a key, and sends the appropriate signal to drive the Motors. The Central Locking Control Unit controls the Door Locks, Gas Filler Lock and Trunk Lock. The unit also has an Inertia Switch which closes on impact greater than 5g. If in RUN or START the locks are then unlocked.

Lock

When the Key is inserted into a lock and turned clockwise, the Lock switch moves to LOCK and grounds terminal 7 of the Central Locking Control Unit. The unit then activates the Lock Relay and applies voltage from Fuse 27 to the Lock Motor, which is grounded through the Central Locking Control Unit terminal 2. The Lock Motor then pulls the lock down. The door locks also control the Trunk Lock and Gas Filler Lock.

Unlock

When the key is turned counterclockwise, terminal 6 of the Central Locking Control Unit is grounded through the Lock Switch. The Central Locking Control Unit then activates the Unlock Relay and applies voltage from Fuse 27, through terminal 2 to the Lock Motor. The motor is grounded through the Central Locking Control Unit terminal 1. The polarity is reversed and the motor pushes the lock up.

Unlock Inhibit

When the key is inserted into the Driver's Lock and turned clockwise past the LOCK position, the Unlock Inhibit mechanism is engaged. This mechanically inserts a bar into the driver's lock and prevents unlocking through use of the Safety Catch Button. When in the Unlock Inhibit position, ground is applied to the Unlock Inhibit motors in the other lock units. The Central Locking Control Unit is grounded at terminal 10 and then activates the Lock Relay. Voltage is applied to the Unlock Inhibit motors through terminal 1. They are now activated and engage the other Unlock Inhibit mechanisms. The direction of the motors is reversed when the doors are unlocked (see Unlock).

Trunk Lock

The Trunk Lock operates in a manner similar to the Door Locks.

5133-0 POWER WINDOWS

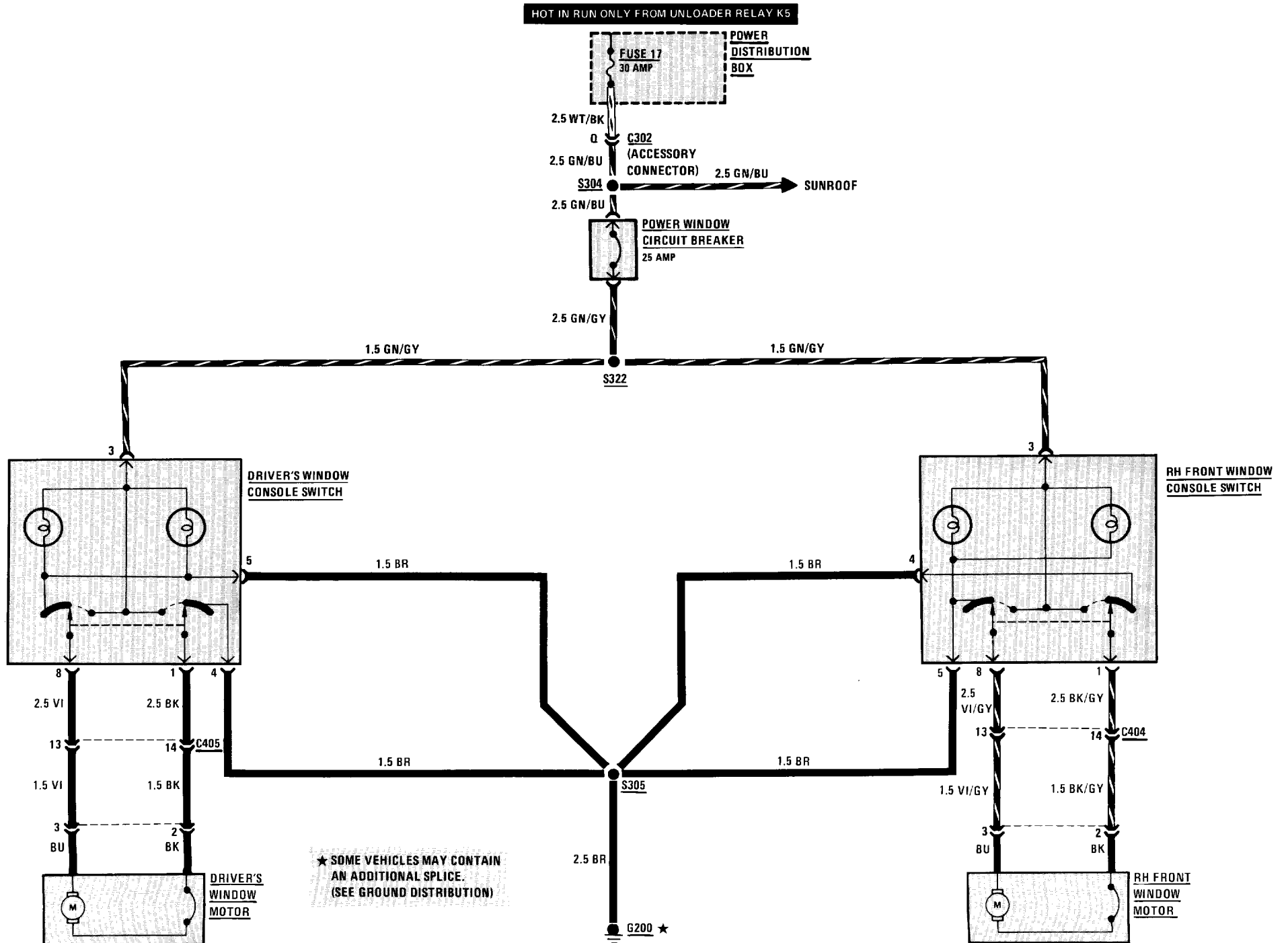

HEATED SEATS

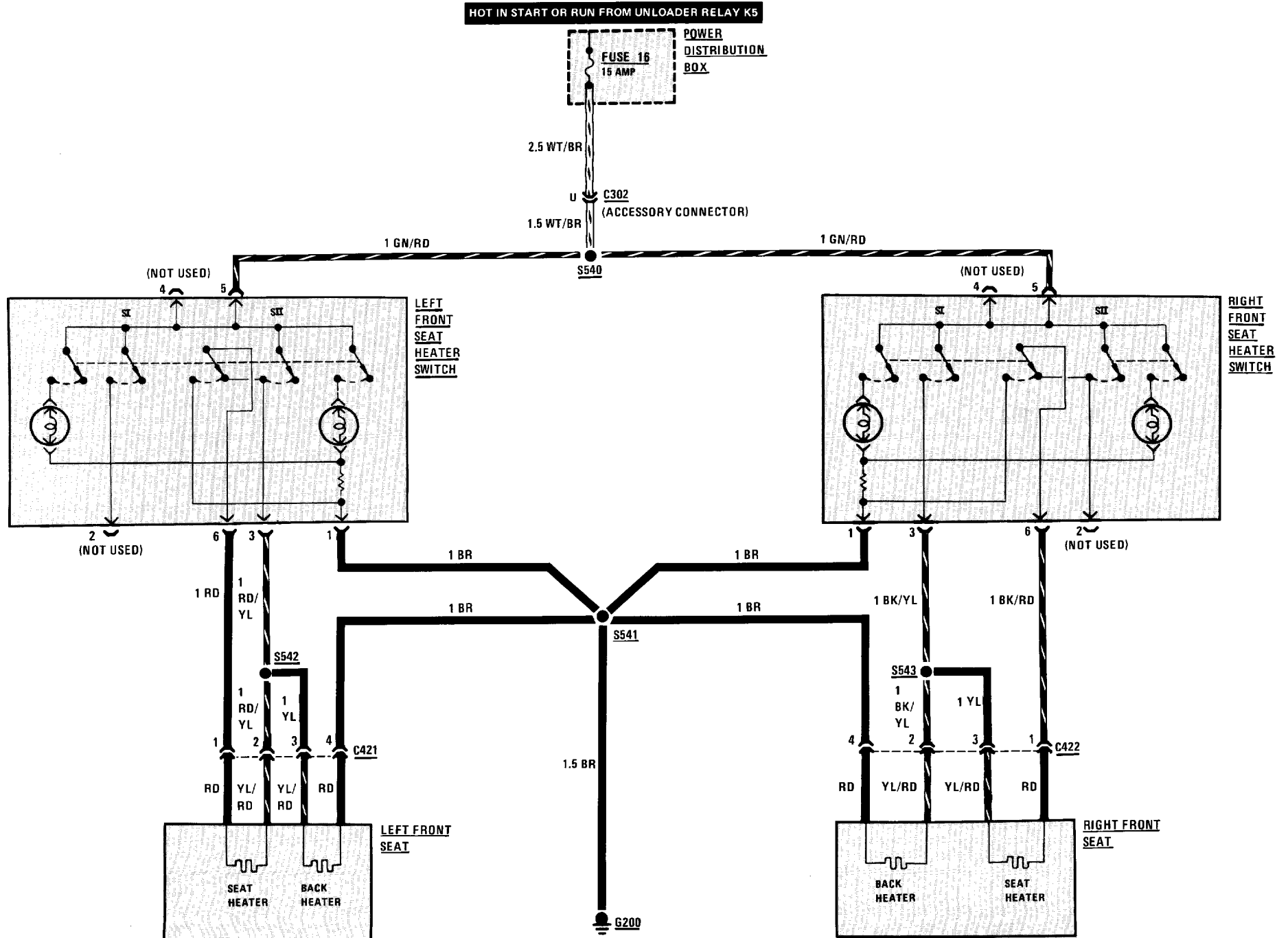

5413-0 SUNROOF

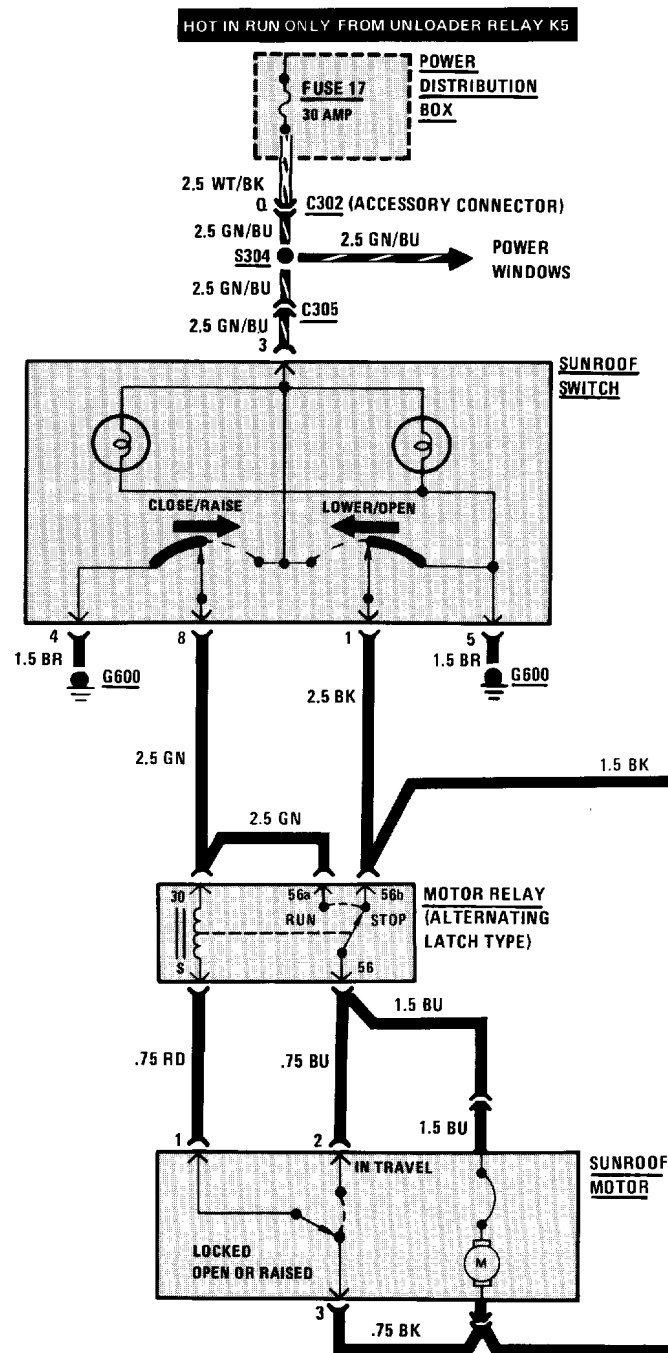

6100-0 BODY ELECTRICAL

HORNS

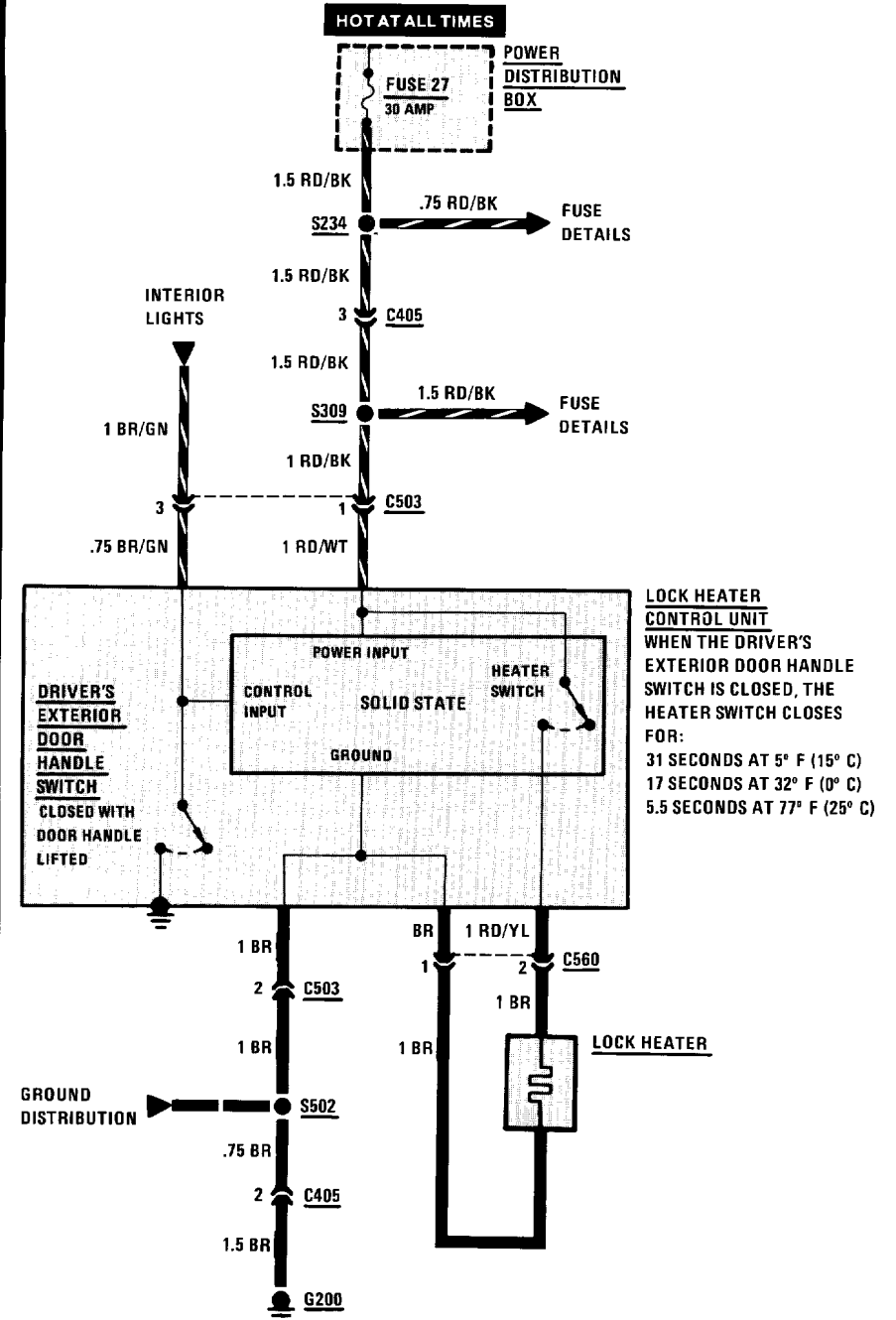
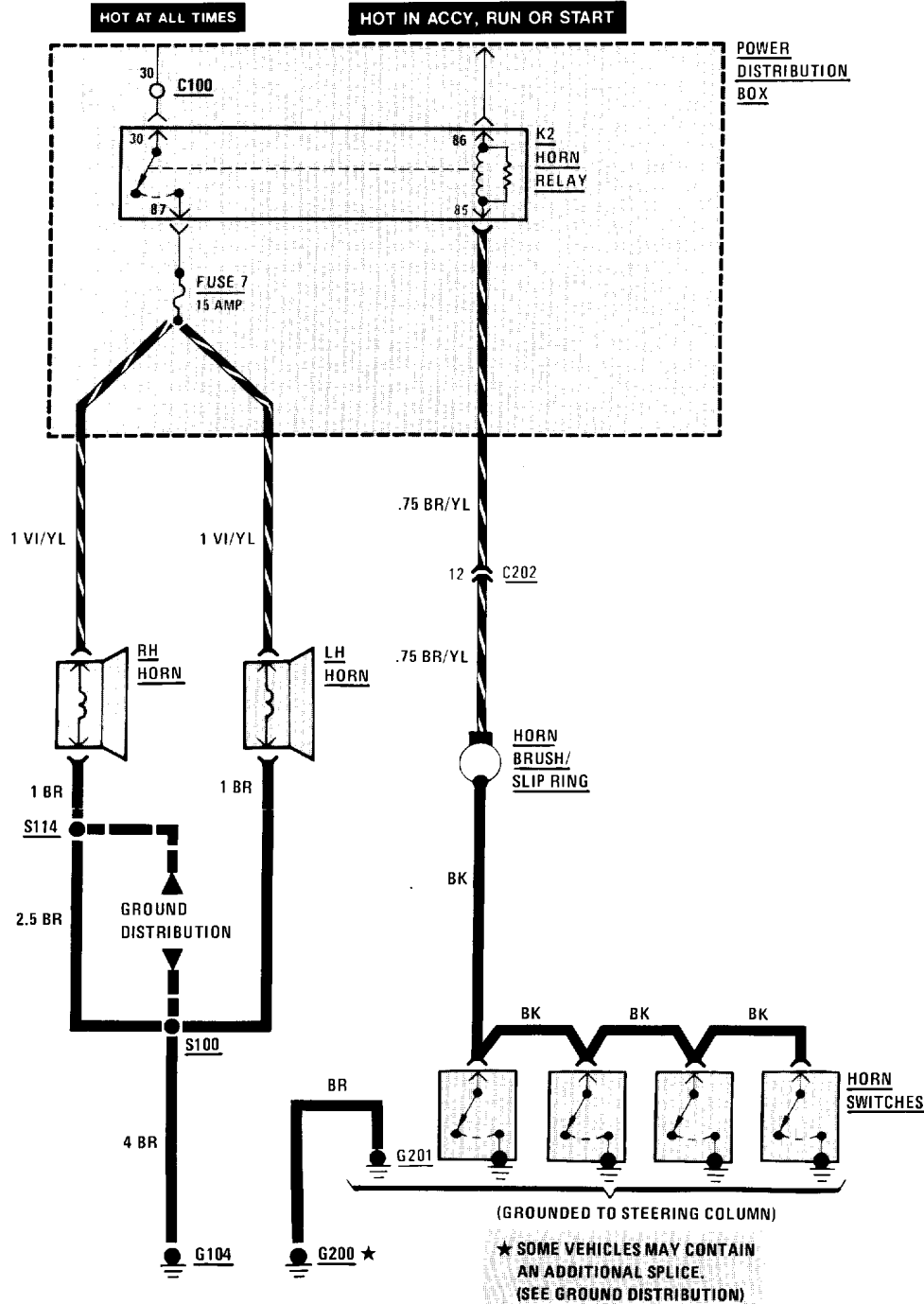

6100-2 BODY ELECTRICAL

REAR DEFOGGER

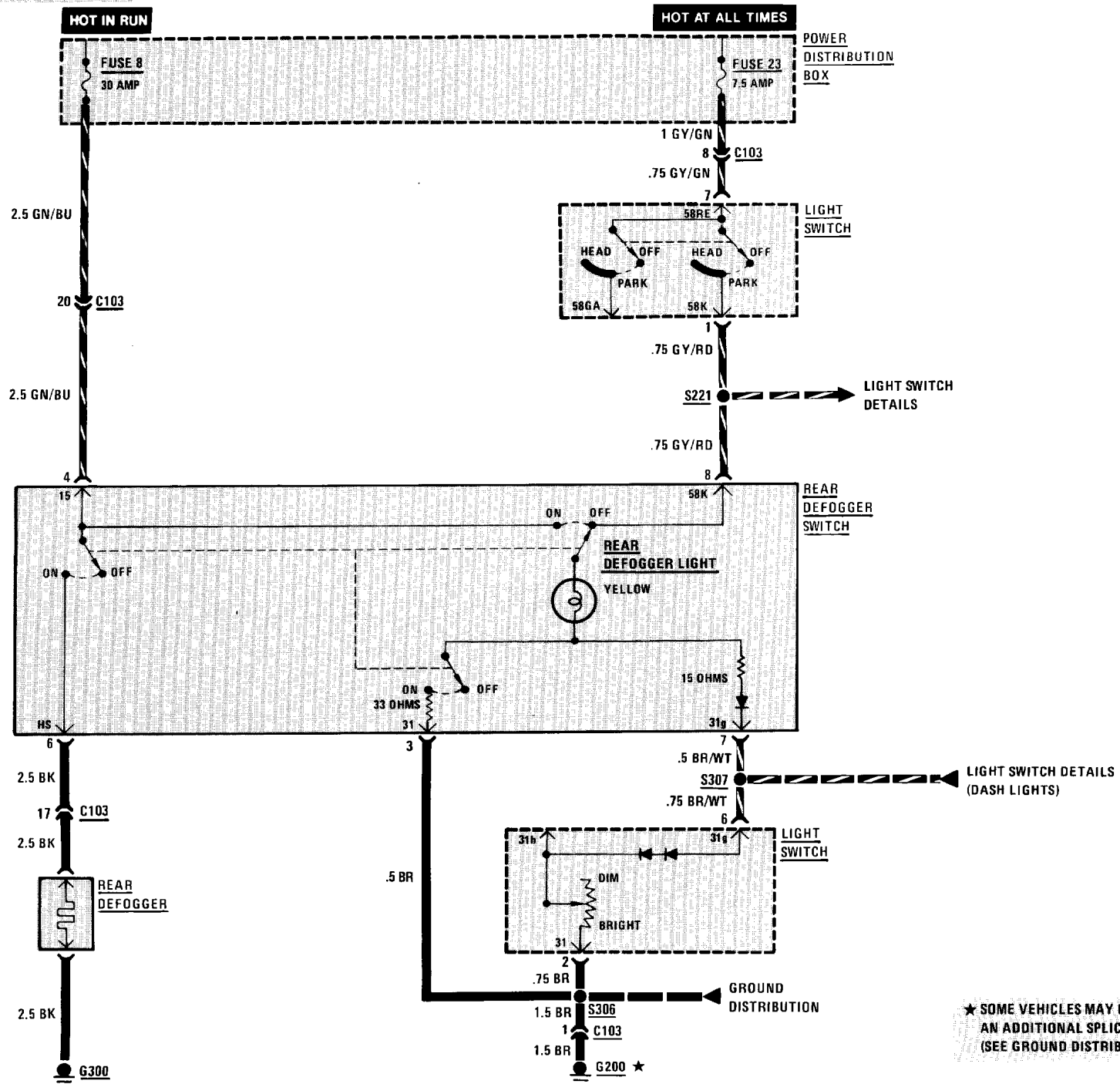

6131-0 IGNITION KEY WARNING/SEATBELT WARNING

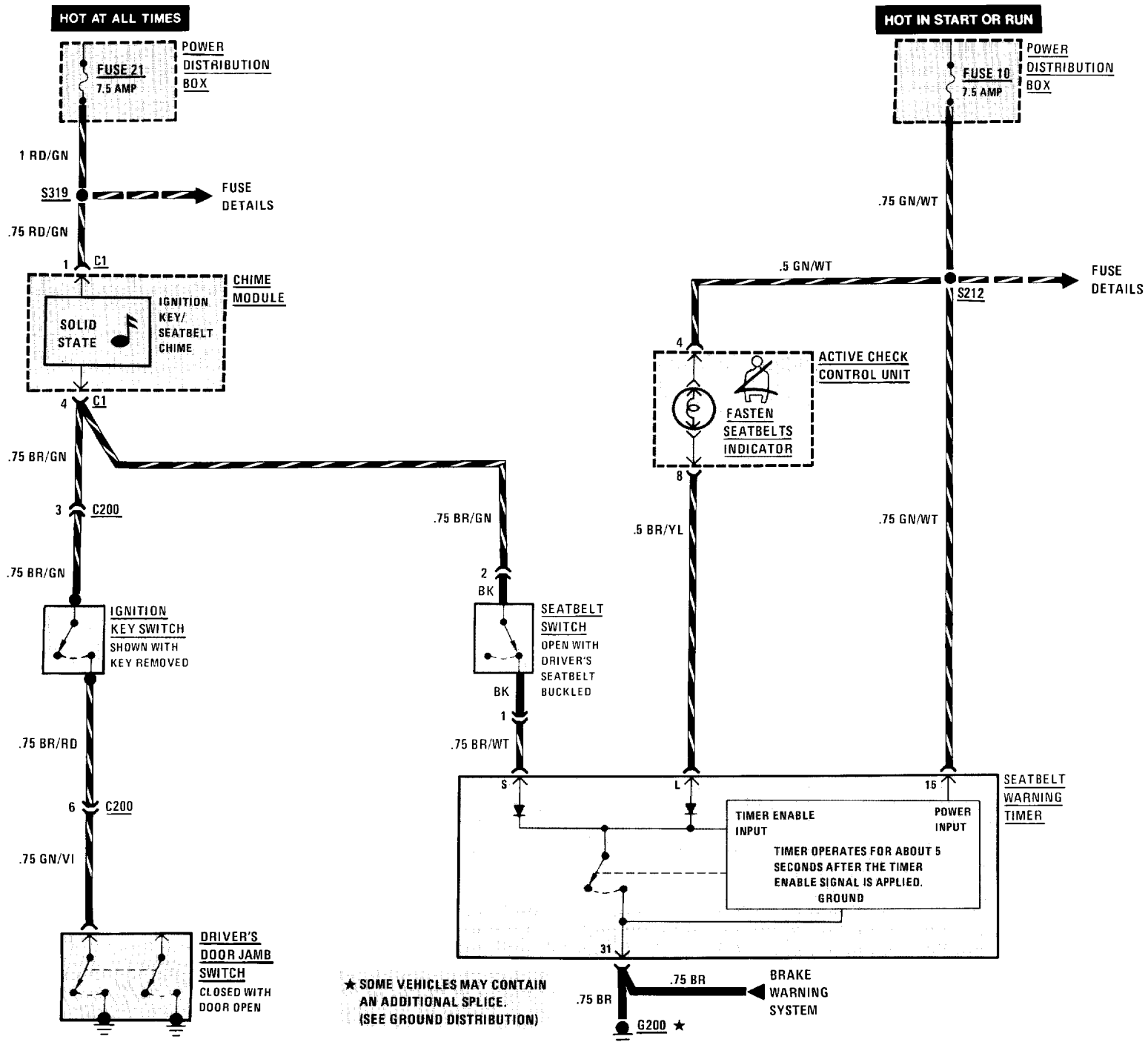

6160-0 WIPER/WASHER

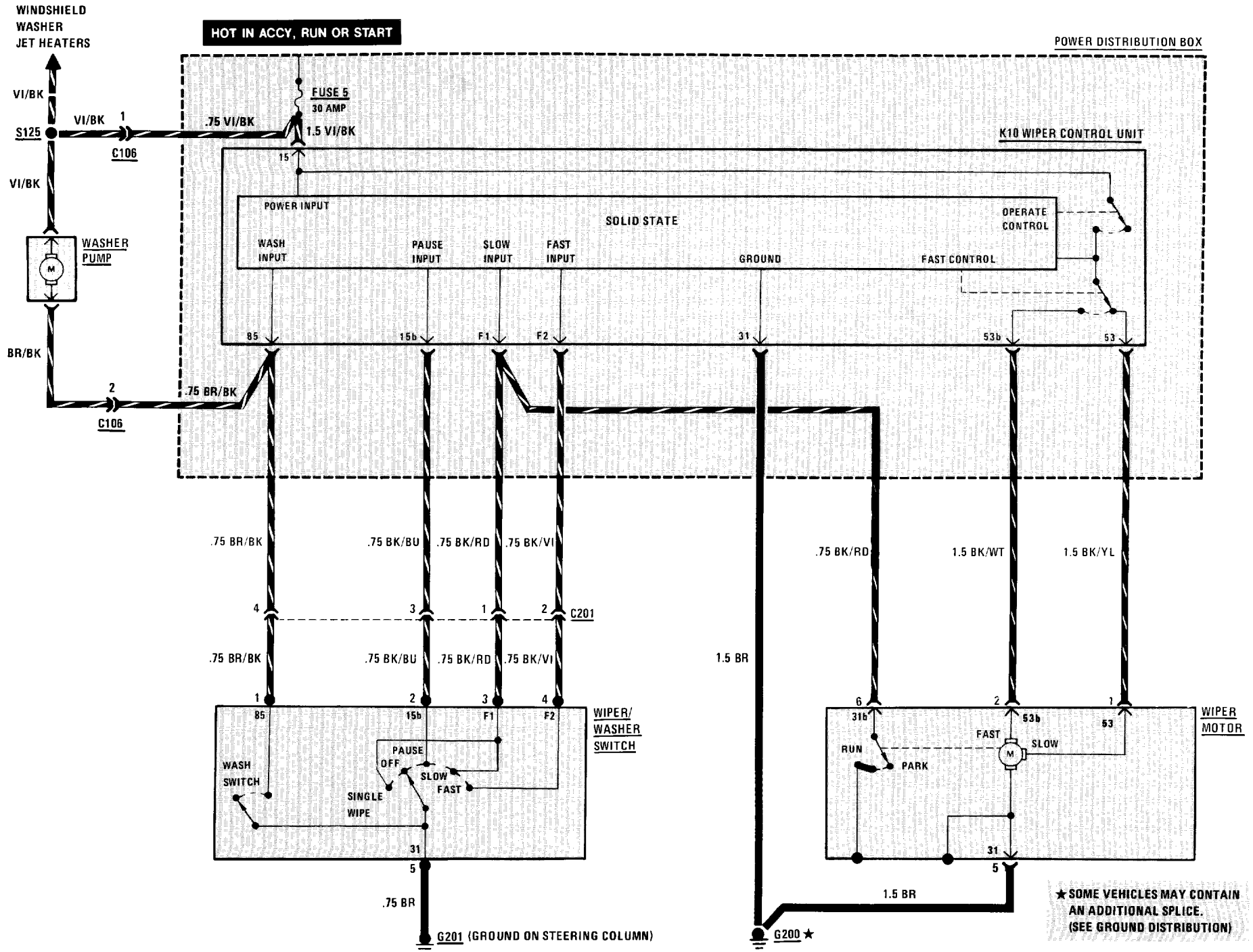

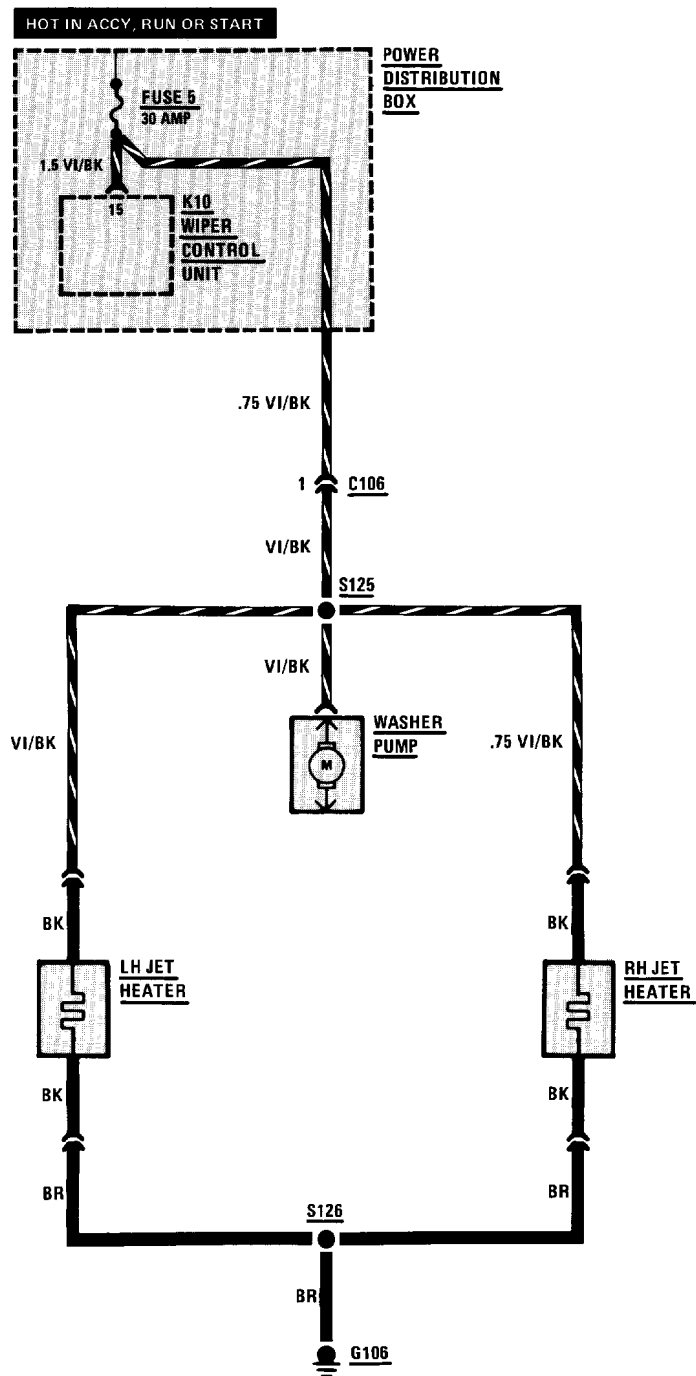

6210-0 INSTRUMENT CLUSTER

SPEEDOMETER/INDICATORS

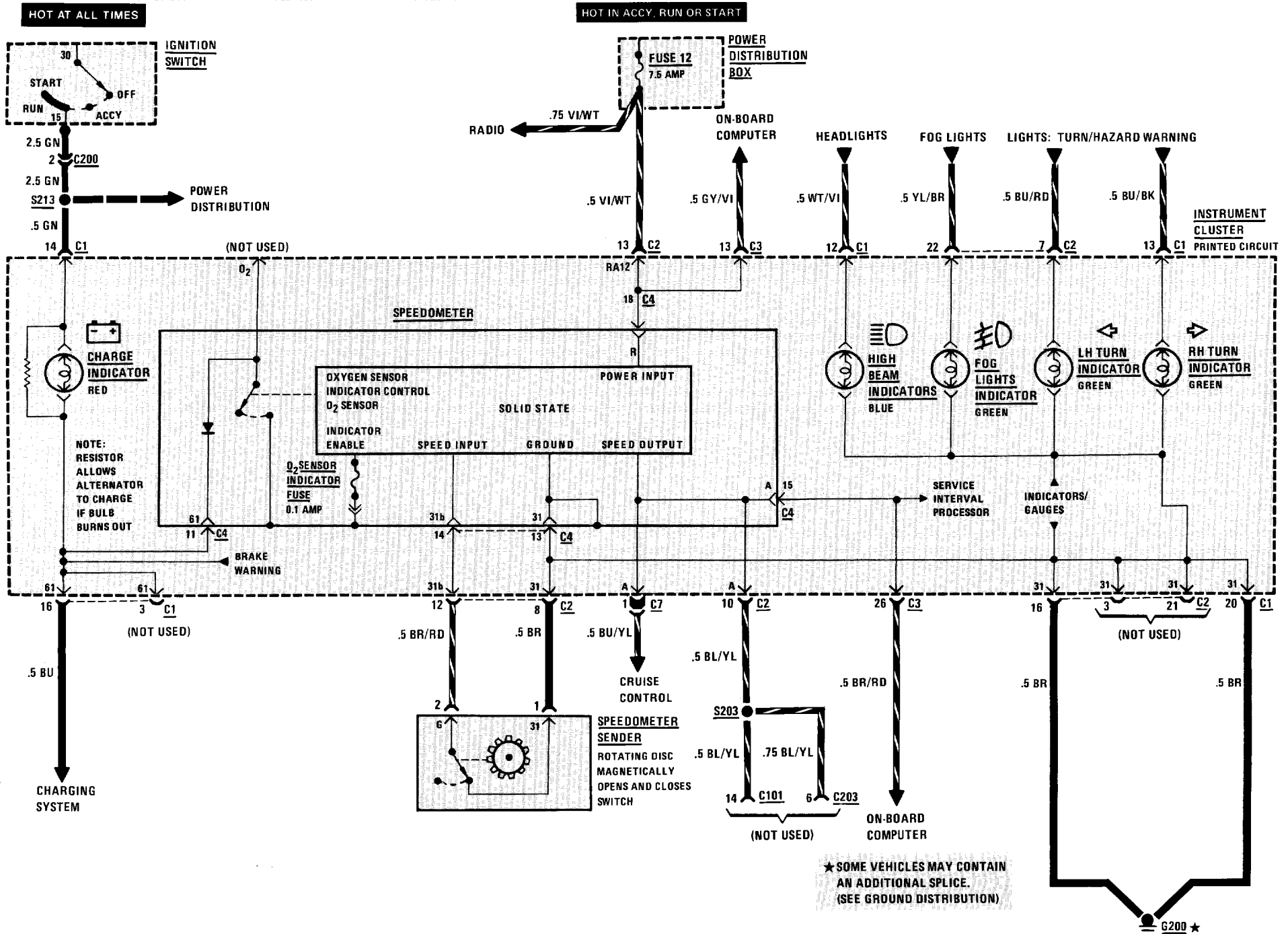

SERVICE INTERVAL INDICATOR

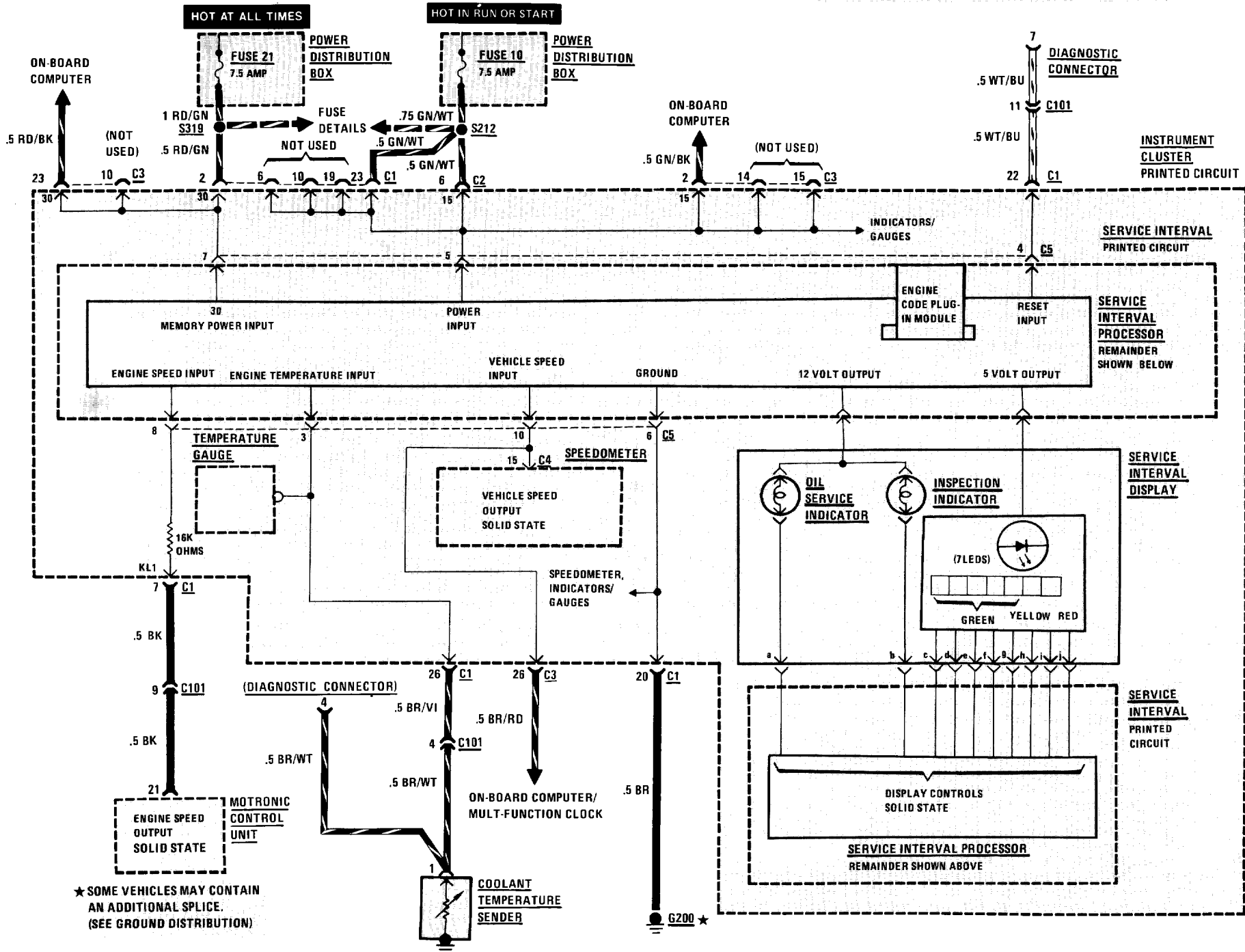

★ SOME VEHICLES MAY CONTAIN AN ADDITIONAL SPLICE. (SEE GROUND DISTRIBUTION)

6210-2 INSTRUMENT CLUSTER

GAUGES

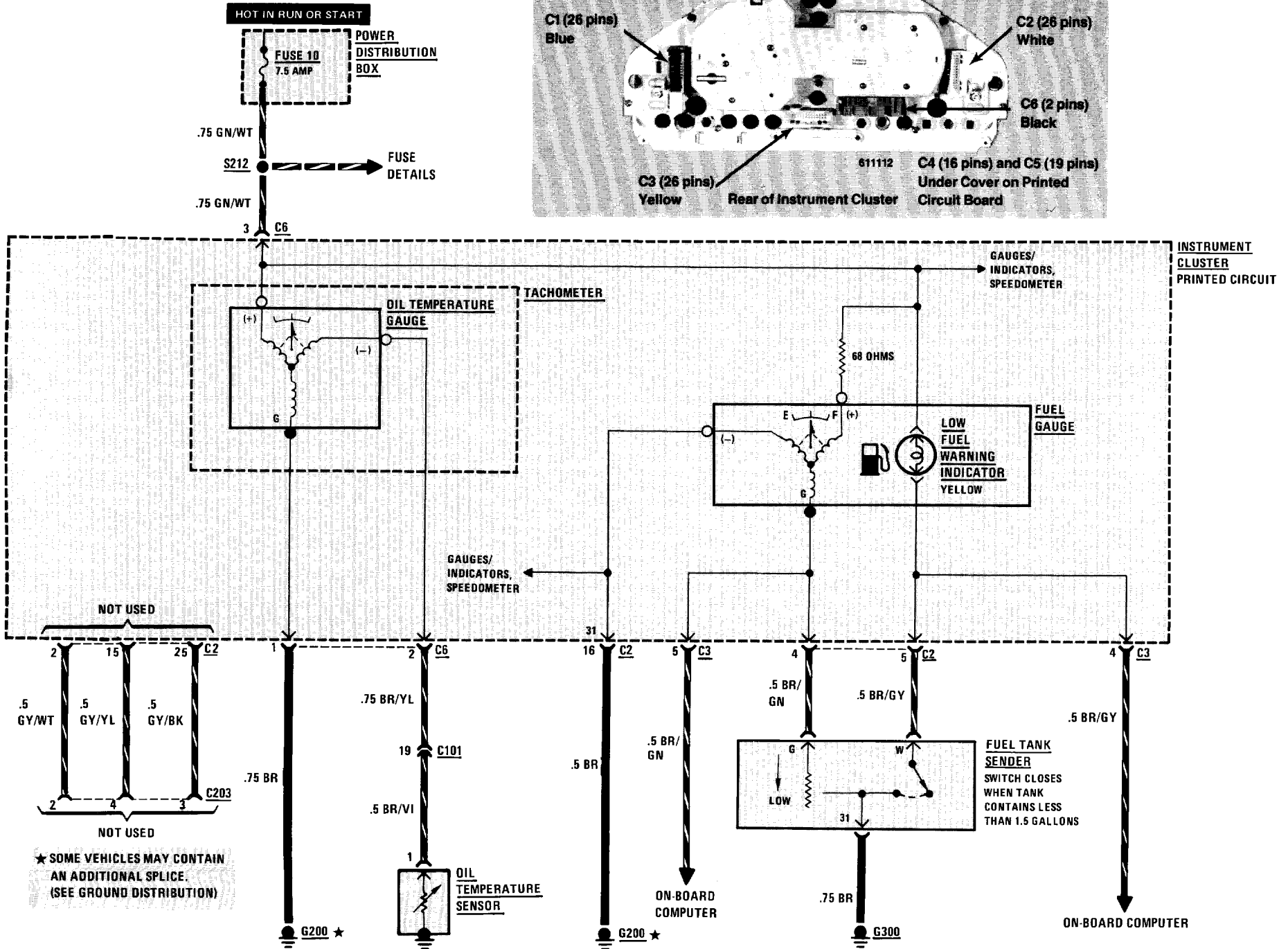
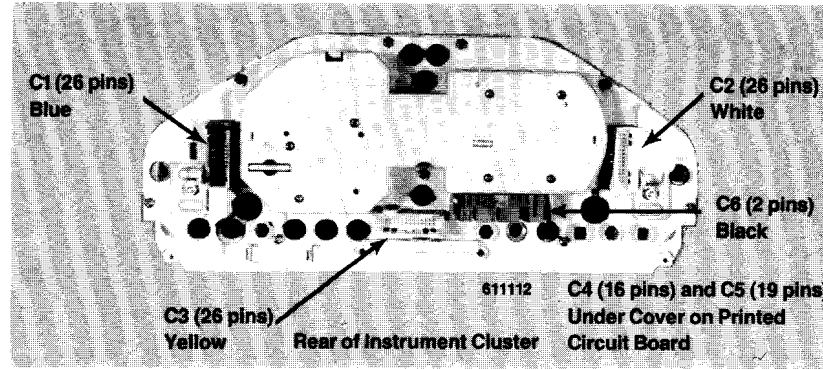

TACHOMETER/FUEL ECONOMY GAUGE

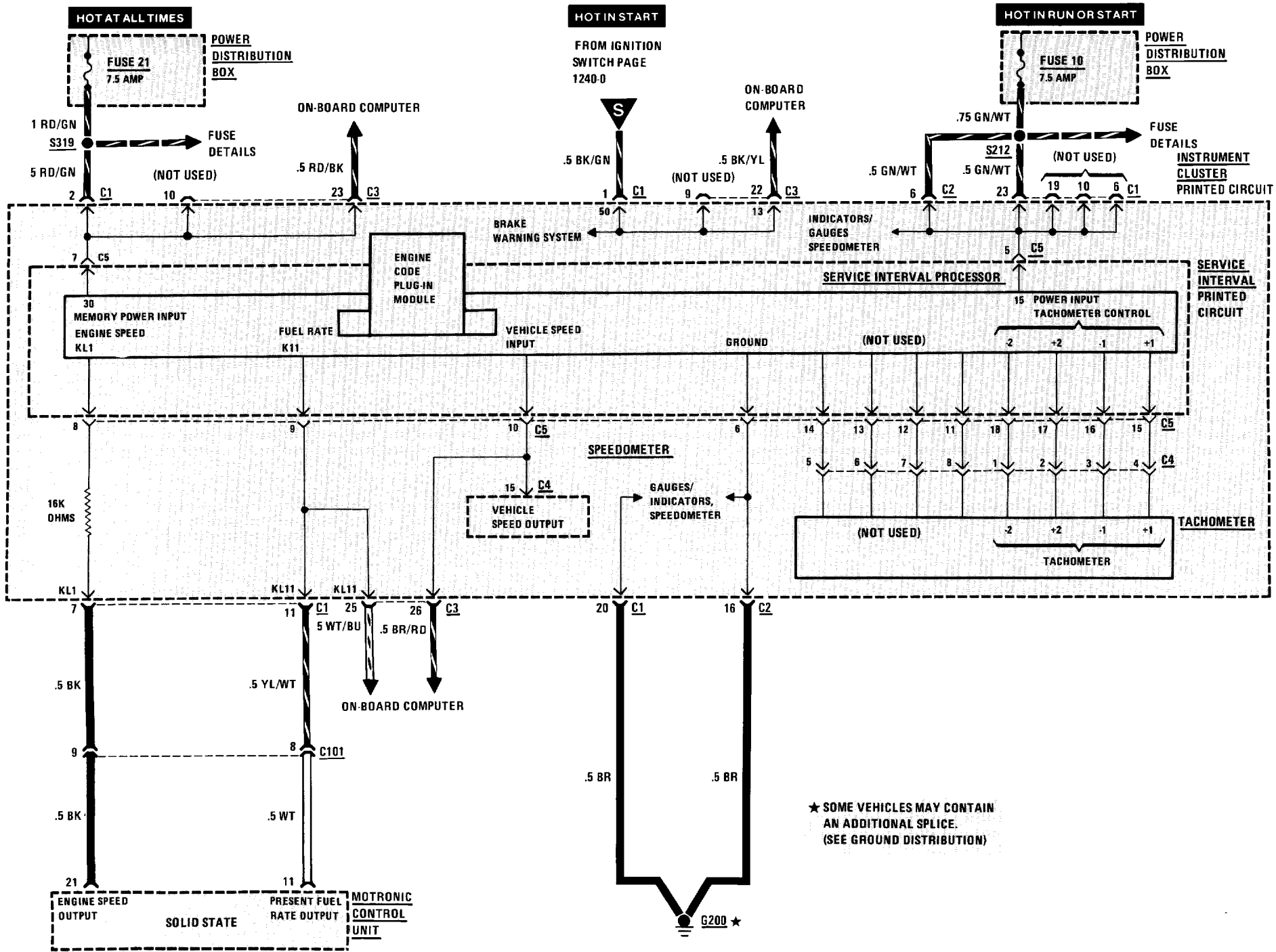

★ SOME VEHICLES MAY CONTAIN AN ADDITIONAL SPLICE. (SEE GROUND DISTRIBUTION)

6210-4 INSTRUMENT CLUSTER

GAUGES/INDICATORS

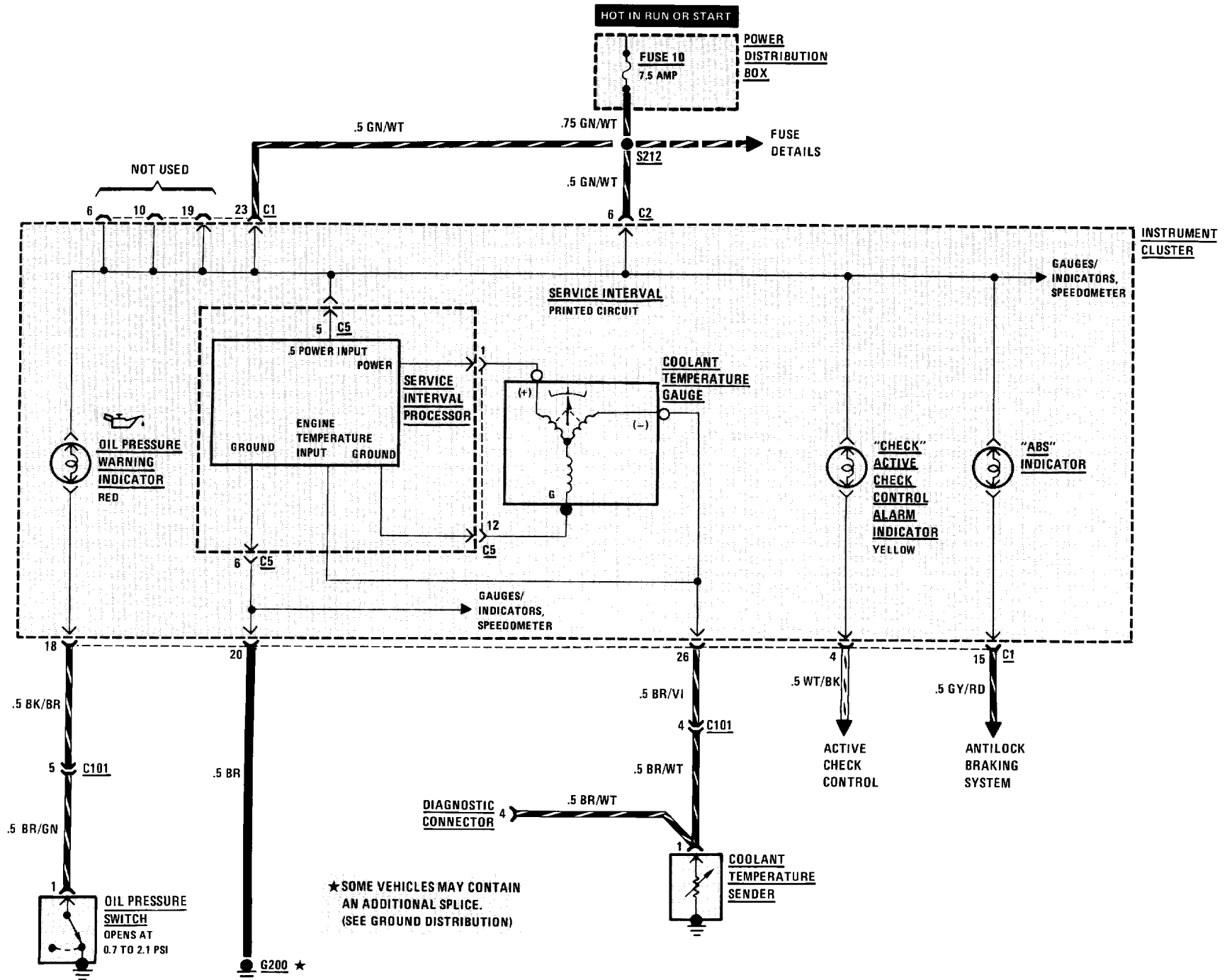

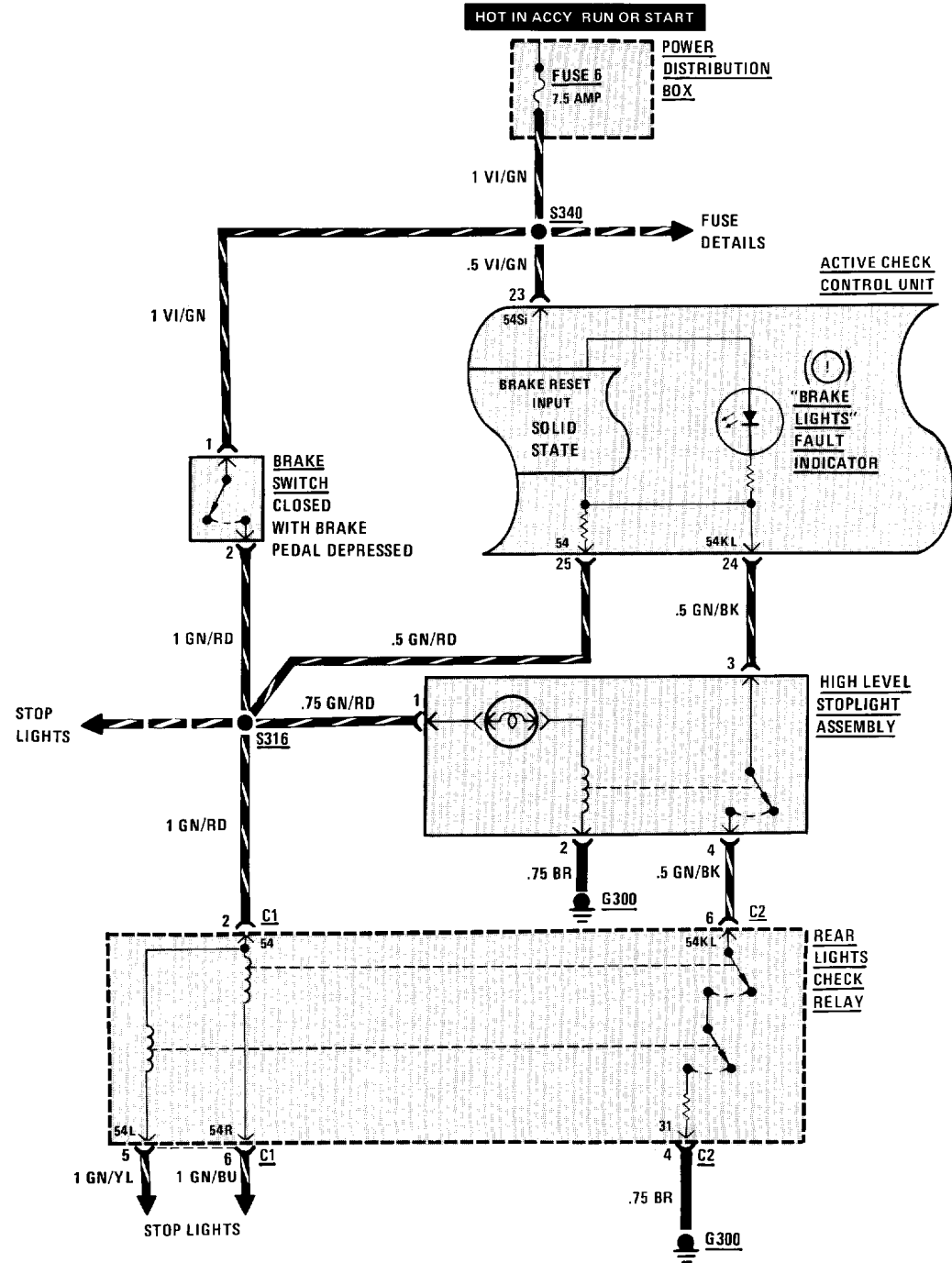
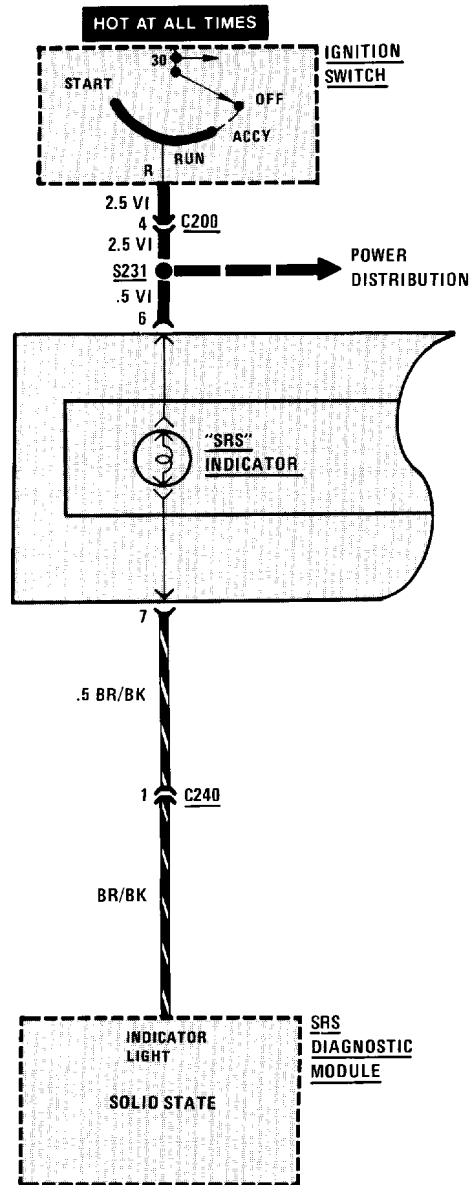

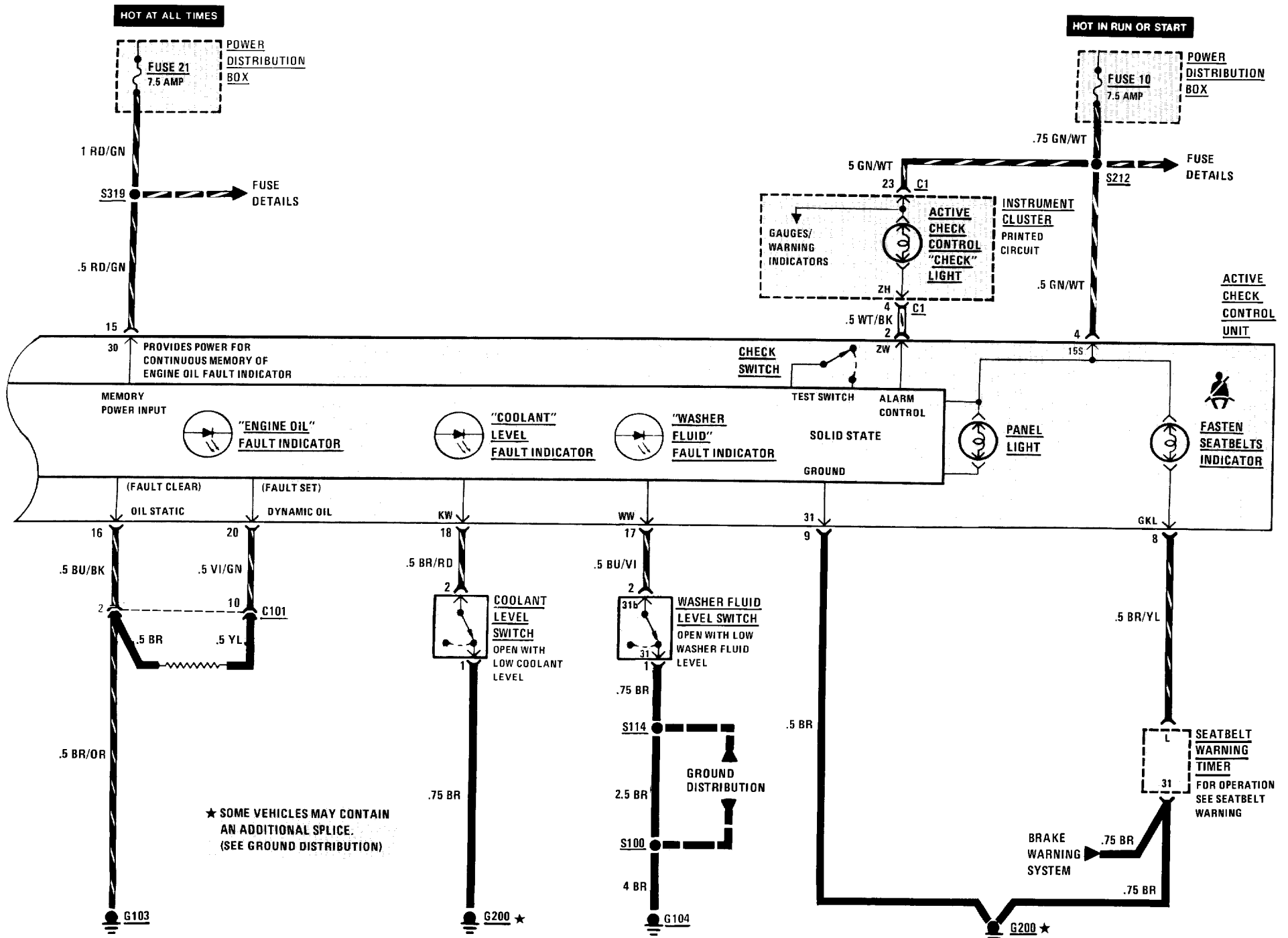

6300-0 LIGHT SWITCH DETAILS

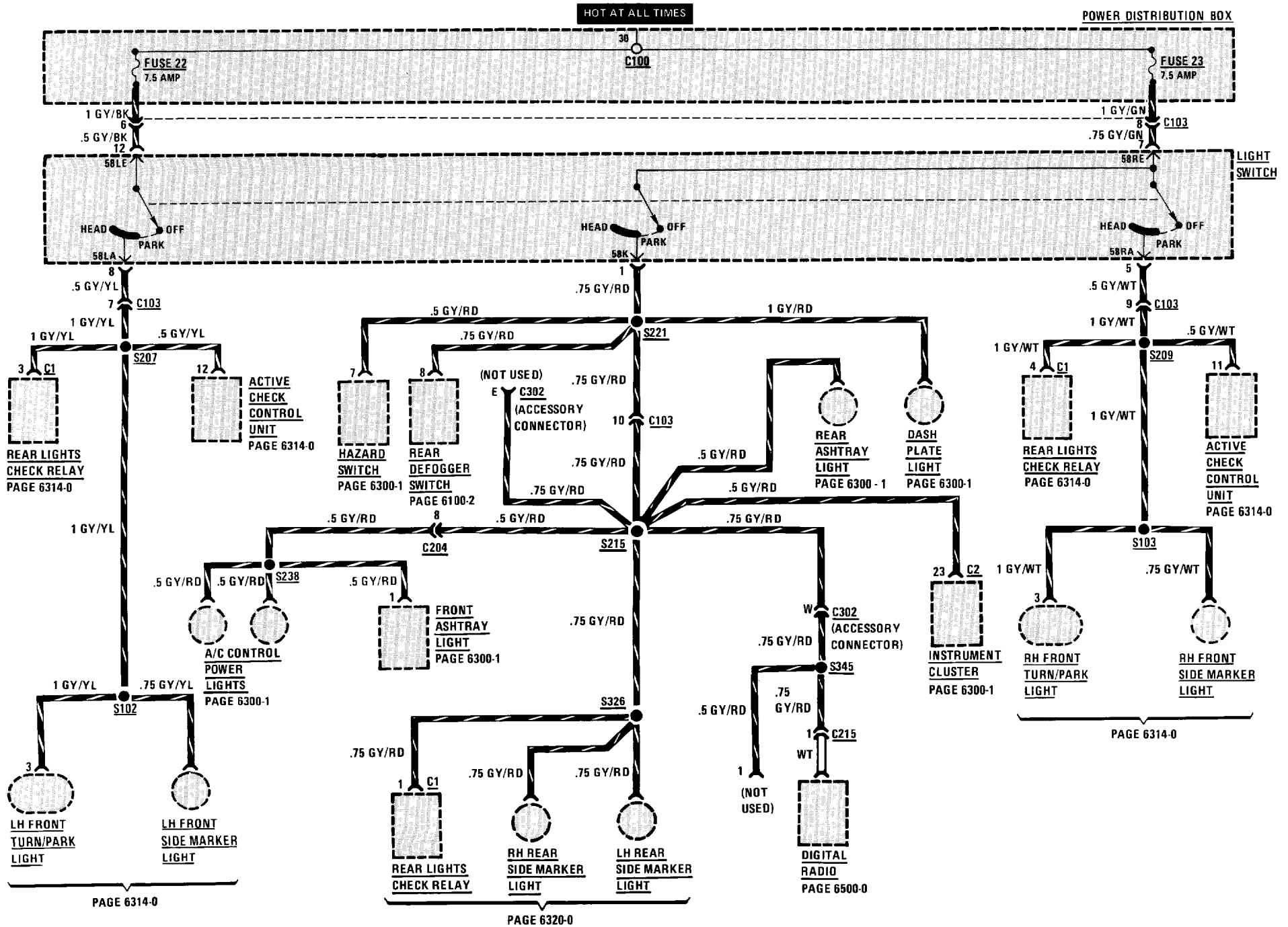

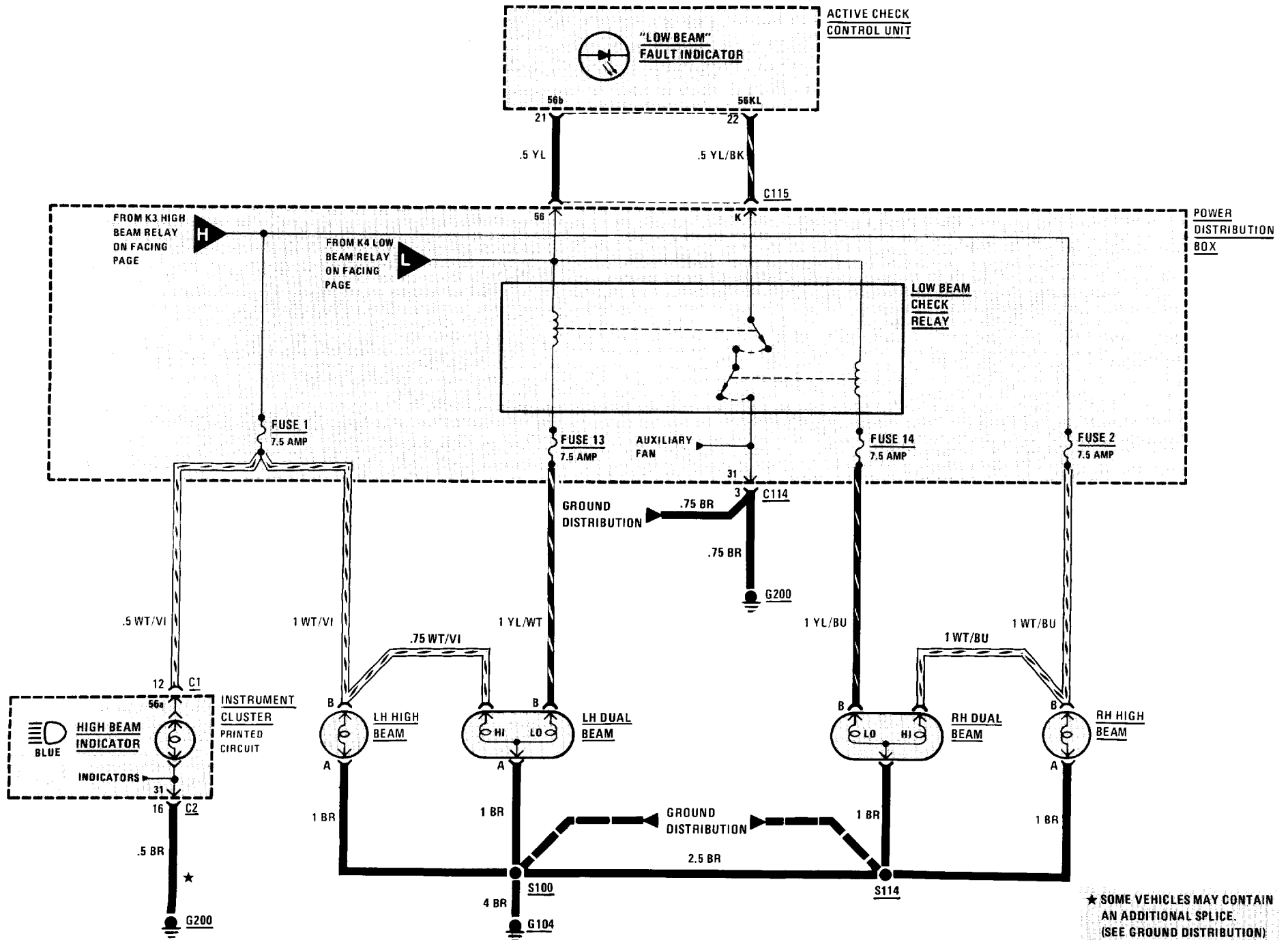

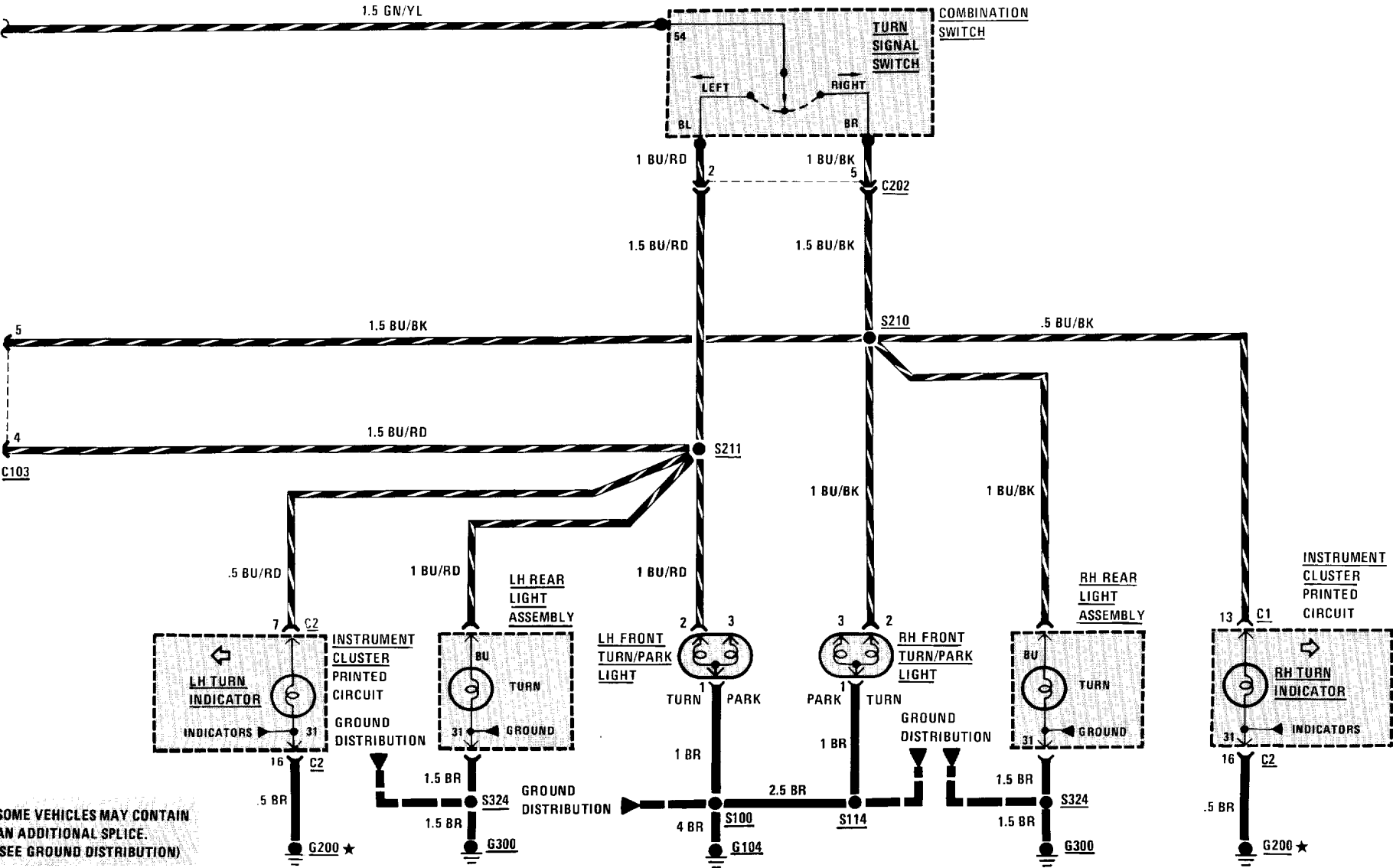

★ SOME VEHICLES MAY CONTAIN AN ADDITIONAL SPLICE. (SEE GROUND DISTRIBUTION)

6314-0 PARK/TAIL/FRONT MARKER LIGHTS

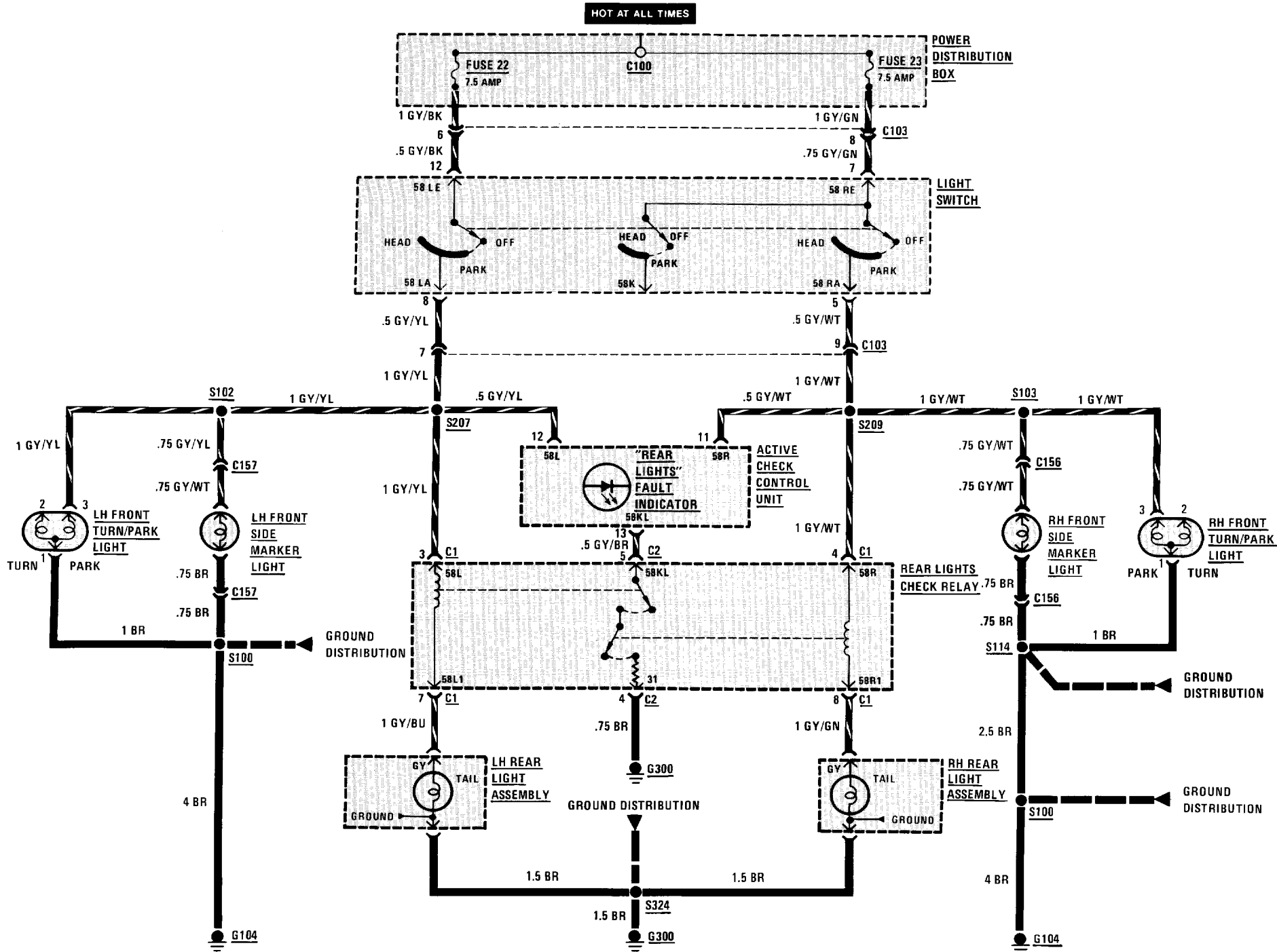

6320-0 REAR MARKER/LICENSE/TRUNK LIGHTS

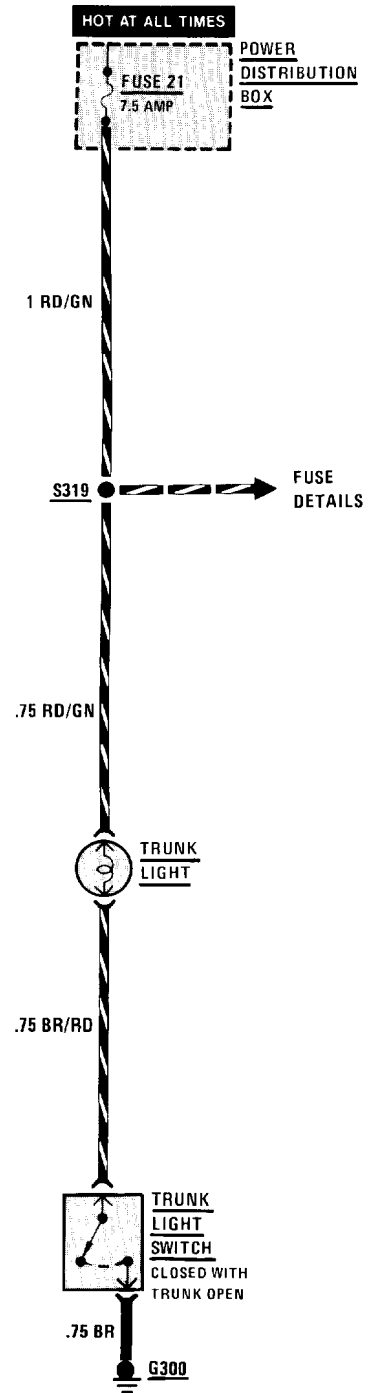
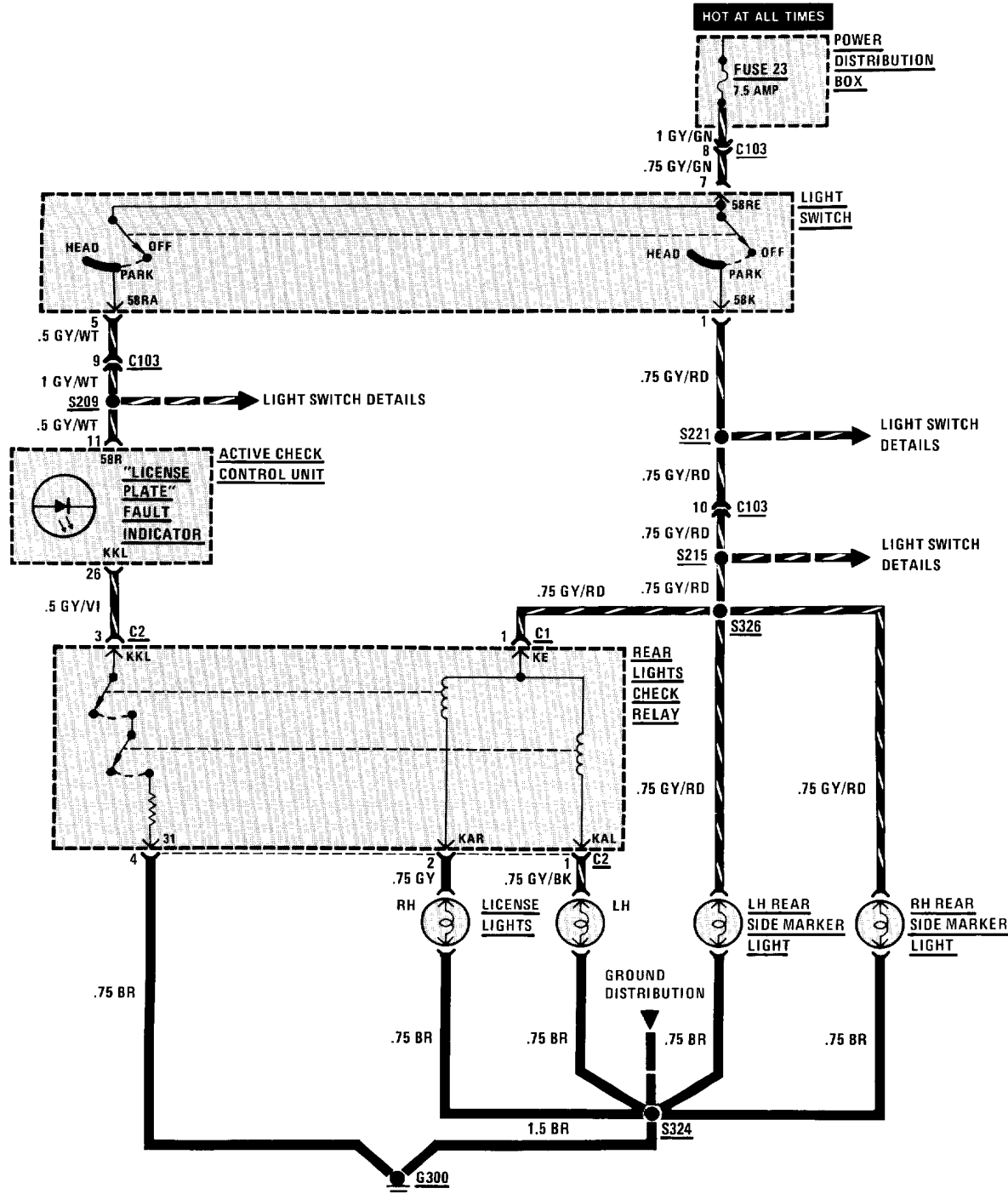

6322-0 BACKUP LIGHTS

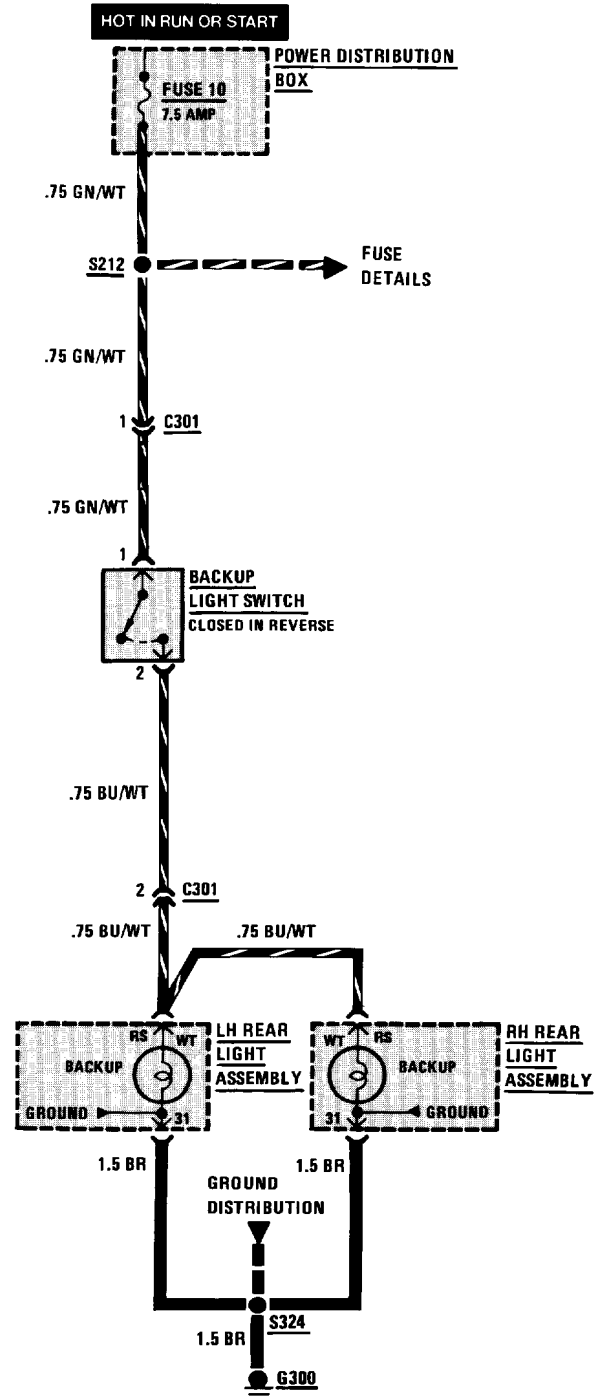

6330-0 INTERIOR LIGHTS

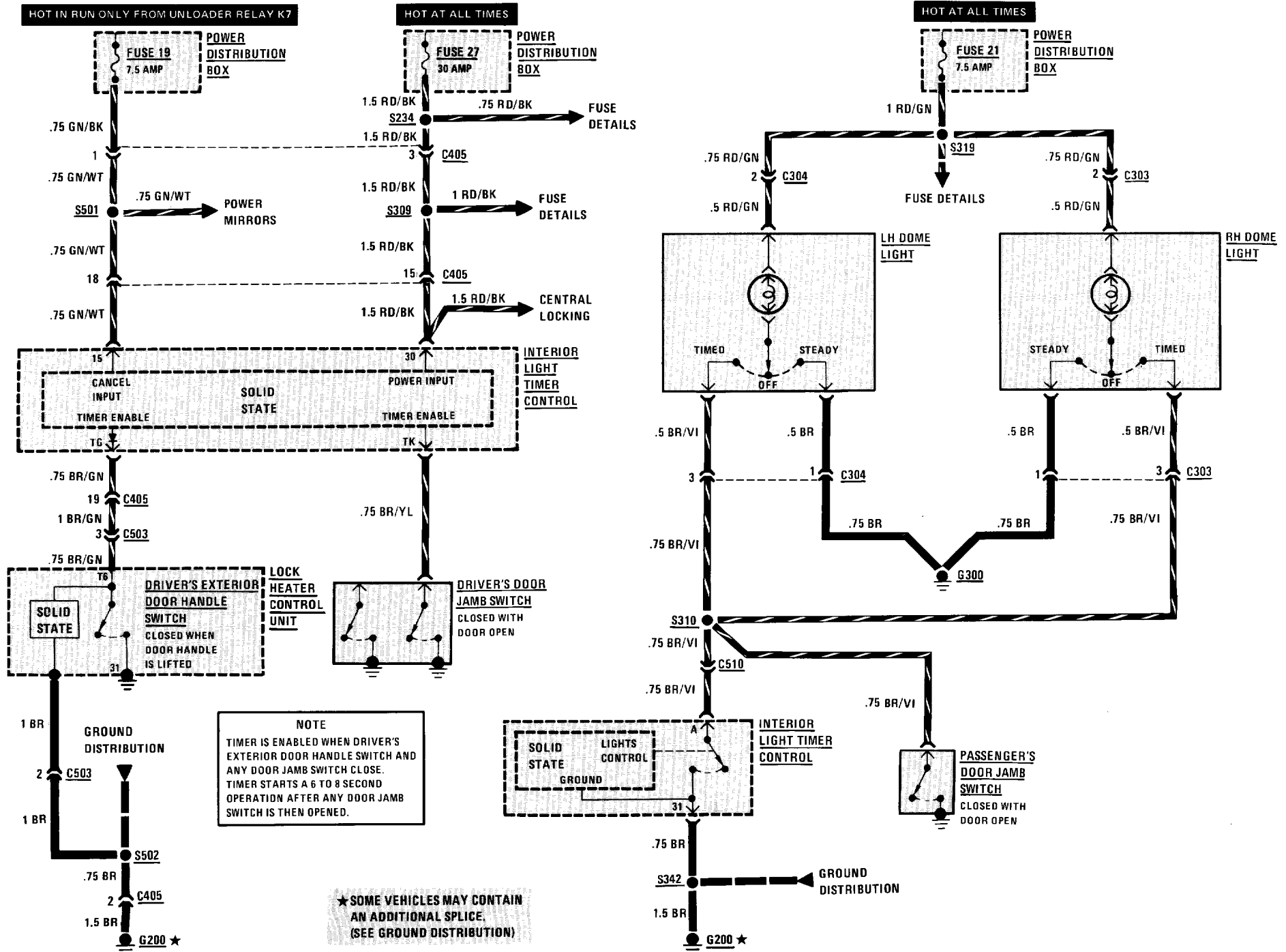

6410-0 HEATING AND AIR CONDITIONING

SYSTEM CHECK

This procedure provides an overall check of the Heating and Air Conditioning System. Each of the steps can be performed without disassembly or the use of tools.

Complete this procedure with the temperature outside the car above 60 degrees F (16 degrees C) and the engine warm and running at idle.

SYSTEM CHECK TABLE

SET: Temperature Control fully counterclockwise Upper and Lower Slide Levers to extreme left Center Slide Lever to extreme right Blower Speed Control at 0 (OFF)	
ACTION	NORMAL RESULT
Press Fresh/Recirculating Air Switch (ON). Release A/C button (OFF).	Fresh/Recirculating pushbutton lights. Blower runs slowly.
Rotate Blower Speed Control through steps 1 to 4	Blower speed increases at each step to maximum speed at Step 4
Press Fresh/Recirculating Air Switch to release it (OFF)	Fresh/Recirculating button is no longer lit. Outside air is drawn into car. (The sound of Flap Door Motors may be heard repositioning flaps.)
Rotate Temperature Control at least 1/4 turn clockwise	Air flow becomes warm
Depress A/C button (ON)	A/C button lights. A/C Compressor runs. Auxiliary Cooling Fan runs.
Press A/C button to release it (OFF)	A/C button is no longer lit. A/C Compressor turns off. Auxiliary Cooling Fan turns off.
Set Blower Speed Control to 0 (OFF)	Blower turns off

- If all of the steps can be completed as described, the Heating and Air Conditioning System is operating normally.

6411-0 A/C TEMPERATURE CONTROL

HEATING AND AIR CONDITIONING (HOT WATER CONTROL)

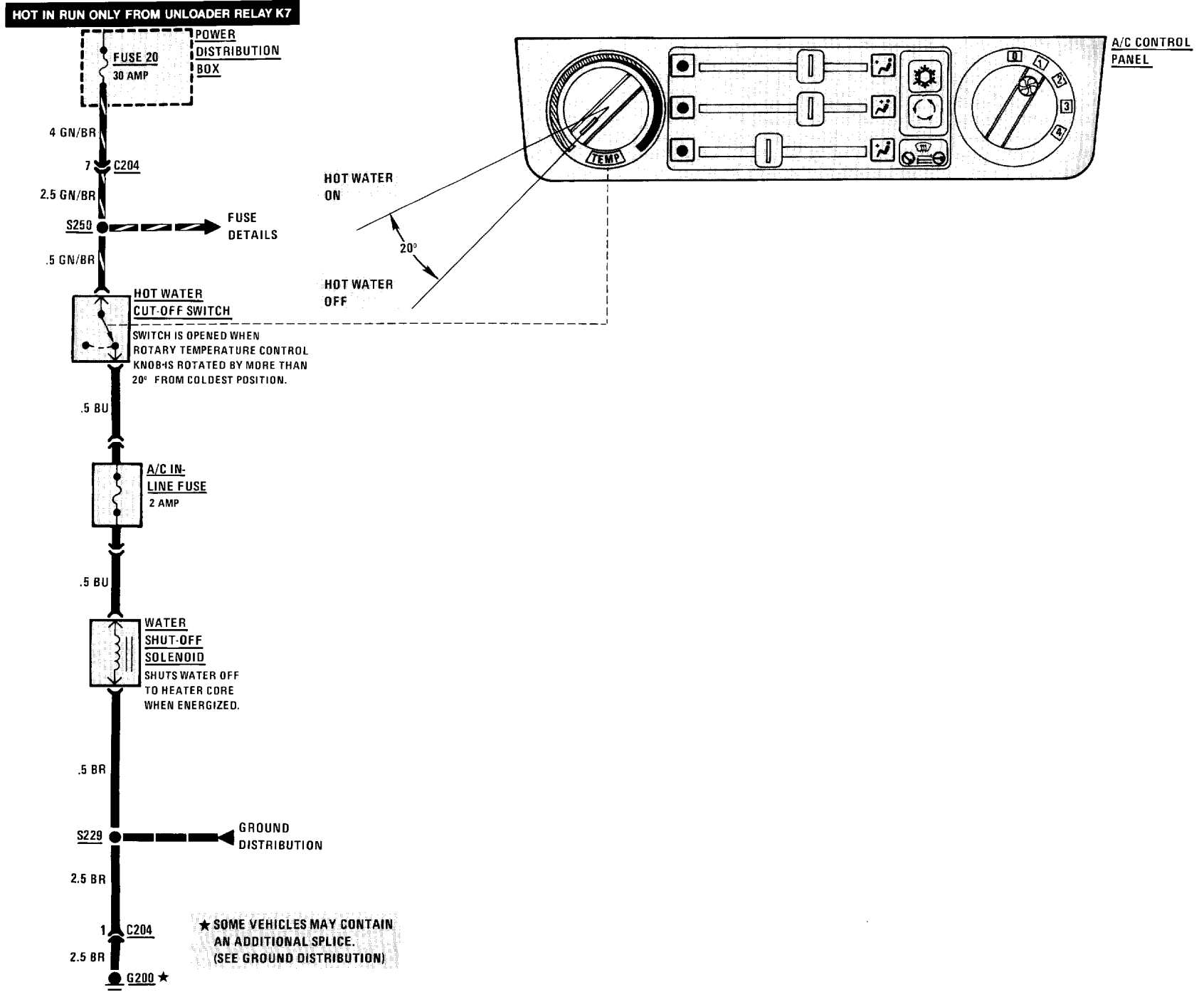

CIRCUIT OPERATION

The Water Shut-Off Solenoid controls the flow of engine coolant through the heater core. When the solenoid is energized, coolant flow is shut off to allow maximum cooling from the air conditioning system. The Water Shut-Off Solenoid is controlled by the Hot Water Cut-Off Switch, which is part of the A/C Control Panel TEMP Control.

Battery voltage is applied through Fuse 20 to the Hot Water Cut-Off Switch when the Ignition Switch is in RUN. The Hot Water Cut-Off Switch is closed when the TEMP Control is rotated fully counterclockwise (coldest position), and opens when the control is rotated more than 20 degrees in a clockwise direction. When the switch is closed, battery voltage is applied through the A/C In-Line Fuse to the Water Shut-Off Solenoid. The solenoid is energized and shuts off the coolant flow through the heater core.

The Water Shut-Off Solenoid and A/C In-Line Diode are protected by the A/C In-Line Fuse. If any failures occur in the solenoid, the fuse will isolate them to prevent the failures from affecting other parts of the heating and air conditioning circuits.

TROUBLESHOOTING HINTS

- Try the following checks before doing the System Diagnosis.
- 1. Check that Water Shut-Off Solenoid connector is firmly seated.
- 2. Check the A/C In-Line Fuse.
- Go to Heating and Air Conditioning (6410-0) System Check for a guide to normal operation.
- Go to System Diagnosis for diagnostic tests.

SYSTEM DIAGNOSIS

- Do the following test if the Water Shut-Off Solenoid does not operate normally.

WATER SHUT-OFF SOLENOID TEST (TABLE 1)

Measure: VOLTAGE At: WATER SHUT-OFF SOLENOID CONNECTOR (Disconnected) Conditions: <ul style="list-style-type: none"> • Ignition Switch: RUN • A/C Control Panel TEMP Control: FULLY COUNTERCLOCKWISE 		
Measure Between	Correct Voltage	For Diagnosis
BU & Ground	Battery	See 1
BU & or BR	Battery	See 2
<ul style="list-style-type: none"> • Rotate A/C Control Panel TEMP Control to Mid-Position 		
BU & Ground	0 Volts	See 3

(Continued in next column)

(Continued from previous column)

- If all voltages are correct, replace the Water Shut-Off Solenoid.
- 1. Check the BU wire and A/C In-Line Fuse for an open. If wire and fuse are good, go to Table 2.
- 2. Check the BR wire for an open to ground. Check that connector C204 is properly mated.
- 3. Check BU wire for a wire-to-wire short to voltage. If wire is good, replace the A/C Control Panel TEMP Control.

WATER SHUT-OFF SOLENOID TEST (TABLE 2)

Measure: VOLTAGE At: HOT WATER CUT-OFF SWITCH CONNECTOR (Disconnected) Conditions: <ul style="list-style-type: none"> • Ignition Switch: RUN • Water Shut-Off Solenoid: CONNECTED 		
Measure Between	Correct Voltage	For Diagnosis
GN/BR & Ground	Battery	See 1
GN/BR & BU	Battery	See 2
<ul style="list-style-type: none"> • If both voltages are correct, replace the A/C Control Panel TEMP Control. 1. Check the GN/BR wire for an open back to Fuse 20. 2. Check the BU wire for an open. 		

HEATING AND AIR CONDITIONING (BLOWER CONTROLS)

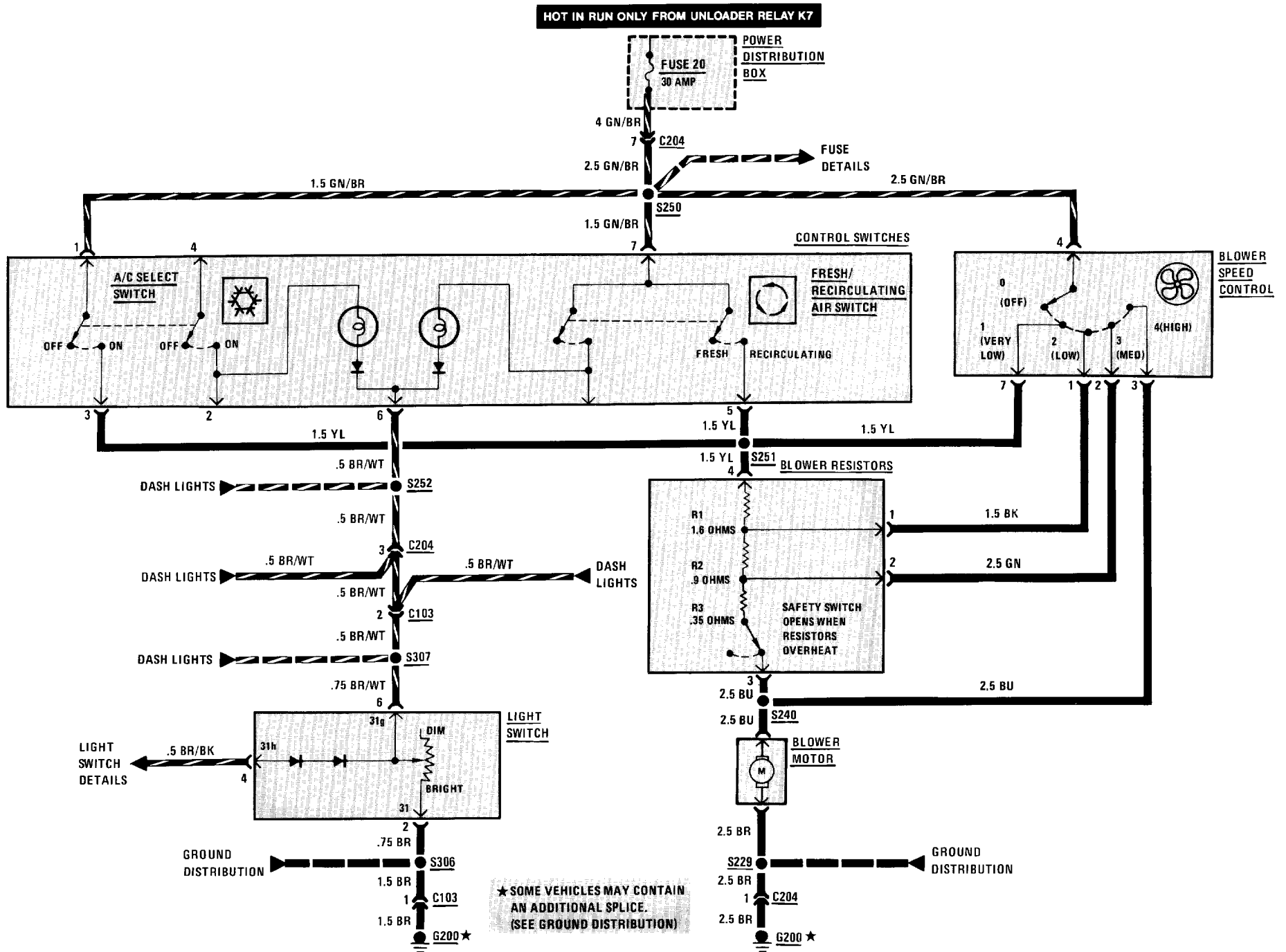

CIRCUIT OPERATION

With the Ignition Switch in RUN, battery voltage is applied to the Control Switches and the Blower Speed Control through the GN/BR wires. If either the A/C Select Switch or the Fresh/Recirculating Air Switch are ON or the Blower Speed Control is in position 1, battery voltage is applied through the YL wire to the Blower Resistors and the Blower Motor.

The Blower Motor is a variable speed motor which runs at a speed proportional to the voltage applied to it. With all of the Blower Resistors in the circuit, the voltage applied to the Motor is reduced so the Motor runs at a low speed.

As the Blower Speed Control is moved through positions 2 and 3, some of the Resistors are bypassed, allowing more voltage to be applied to the Blower Motor, which then runs at a higher speed. When the Blower Speed Control is moved to position 4, battery voltage is applied directly to the Blower Motor, which then runs at maximum speed.

The Blower Resistors dissipate heat because of the current flowing through them. They are cooled by the air flow from the Blower. If there is insufficient air flow to cool the Resistors, the Safety Switch will open, shutting the Blower Motor off until the Resistors have cooled.

TROUBLESHOOTING HINTS

- Try the following checks before doing the System Diagnosis.
 1. Check Fuse 20 by visual inspection.
 2. If Blower will run in high only, check the Blower Resistors' Safety Switch for an open.
- Go to Heating and Air Conditioning (6410-0) System Check for a guide to normal operation.
- Go to System Diagnosis for diagnostic tests.

SYSTEM DIAGNOSIS

- Do the tests listed for your symptom in the Symptom Table below.
- Tests follow the Symptom Table.

SYMPTOM TABLE

SYMPTOM	DO TEST
Blower Motor does not run in any speed setting.	B
Blower runs only in HIGH (does not run in any other speed setting).	B
Blower does not run in some modes.	A
Blower does not run with A/C ON or in Recirculating mode.	A
A/C Select Switch or Fresh/Recirculating Air Switch does not light.	A

A: CONTROL SWITCH VOLTAGE TEST

Measure: VOLTAGE		
At: CONTROL SWITCHES CONNECTOR (Disconnected)		
Conditions:		
<ul style="list-style-type: none"> • Ignition Switch: RUN • Blower Speed Control: OFF 		
Measure Between	Correct Voltage	For Diagnosis
1 (GN/BR) & Ground	Battery	See 1

(Continued in next column)

(Continued from previous column)

1 (GN/BR) & 3 (YL)	Battery	See 2 & 4
7 (GN/BR) & Ground	Battery	See 1
7 (GN/BR) & 5 (YL)	Battery	See 2 & 4
7 (GN/BR) & 6 (BR/WT)	Battery	See 3
<ul style="list-style-type: none"> • If all voltages are correct, do Test B. <ol style="list-style-type: none"> 1. Check the GN/BR wire for an open. 2. Check the YL wire for an open. 3. Check the BR/WT wire for an open. 4. If voltage is not present between the GN/BR wire and both the YL wires (terminals 3 and 5), do Test B. 		

B: BLOWER SPEED CONTROL TEST

Measure: VOLTAGE		
At: BLOWER SPEED CONTROL CONNECTOR (Disconnected)		
Conditions:		
<ul style="list-style-type: none"> • Ignition Switch: RUN • A/C Select Switch: ON (Depressed) • Fresh/Recirculating Air Switch: FRESH (Not Depressed) 		
Measure Between	Correct Voltage	For Diagnosis
4 (GN/BR) & Ground	Battery	See 1
7 (YL) & Ground	Battery	See 2
• A/C Select Switch: OFF (Not Depressed)		
7 (YL) & Ground	0 Volts	See 3

(Continued on next page)

6413-2 A/C BLOWER CONTROLS

(Continued from previous page)

4 (GN/BR) & 7 (YL)	Battery	See 4, 8, 9, & 10
4 (GN/BR) & 1 (BK)	Battery	See 5, 8, 9, & 10
4 (GN/BR) & 2 (GN)	Battery	See 6, 8, 9, & 10
4 (GN/BR) & 3 (BU)	Battery	See 7 & 10

- If all voltages are correct, replace the Blower Motor.

1. Check the GN/BR wire for an open.
2. Check the YL wire for an open between Blower Speed Control and splice S231.
3. Check the YL wire for a wire to wire short to voltage.
4. Check the YL wire for an open between splice S231 and the Blower Resistors.
5. Check the BK wire for an open.
6. Check the GN wire for an open.
7. Check the BU wire for an open.
8. If voltage is not present at the YL wire, but is present at the GN wire or BK wire, replace the Blower Resistors.
9. If voltage is not present at the YL, BK or GN wires, check for an open Blower Resistors' Safety Switch.
10. If voltage is not present at the YL, BK, GN and BU wires, do Test C.

C: BLOWER MOTOR TEST

Measure: VOLTAGE		
At: BLOWER MOTOR CONNECTOR		
(Disconnected)		
Conditions:		
• Ignition Switch: RUN		
• A/C Select Switch: ON		
• Blower Speed Control: HIGH		
Measure Between	Correct Voltage	For Diagnosis
BU & Ground	Battery	See 1
BU & BR	Battery	See 2

- If both voltages are correct, replace the Blower Motor.

1. Check the BU wire for an open. If wire is good, recheck Test B.
2. Check the BR wire to ground G200 for an open.

6421-0 A/C AIR DELIVERY CONTROL

HEATING AND AIR CONDITIONING (FRESH/RECIRCULATING AIR CONTROLS)

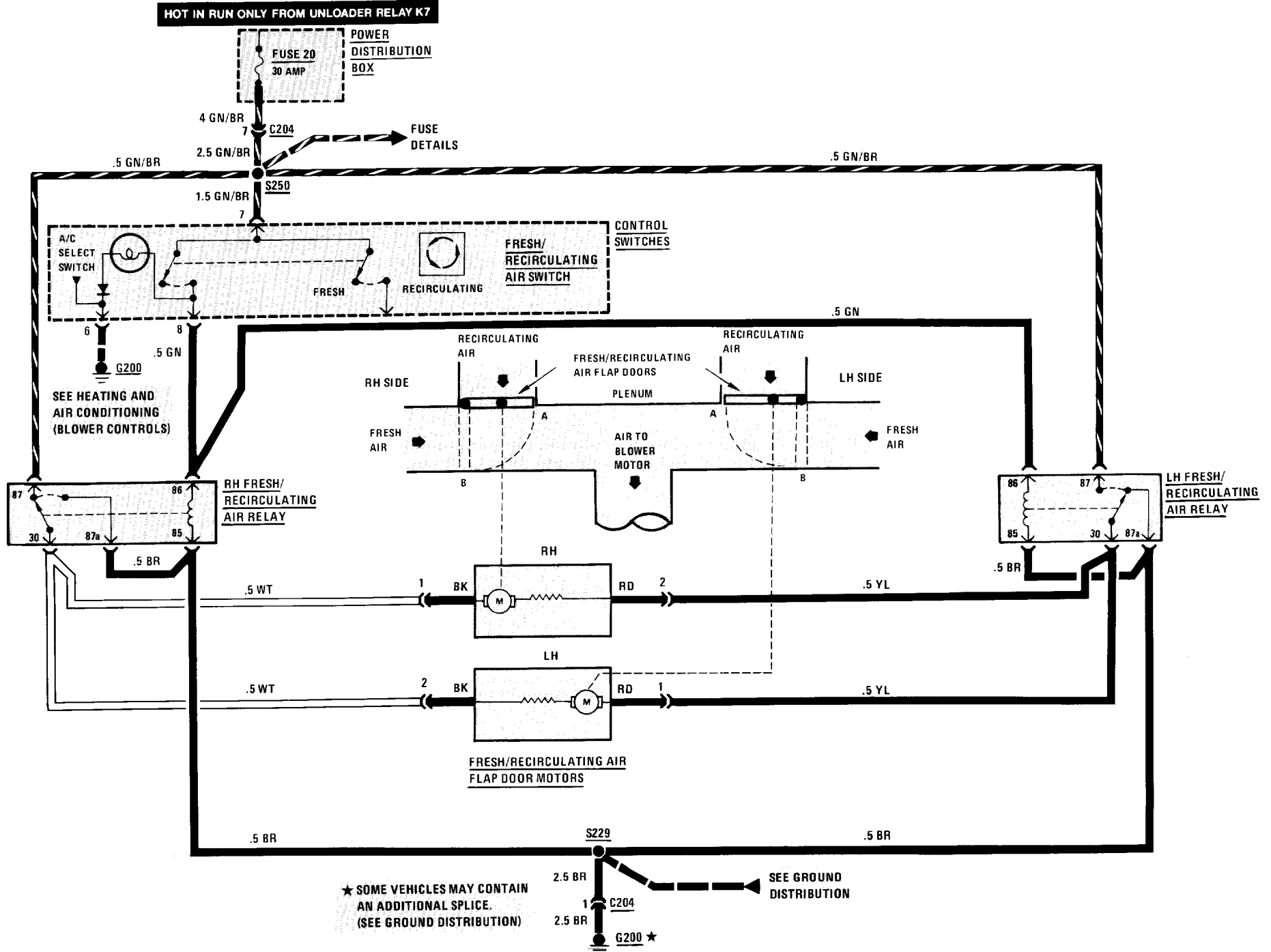

CIRCUIT OPERATION

When the Ignition Switch is in RUN, battery voltage is applied to terminal 7 of the Control Switches, the normally open contacts of the LH Fresh/Recirculating Air Relay, and the normally closed contacts of the RH Fresh/Recirculating Air Relay. If the Fresh/Recirculating Air Switch is not depressed (open), battery voltage is applied through the normally closed contacts of the RH Fresh/Recirculating Air Relay to both Fresh/Recirculating Air Flap Door Motors and then to ground through the normally closed contacts of the LH Fresh/Recirculating Air Relay. Both motors operate and move the Fresh/Recirculating Air Flap Doors to position A, allowing fresh air to enter the blower.

When the Fresh/Recirculating Air Switch is depressed (closed), battery voltage is applied through the switch to both the LH and RH Fresh/Recirculating Air Relay coils. Both relays are energized. Battery voltage is then applied through the closed contacts of the LH Fresh/Recirculating Air Relay to the Flap Door Motors, and to ground through the closed contacts of the RH Fresh/Recirculating Air Relay. Since the voltage is now applied to the Flap Door Motors in the opposite direction, the motors reverse direction and move the Fresh/Recirculating Air Flap Doors to position B, allowing only recirculating air to enter the blower. Both of the Air Flap Door Motors remain energized continuously. When the doors reach the end of their travel, the motors stall and hold the doors in position.

TROUBLESHOOTING HINTS

- Try the following checks before doing the System Diagnosis.
- 1. Check that LH and RH Fresh/Recirculating Air Relays are firmly seated.
- 2. Check that LH and RH Fresh/Recirculating Air Relay pigtail connectors are properly mated.
- Go to Heating and Air Conditioning (6410-0) System Check for a guide to normal operation.
- Go to System Diagnosis for diagnostic tests.

SYSTEM DIAGNOSIS

- Do the tests below if the Fresh/Recirculating Air Flap Doors do not operate.

A: FRESH/RECIRCULATING AIR FLAP DOOR MOTOR VOLTAGE TEST

Measure: VOLTAGE At: FRESH/RECIRCULATING AIR FLAP DOOR MOTOR PIGTAIL CONNECTORS (Disconnected) Conditions: <ul style="list-style-type: none"> • Ignition Switch: RUN • Fresh/Recirculating Air Switch: RELEASED (FRESH) 		
Measure Between	Correct Voltage	For Diagnosis
WT and Ground	Battery	See 1
WT and YL	Battery	See 2
<ul style="list-style-type: none"> • Fresh/Recirculating Air Switch: DEPRESSED (RECIRCULATING) 		
YL and Ground	Battery	See 3

(Continued in next column)

(Continued from previous column)

YL and WT	Battery	See 3
<ul style="list-style-type: none"> • If all voltages are correct, replace the inoperative motor. 1. Check the WT wire for an open. If wire is good, do Test B for RH Air Relay. 2. Check the YL wire for an open. If wire is good, do Test B for LH Air Relay. 3. Do Test B for both Air Relays. 		

B: FRESH/RECIRCULATING AIR RELAY VOLTAGE TEST

Measure: VOLTAGE At: FRESH/RECIRCULATING AIR RELAY CONNECTOR (Disconnected) Conditions: <ul style="list-style-type: none"> • Ignition Switch: RUN • Fresh/Recirculating Air Switch: DEPRESSED (RECIRCULATING) • Fresh/Recirculating Air Flap Door Motor Connectors: CONNECTED 		
Measure Between	Correct Voltage	For Diagnosis
87 (GN/BR) and Ground	Battery	See 1
86 (GN) and Ground	Battery	See 2
86 (GN) and 85 (BR)	Battery	See 3
86 (GN) and 87a (BR)	Battery	See 3

(Continued on next page)

6421-2 A/C AIR DELIVERY CONTROL

(Continued from previous page)

- If all voltages are correct, replace the suspect Fresh/Recirculating Air Relay.
- 1. Check the GN/BR wire for an open.
- 2. Check the GN wire back to the Control Switches for an open. If wire is good, do Test C.
- 3. Check the BR wire for an open.

C: CONTROL SWITCHES VOLTAGE TEST

Measure: VOLTAGE

**At: CONTROL SWITCHES CONNECTOR
(Disconnected)**

Condition:

- Ignition Switch: RUN

Measure Between	Correct Voltage	For Diagnosis
7 (GN/BR) & Ground	Battery	See 1
7 (GN/BR) & 8 (GN)	Battery	See 2

- If both voltages are correct, replace the Control Switches.
- 1. Check the GN/BR wire for an open. If wire is good, check that connector C204 is properly mated.
- 2. Check the GN wire for an open between the Control Switches and the LH and RH Fresh/Recirculating Air Relays.

6452-0 A/C COMPRESSOR CONTROLS

HEATING AND AIR CONDITIONING (COMPRESSOR CONTROLS)

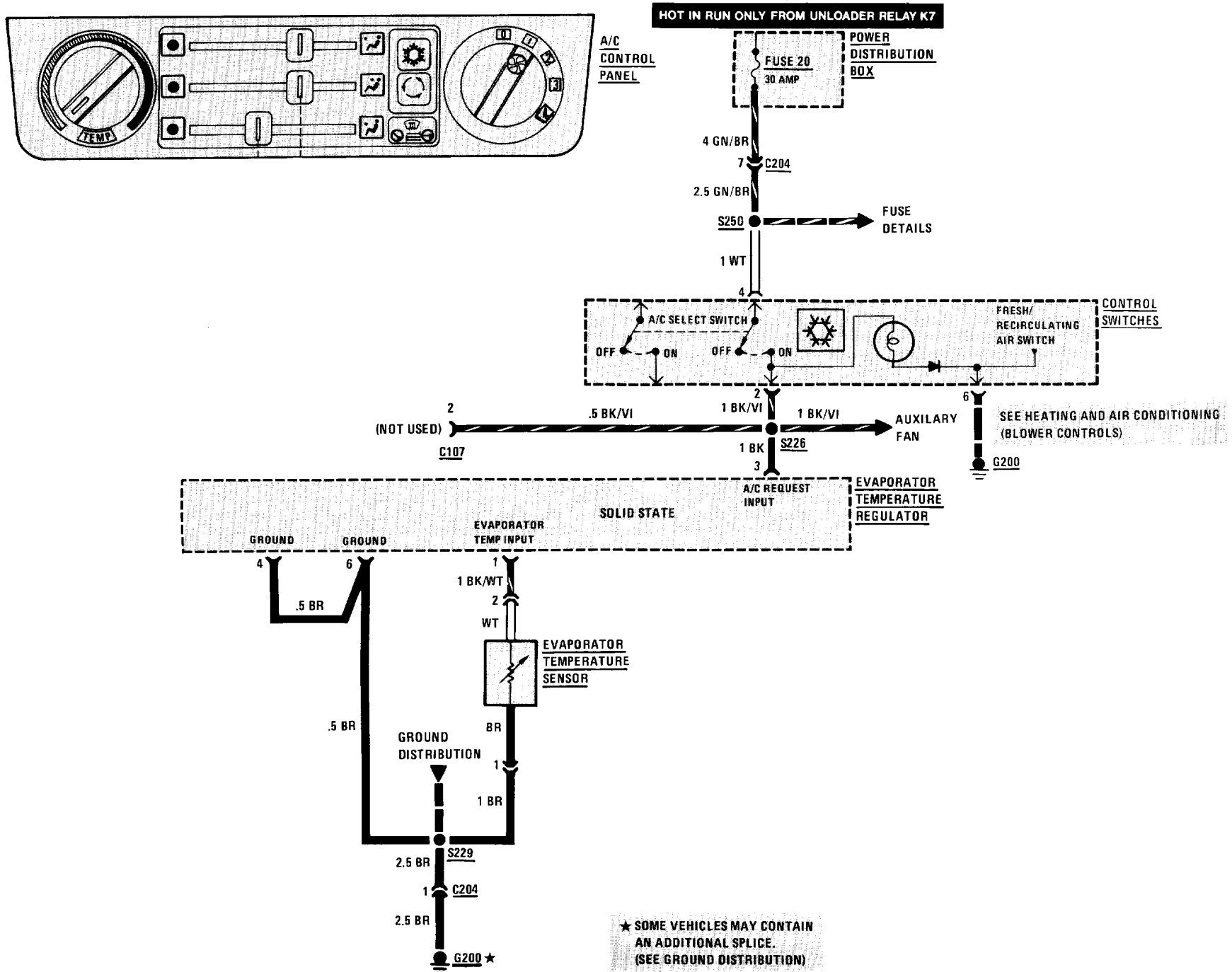

HEATING AND AIR CONDITIONING (COMPRESSOR CONTROLS)

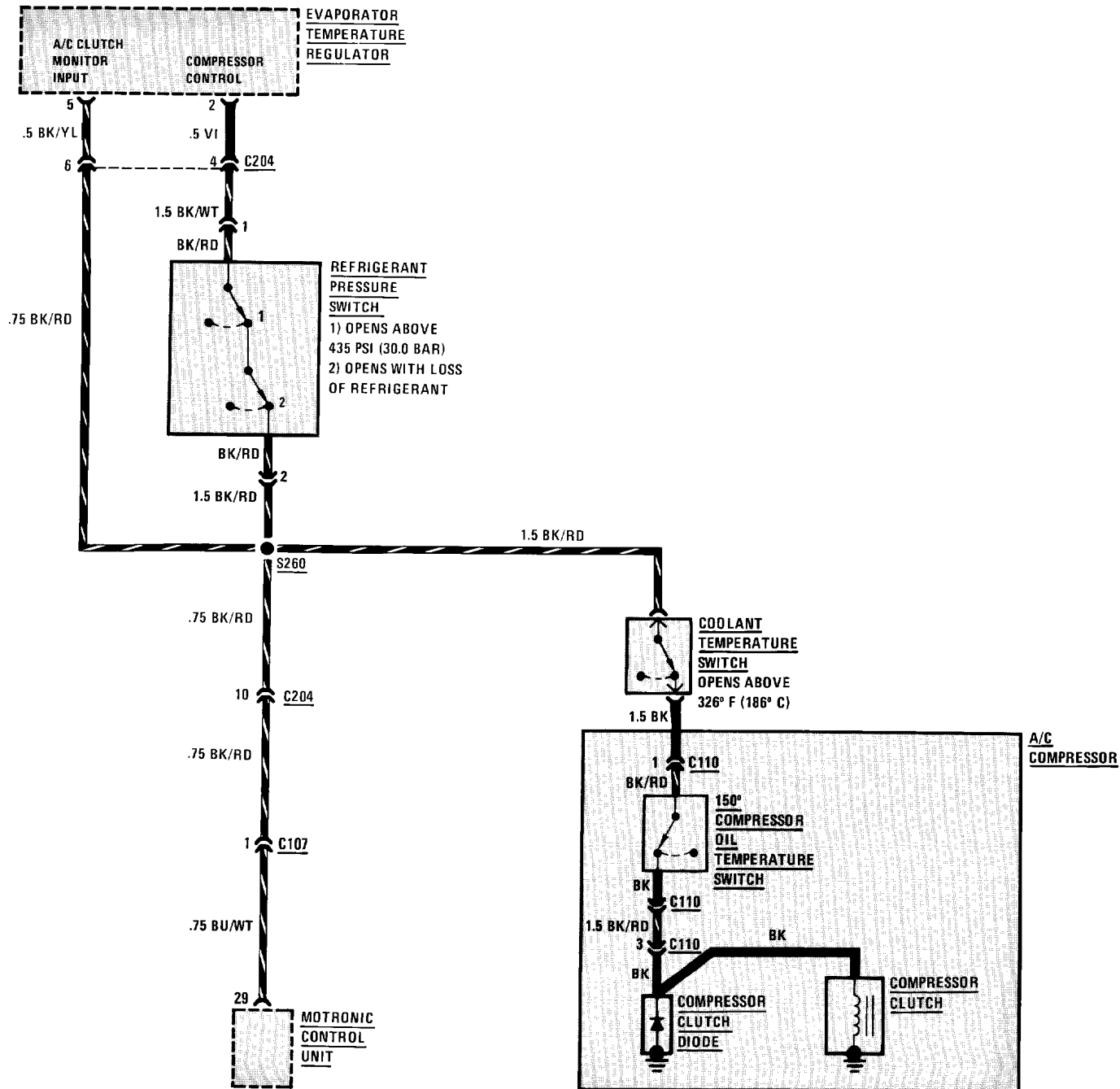

CIRCUIT OPERATION

When the Ignition Switch is in RUN, battery voltage is applied through Fuse 20 to the A/C Select Switch. When the A/C Select Switch is pressed, voltage is applied to terminal 3 of the Evaporator Temperature Regulator. The Evaporator Temperature Regulator applies voltage from terminal 2 to the Compressor Clutch through the Refrigerant Pressure Switch and the Temperature Switch.

The Refrigerant Pressure Switch will disengage the Compressor Clutch when refrigerant pressure rises above 435 PSI (30.0 Bar), or when a loss of refrigerant brings the pressure below 21.8 PSI (1.5 Bar). The Evaporator Temperature Regulator will detect the Refrigerant Pressure Switch opening at terminal 5 and will turn off the output voltage at the Compressor Control terminal. The Evaporator Temperature Regulator will not allow the Compressor Clutch to be turned on again until circuit continuity has been restored between terminals 5 and 2. The regulator tests for continuity by momentarily applying voltage at the Compressor Control every 8 to 10 seconds. Voltage at the A/C Clutch Monitor Input indicates continuity. The Evaporator Temperature Regulator will continue to apply voltage at the Compressor Control output, which will energize the Compressor.

The Temperature Switch opens to remove the compressor load from the engine if the engine coolant temperature rises above 226 °F (108 °C). The Evaporator Temperature Sensor signals the Evaporator Temperature Regulator to de-energize the Compressor Clutch when evaporator temperature is low enough for freezing to result.

Clutch Diode

Whenever the Compressor Clutch is de-energized, the collapsing magnetic field induces a voltage in the winding. The Clutch Diode provides a path for the resulting current.

A/C On Input

When the Compressor Clutch is turned on, voltage is applied to terminal 29 of the Motronic Control Unit. The Motronic Control Unit uses this signal increase idle speed to compensate for the increased engine load from the Compressor Clutch engaging.

TROUBLESHOOTING HINTS

- Try the following checks before doing the System Diagnosis.
 1. Check Fuse 20 by visual inspection.
 2. Check that Compressor Clutch connector is firmly seated.
- Go to Heating and Air Conditioning (6410A-0) System Check for a guide to normal operation.
- Go to System Diagnosis for diagnostic tests.

SYSTEM DIAGNOSIS

- Do the tests listed for your symptom in the Symptom Table below.
- Tests follow the Symptom Table.

SYMPTOM TABLE

Compressor Clutch does not engage	A
Engine idle speed is not high enough when Compressor Clutch engages (325 engine only)	D

A: A/C ISOLATION TEST (TABLE 1)

Measure: VOLTAGE At: EVAPORATOR TEMPERATURE REGULATOR (Disconnected) Conditions: • Ignition Switch: RUN (Engine need not be running) • A/C Selector Switch: ON (Depressed)		
Measure Between	Correct Voltage	For Diagnosis
3 & Ground	Battery	See 1
• If voltage is correct, go to Table 2. 1. Go to Test E.		

A: A/C ISOLATION TEST (TABLE 2)

Connect: FUSED JUMPER At: EVAPORATOR TEMPERATURE REGULATOR (Disconnected) Conditions: <ul style="list-style-type: none"> • Ignition Switch: RUN • A/C Selector Switch: ON (Depressed) 		
Connect Across	Correct Result	For Diagnosis
2 & 3	Compressor Clutch Engages	See 1
<ul style="list-style-type: none"> • If result is correct go to Test C. 1. Go to Test B. 		

B: PRESSURE SWITCH TEST

Measure: RESISTANCE At: EVAPORATOR TEMPERATURE REGULATOR CONNECTOR (Disconnected) Conditions: <ul style="list-style-type: none"> • Ignition Switch: OFF • Negative Battery Terminal: DISCONNECTED 		
Measure Between	Correct Resistance	For Diagnosis
2 & Ground	Approximately 3 to 4 ohms	See 1
<ul style="list-style-type: none"> • If measurement is correct replace the Evaporator Temperature Regulator. 1. Check for an open Refrigerant Pressure Switch, A/C Temperature Switch, or associated wiring (see schematic). If Refrigerant Pressure Switch is open, check refrigerant pressure to be sure it is normal before replacing the switch. If the switches and related wiring are OK, replace the Compressor Clutch. 		

C: EVAPORATOR TEMPERATURE REGULATOR VOLTAGE AND RESISTANCE TEST

Measure: RESISTANCE At: EVAPORATOR TEMPERATURE REGULATOR CONNECTOR (Disconnected) Conditions: <ul style="list-style-type: none"> • Ignition Switch: OFF • Negative Battery Terminal: DISCONNECTED 		
Measure Between	Correct Resistance	For Diagnosis
1 & Ground	Approximately 3.5K to 4.5K ohms at 70 °F (21 °C)	See 1
4 & Ground	Less than 0.5 ohms	See 2
6 & Ground	Less than 0.5 ohms	See 2
5 & 2	Less than 0.5 ohms	See 3
<ul style="list-style-type: none"> • If all resistances are correct but Compressor Clutch does not operate normally, replace the Evaporator Temperature Regulator. 1. Check the BK/WT wire for an open or a short to ground (see schematic). Check the BR wire for an open (see schematic). If wires are good, replace the Evaporator Temperature Sensor. 2. Check the BR wire for an open (see schematic). 3. Check BK/RD for an open between terminal 5 and the Refrigerant Pressure Switch. 		

D: IDLE SPEED CONTROL VOLTAGE TEST

Measure: VOLTAGE At: MOTRONIC CONTROL UNIT CONNECTOR (Connected – Universal Adapter) Conditions: <ul style="list-style-type: none"> • Ignition Switch: RUN • A/C Control Panel: A/C ON • Temperature Outside Car: Above 60 degrees F (16 degrees C) 		
Measure Between	Correct Voltage	For Diagnosis
29 BL/WT & Ground	Battery	See 1
<ul style="list-style-type: none"> • If the voltage is correct, repair/replace the Motronic Control Unit. <ol style="list-style-type: none"> 1. Check for an open in the BL/WT and BK/RD wires. 		

E: A/C SELECT SWITCH VOLTAGE TEST

Measure: VOLTAGE At: CONTROL SWITCHES CONNECTOR (Connected) Conditions: <ul style="list-style-type: none"> • Ignition Switch: RUN • A/C Control Panel: A/C ON • Temperature Outside Car: Above 60 degrees F (16 degrees C) 		
Measure Between	Correct Voltage	For Diagnosis
4 (WT) & Ground	Battery	See 1
2 (BK/VI) & Ground	Battery	See 2
<ul style="list-style-type: none"> • If both voltages are correct, check connections at Evaporator Temperature Regulator. <ol style="list-style-type: none"> 1. Check for an open in the WT and GN/BR wires. 2. Replace the A/C Select Switch. 		

6454-0 AUXILIARY FAN

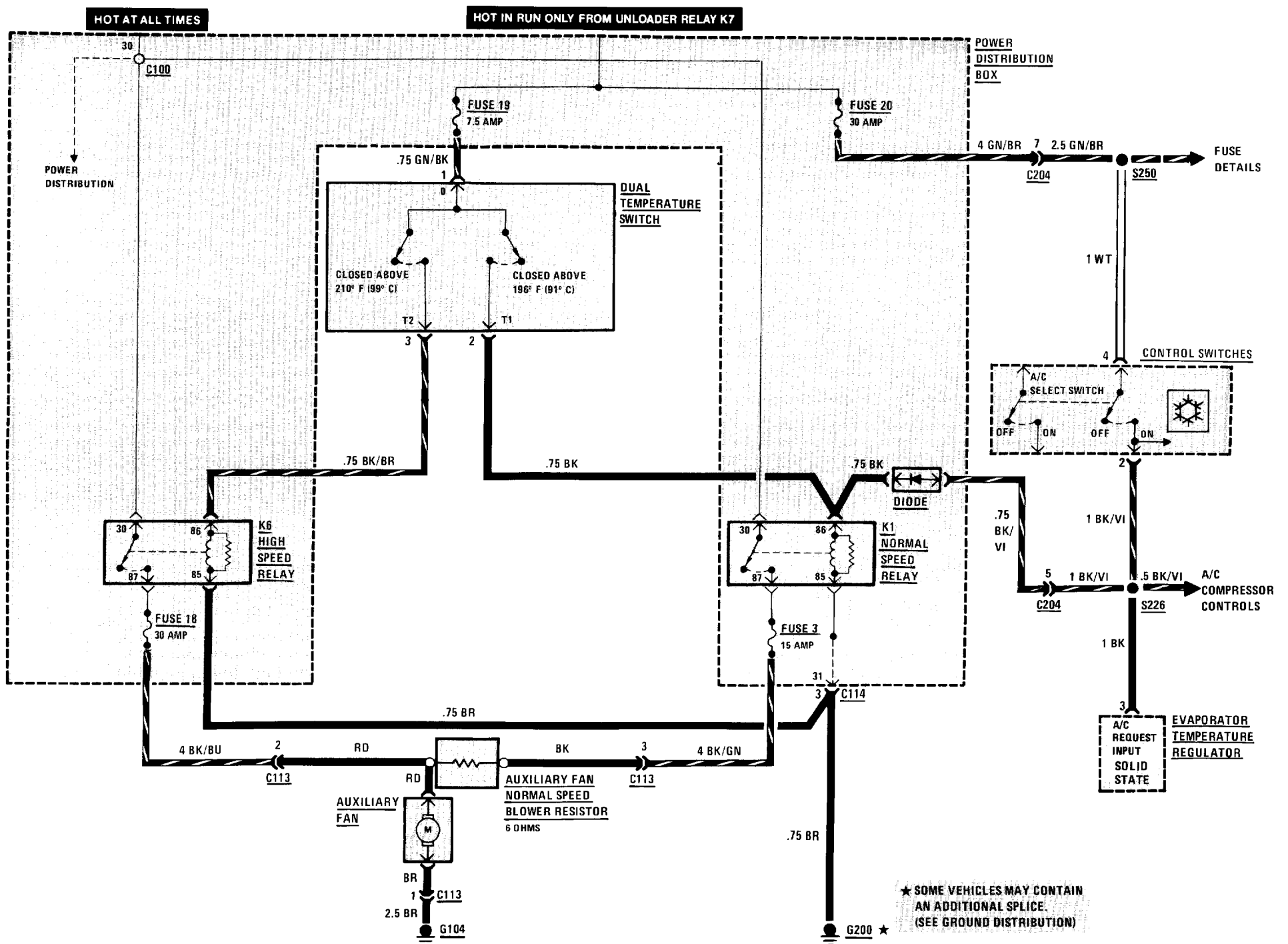

6500-0 RADIO/ANTENNA

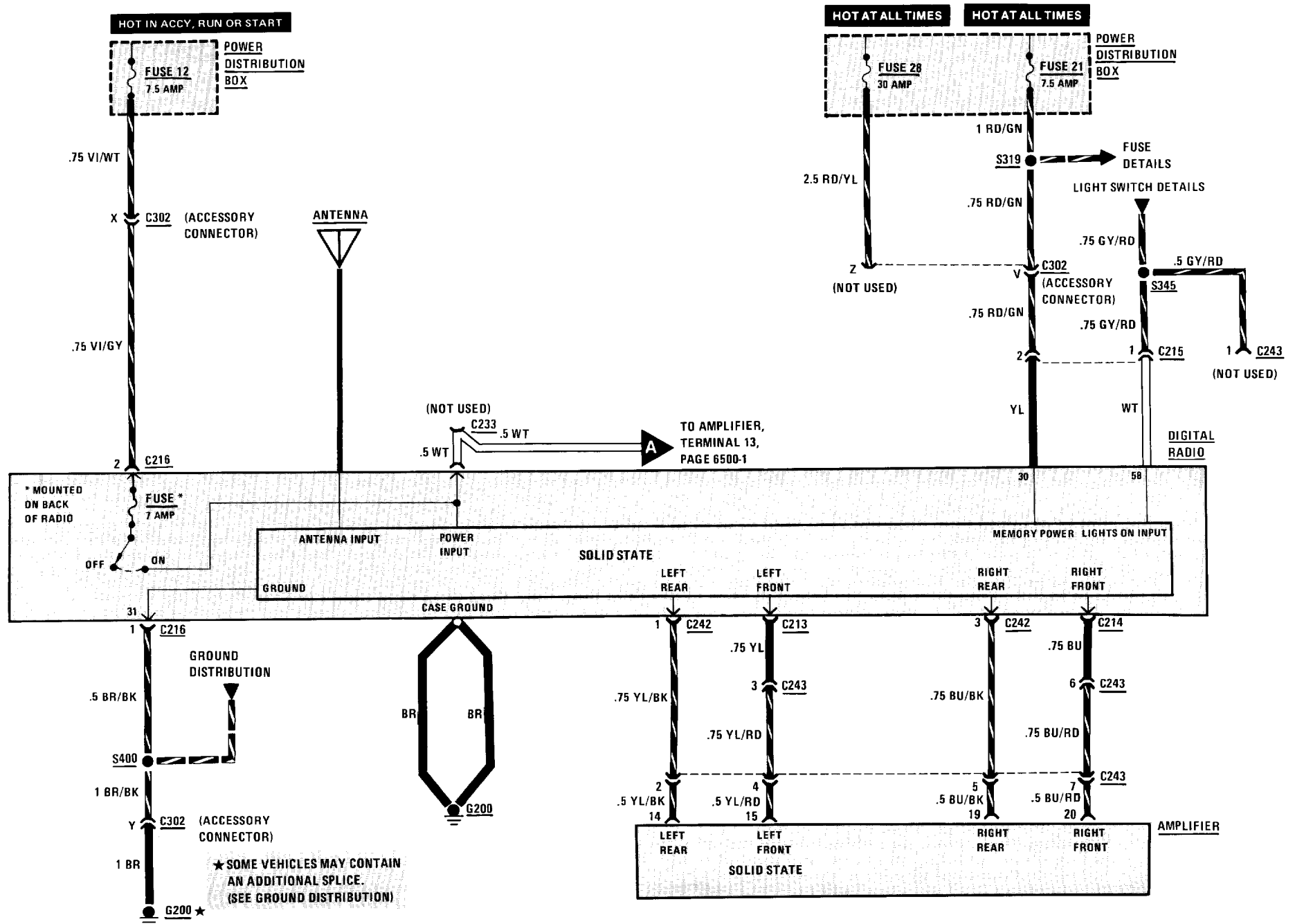

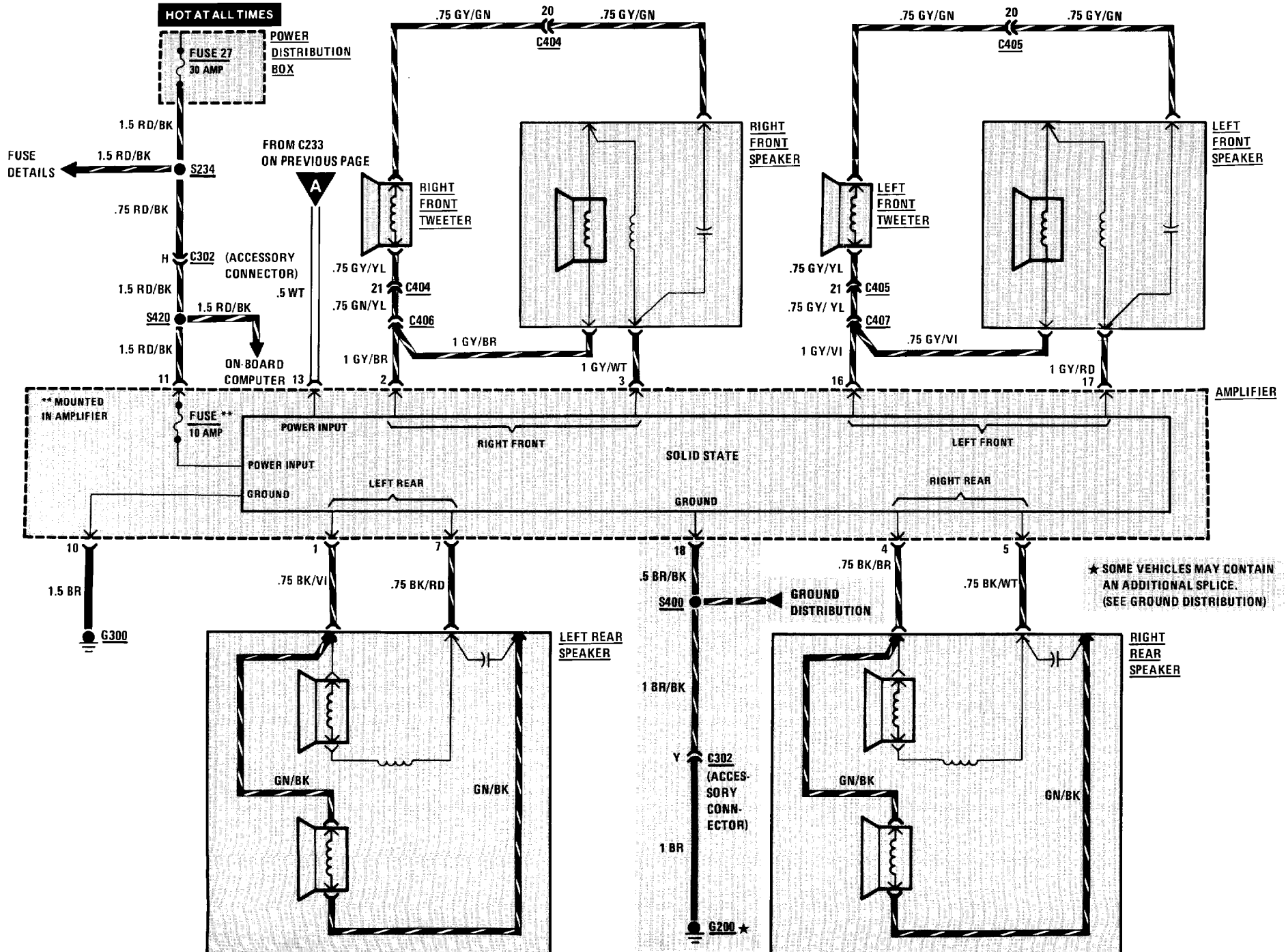

6500A-0 RADIO/ANTENNA

CIRCUIT OPERATION

With the Ignition Switch in ACCY, RUN or START, Fuse 12 provides voltage to turn on the three components in the system. When the Radio Switch is on, voltage is applied to the Radio and the Amplifier. This voltage is used to control the individual unit's main power supply.

Fuse 21 constantly supplies voltage to the Memory Power Input of the Radio. This allows the Radio to maintain the present settings while it is turned off.

The Amplifier receives constant power at terminal 11 from Fuse 27. When the Radio is on, voltage is applied to terminal 13 to enable the Amplifier.

The actual Radio signal originates at the Antenna. It is supplied to the Radio, processed, and output from the Left Channel and Right Channel Outputs. The signal is then input to the Left Front, Left Rear, Right Front and Right Rear Inputs to the Amplifier. After amplification, the signal is output to the corresponding speakers.

TROUBLESHOOTING HINTS

- Try the following checks before doing the System Check.
1. Check power input to the Radio by observing if Instrument Cluster Indicators light.
 2. Check memory power to Radio by checking operation of the Glove Box Light.
 3. Check power input to the Amplifier.
 4. Check that the Antenna is properly connected.
 5. Before troubleshooting a suspect Speaker, check all connections to that Speaker.
 6. If display shows "CODE" and Radio will not operate, the individual Anti-Theft Code must be entered. Refer to "Anti-Theft" instruction booklet.
 7. Check Radio Fuse located on back of Radio.
 8. Check Amplifier Fuse located on back of Amplifier.
 9. For Radio without Sound System: If a speaker is inoperative, switch with a good speaker. If still inoperative, check related wiring. Remove Radio for service if wiring is OK.

SYSTEM CHECK

- Use the System Check Table as a guide to normal operation.
- Refer to System Diagnosis for a list of symptoms and diagnostic steps.

SYSTEM CHECK TABLE

ACTION	NORMAL RESULT
With Ignition Switch in RUN, turn Radio ON.	Digital display lights. Sound is emitted from all Speakers.
Operate Fader Control.	Sound volume varies from front to rear.

- Refer to System Diagnosis when a result is not normal.

SYSTEM DIAGNOSIS

- Do the tests listed for your symptom in the Symptom Table below.
- Tests follow the Symptom Table.

SYMPTOM TABLE

SYMPTOM	FOR DIAGNOSIS
Radio does not work (no display, no sound).	Do Test A
Digital display lights, but there is no sound.	Do Test B
LH Speakers or RH Speakers do not operate.	Do Test C

(Continued on next page)

(Continued from previous page)

An individual Speaker does not operate.	Do Test D
Excessive noise comes from all speakers.	Do Test E

A: RADIO POWER TEST

Measure: VOLTAGE At: RADIO CONNECTOR C216 (Disconnected) or CONNECTOR C215 (Disconnected) Condition: • Ignition Switch: RUN		
Measure Between	Correct Voltage	For Diagnosis
C216 Ground	Battery	See 1
C216/2 & C216/1	Battery	See 2
C215/2 & Ground	Battery	See 3
• If all voltages are correct, check wire from connector C215 to Radio for an open. If wire is OK, remove Radio for service.		
1. Check power input wire for an open.		
2. Check ground wire for an open to ground. Make sure ground G200 is clean and tight.		
3. Check memory power supply wire for an open.		

B: AMPLIFIER POWER TEST

Measure: VOLTAGE At: AMPLIFIER CONNECTOR (Disconnected) Conditions: • Ignition Switch: RUN • Radio: ON		
Measure Between	Correct Voltage	For Diagnosis
11 & Ground	Battery	See 1
11 & 18	Battery	See 2
13 & Ground	Battery	See 3
11 & 10	Battery	See 4
• If all voltages are correct, go to Test C.		
1. Check power supply wire for an open.		
2. Check Amplifier ground to Amplifier for an open to ground. Make sure ground G200 is clean and tight.		
3. Check Amplifier "Radio On" wire for an open.		
4. Check wire from terminal 10 for an open to ground. Make sure ground G106 is clean and tight.		

C: FADER SIGNAL TEST (WITH SOUND SYSTEM)

Measure: VOLTAGE At: AMPLIFIER CONNECTOR (Disconnected) Conditions: • Ignition Switch: RUN • Radio: ON		
Measure Between	Correct Voltage	For Diagnosis
14 & Ground	Approximately 6 Volts	See 1
15 & Ground	Approximately 6 Volts	See 1
19 & Ground	Approximately 6 Volts	See 1
20 & Ground	Approximately 6 Volts	See 1
• If all voltages are correct but sound was not present, remove Amplifier for service.		
1. Check between Radio and Amplifier for an open in the wiring. If wire is OK, remove Radio for service.		

6500A-2 RADIO/ANTENNA

D: SUSPECT SPEAKER TEST

Connect: OHMMETER At: SUSPECT SPEAKER (Disconnected) <ul style="list-style-type: none"> • Ohmmeter set on Rx 1 scale or Diode Check Scale 		
Action	Correct Result	For Diagnosis
Connect Ohmmeter across Speaker Terminals	Speaker "pops"	See 1
<ul style="list-style-type: none"> • If the result is correct, check wires to the Amplifier or Radio for opens or shorts. If OK, check wires between Amplifier (if equipped) and the Radio. Remove Radio for service. <ol style="list-style-type: none"> 1. Replace the suspect Speaker. 		

E: NOISE DIAGNOSIS

With Radio on and noise present, unplug the Antenna at the back of the Radio.

- If noise is no longer present, it was being picked up by the Antenna. Perform Antenna Noise Test.
- If noise persists, it is coming in the Radio wiring. Refer to the following Noise Symptom Table.

ANTENNA NOISE TEST

Measure: RESISTANCE At: ANTENNA		
Measure Between	Correct Resistance	For Diagnosis
Antenna Plug Base & Ground	Less than 3 Ohms	See 1
Antenna Plug Tip & Antenna Plug Base	Greater than 1 Megaohm (open circuit)	See 2
<ul style="list-style-type: none"> • If both resistances are correct, check the hood ground strap. If OK, substitute different Antenna at Radio. If good, replace Antenna. If noise is still present, refer to Noise Symptom Table. <ol style="list-style-type: none"> 1. Check ground contact at Antenna base. If necessary, install a braided ground strap from the Antenna Base to Chassis ground. Check for an open in the Antenna Cable. 2. Check for a short to ground at the Antenna or Antenna cable. 		

NOISE SYMPTOM TABLE

SYMPTOM	POSSIBLE CAUSE	REPAIR ACTION
Harsh popping or crackling noise present when ignition on-changes with engine rpm.	Ignition Noise	<ul style="list-style-type: none"> • Check for proper distributor cap shielding. • Check shielding ground strap. If not present, install. • Check for defective spark plug or spark plug wire. • Reroute spark plug wires laying against anything that could be transmitting noise to the Radio (wiring or sensor leads traveling into the passenger compartment). • Check engine/firewall ground strap and engine hood/body ground strap. • Check if engine hood is closing properly. • Connect dedicated ground strap to Radio. • Replace distributor cap and rotor.
High whine or howling that changes with engine rpm.	Alternator noise	<ul style="list-style-type: none"> • Connect dedicated ground strap to Radio. • Run a direct wire from Battery to Alternator.
AM only is weak and noisy.	AM alignment	<ul style="list-style-type: none"> • Remove Radio for service.
FM only is weak and noisy.	FM alignment	<ul style="list-style-type: none"> • Remove Radio for service.

6571-0 CRUISE CONTROL

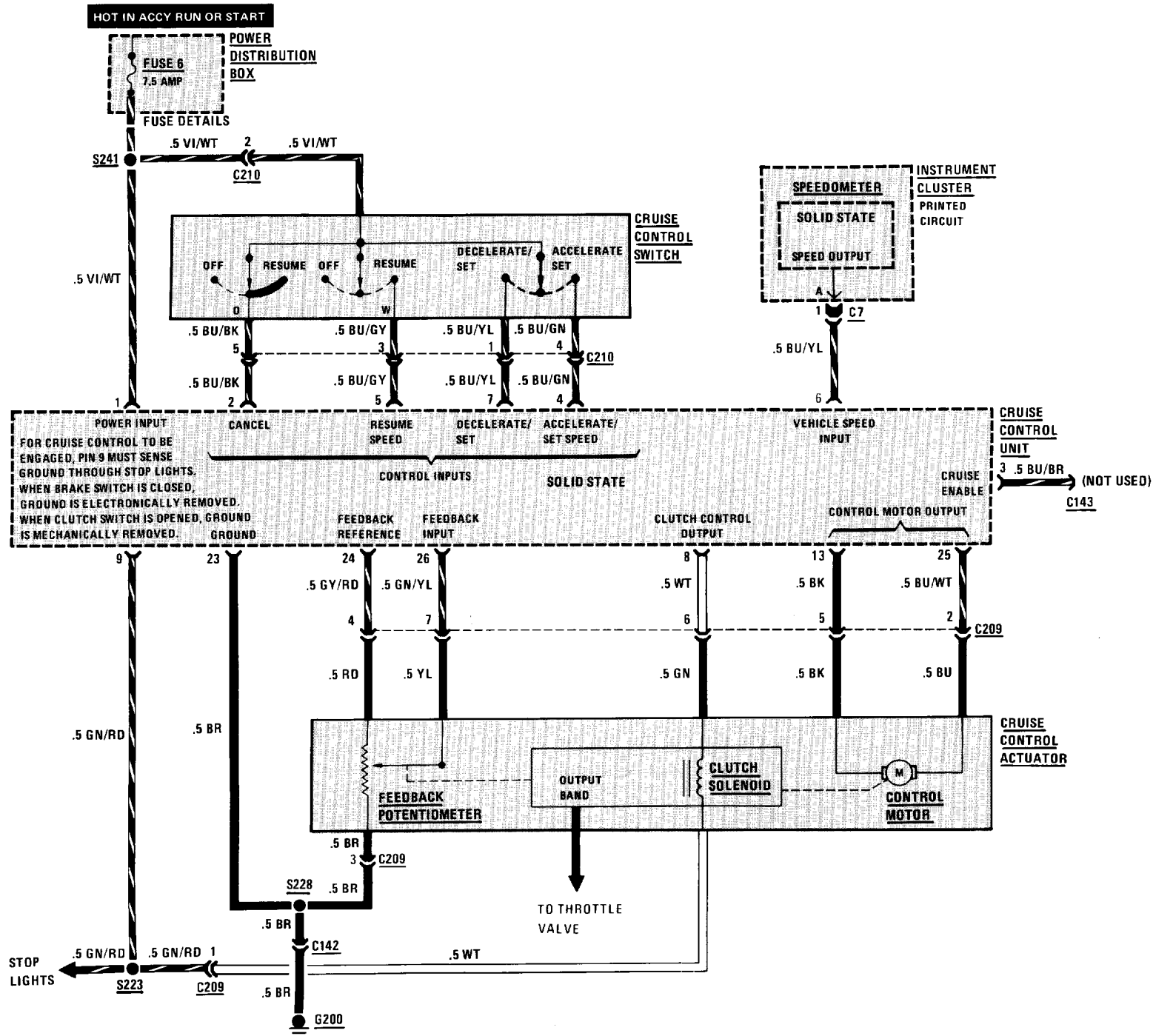

7000-0 COMPONENT LOCATION VIEWS

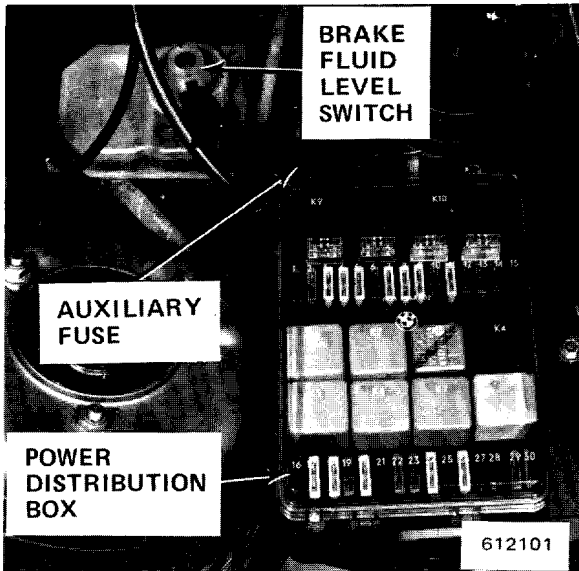

Figure 1 - LH Rear Corner of Engine Compartment

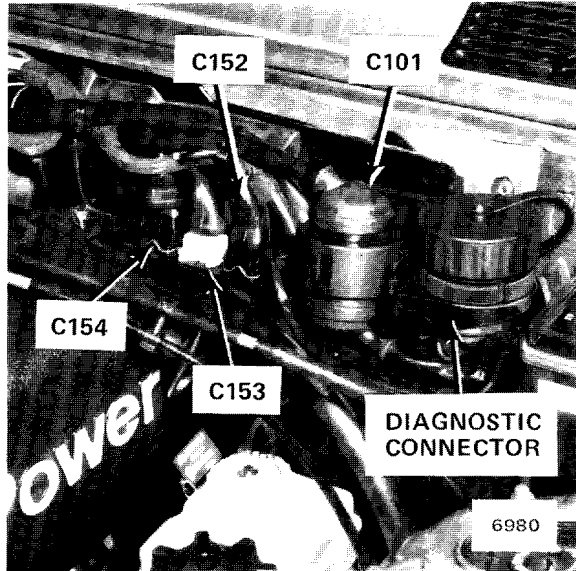

Figure 3 - LH Rear of Engine Compartment

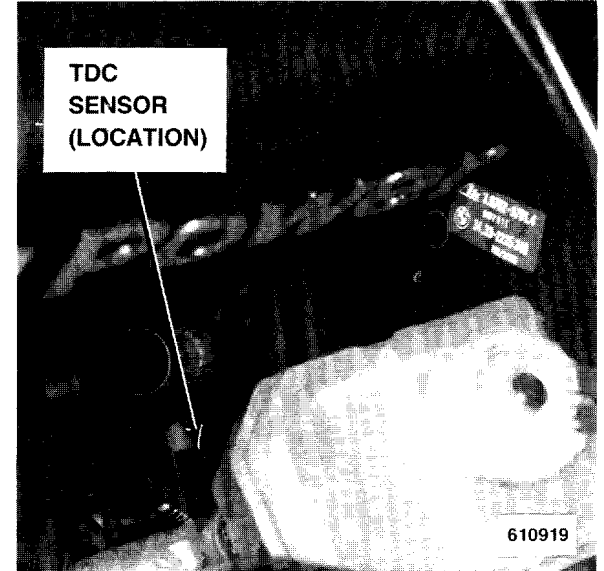

Figure 5 - Lower LH Rear of Engine

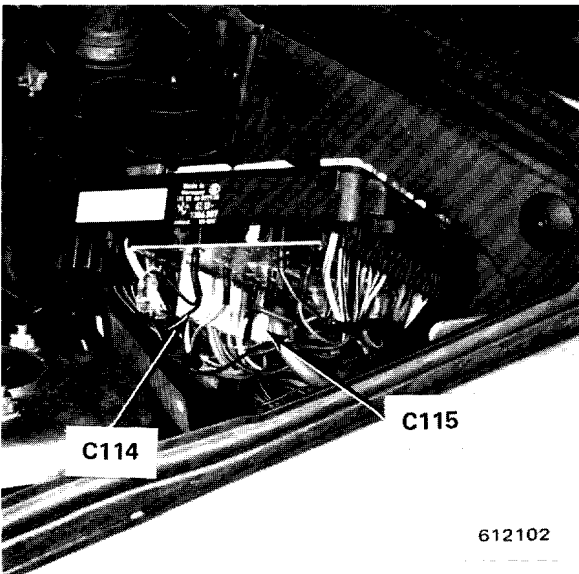

Figure 2 - LH Rear Corner of Engine Compartment (Inside Power Distribution Box)

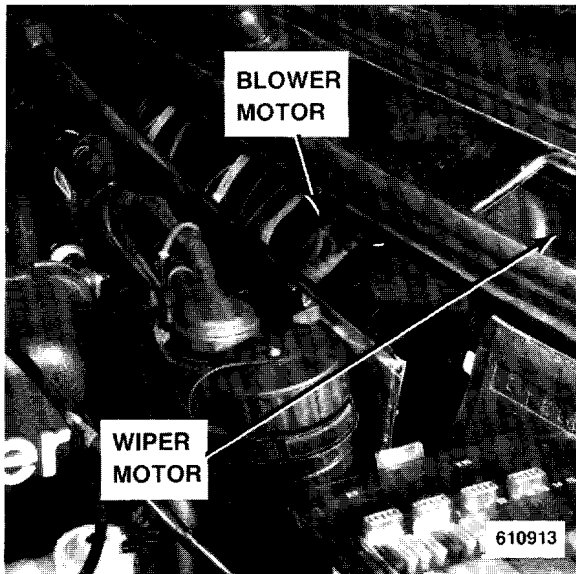

Figure 4 - LH Rear of Engine Compartment

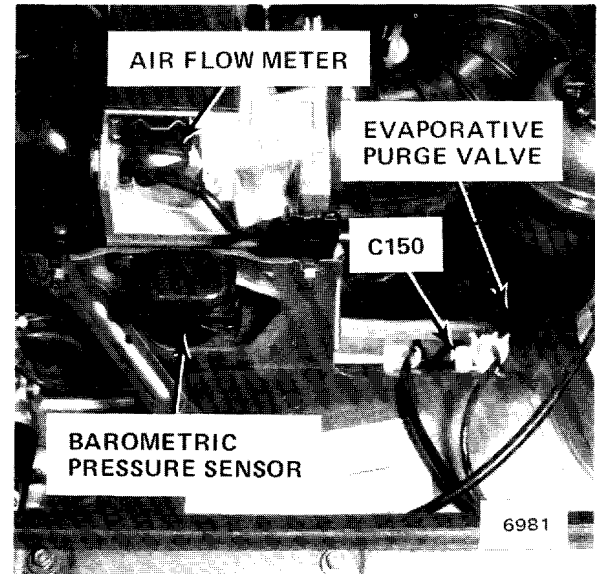
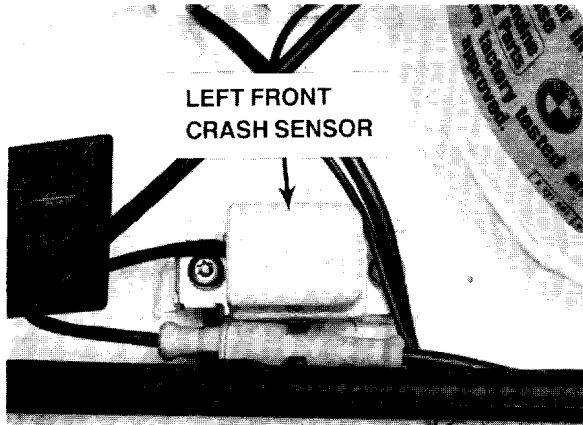
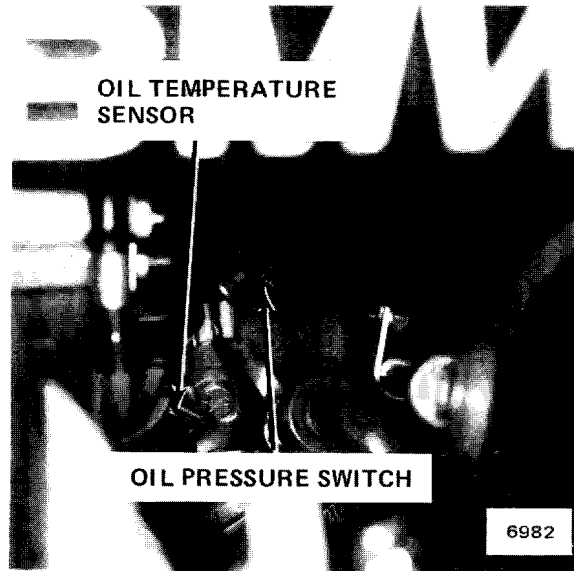

Figure 6 - LH Side of Engine Compartment



614201

Figure 1 - LH Side of Engine Compartment, Forward of Shock Tower



6982

Figure 3 - Lower LH Front of Engine

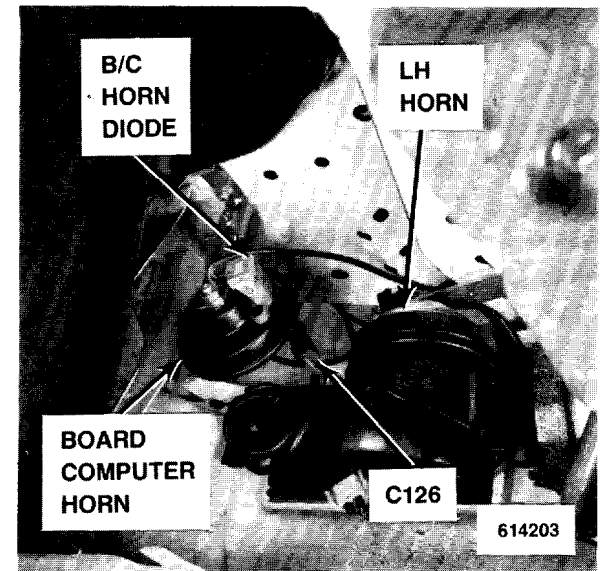

614203

Figure 5 - Behind LH Corner of Front Bumper

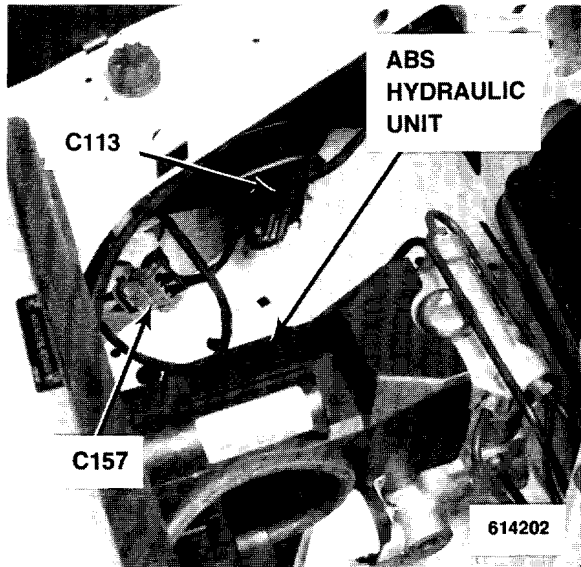

614202

Figure 2 - LH Front Corner of Engine Compartment

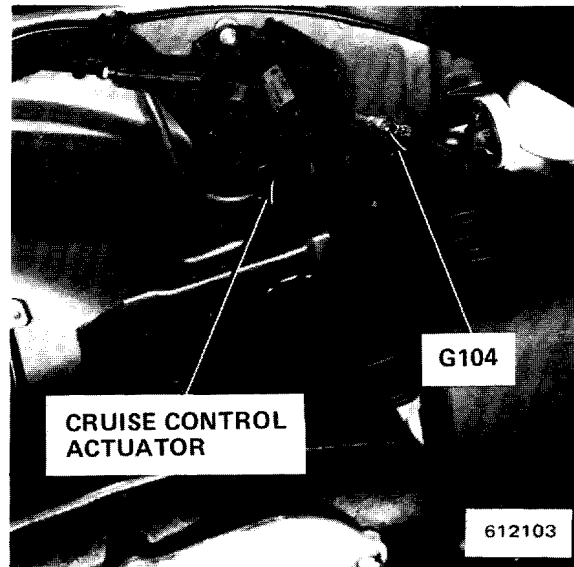

612103

Figure 4 - LH Front Corner of Engine Compartment

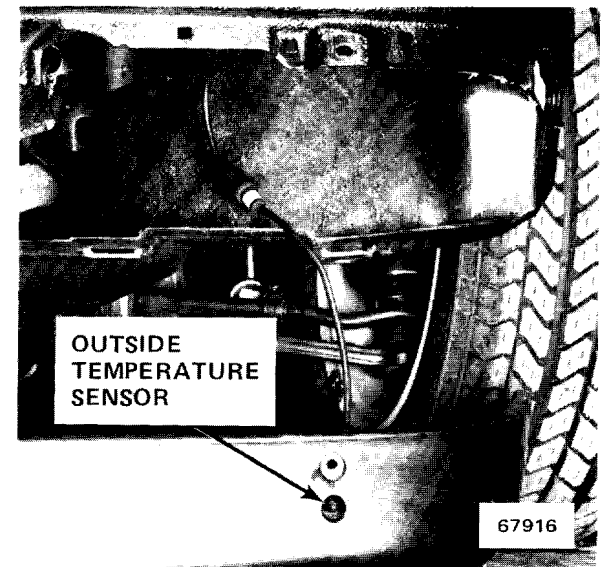

67916

Figure 6 - Under LH Side of Front Bumper (Splash Guard Pulled Down)

7000-2 COMPONENT LOCATION VIEWS

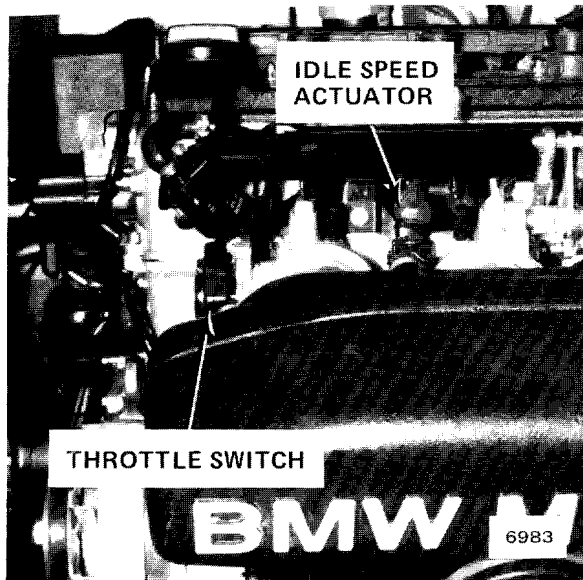

Figure 1 - Top Center Front of Engine

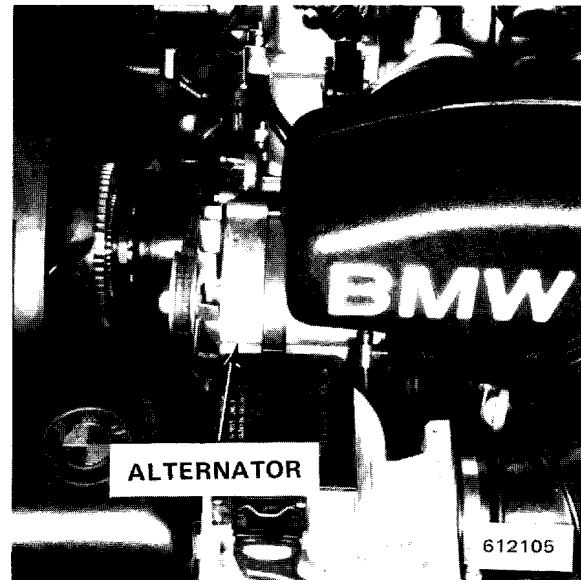

Figure 3 - LH Front of Engine

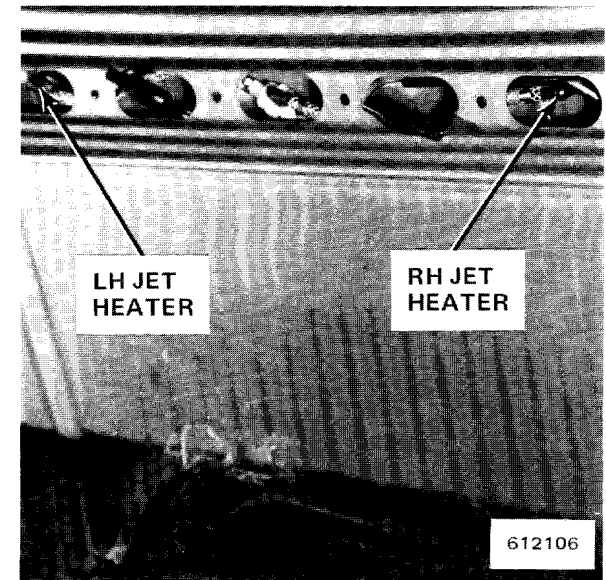

Figure 5 - Center of Engine Compartment Hood

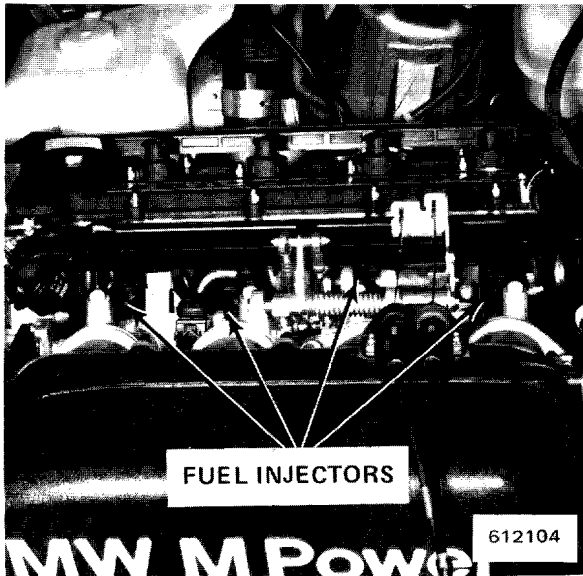

Figure 2 - Top of Engine

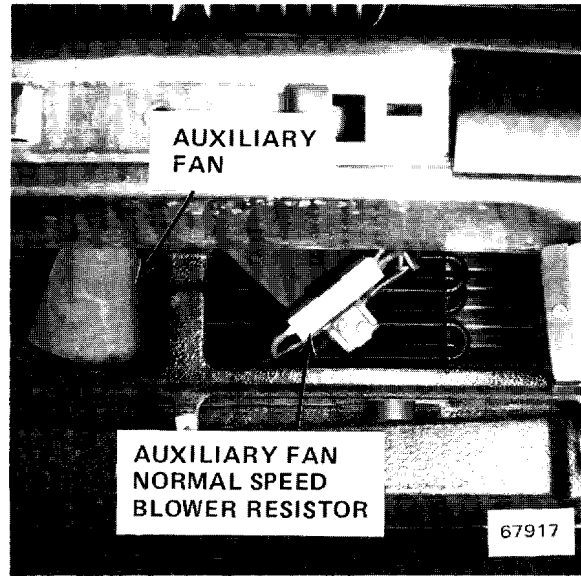

Figure 4 - Behind Center of Front Bumper

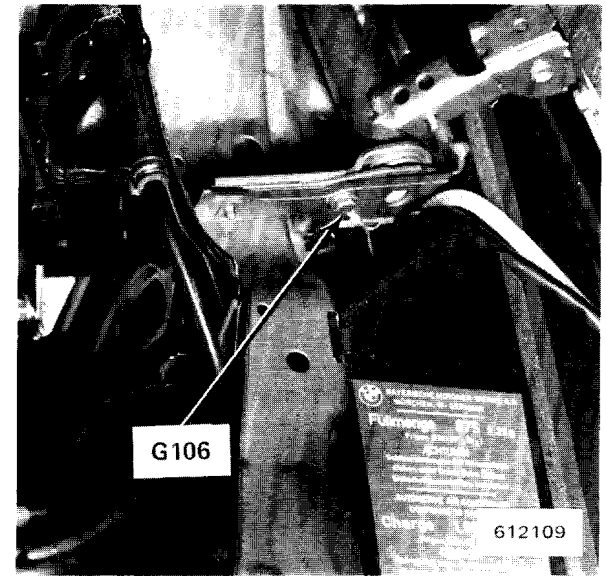

Figure 6 - RH Front Corner of Engine Compartment

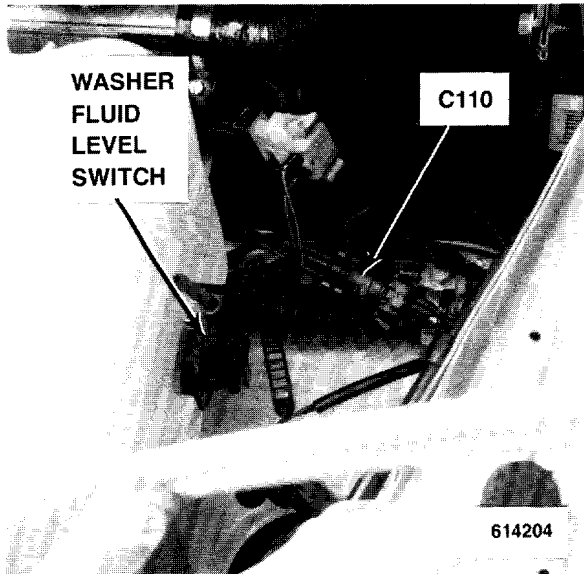

Figure 1 - RH Front Corner of Engine Compartment

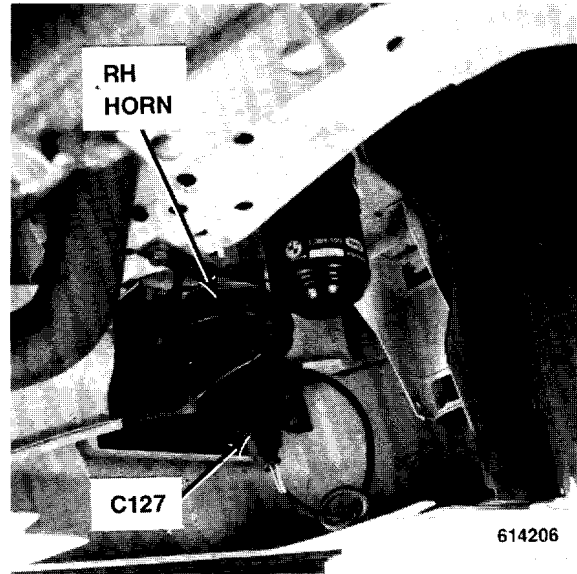

Figure 3 - Behind RH Corner of Front Bumper

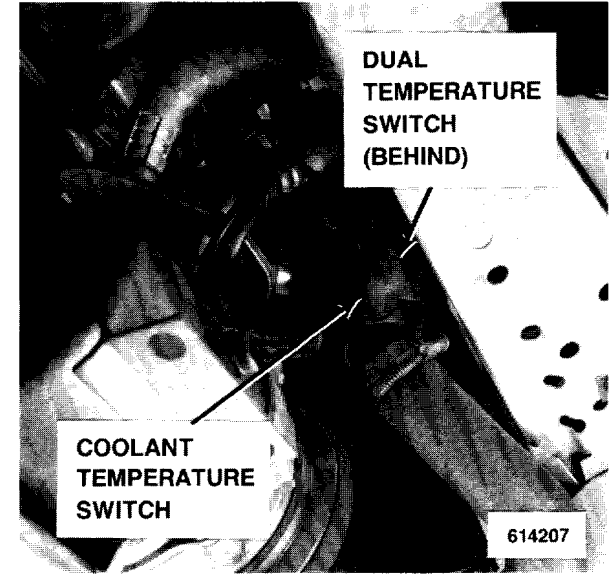

Figure 5 - Lower RH Front of Engine Compartment

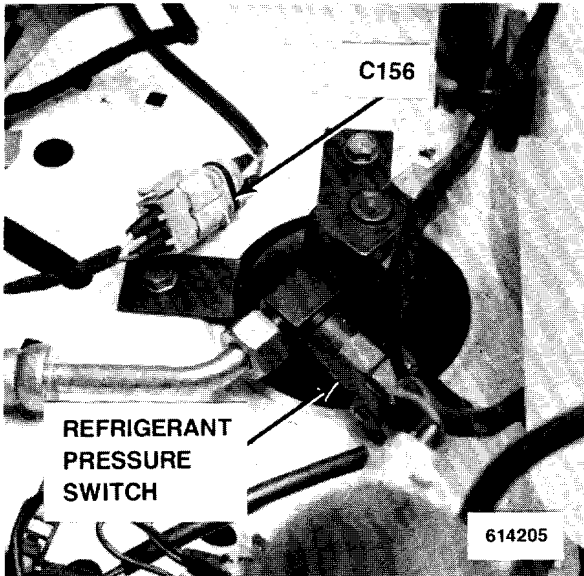

Figure 2 - RH Front Corner of Engine Compartment

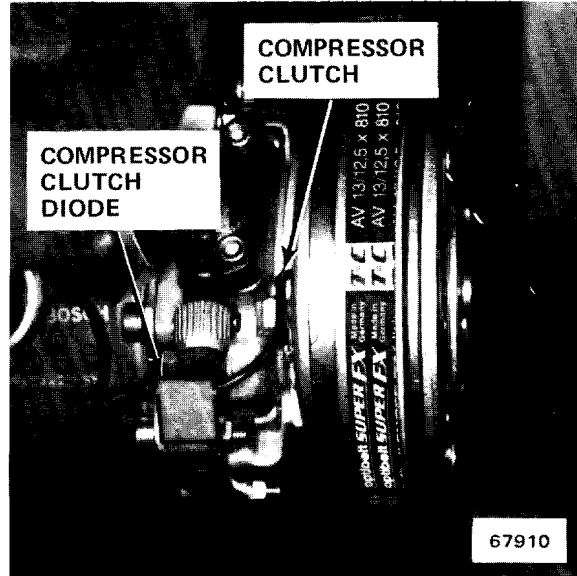

Figure 4 - Lower RH Front of Engine

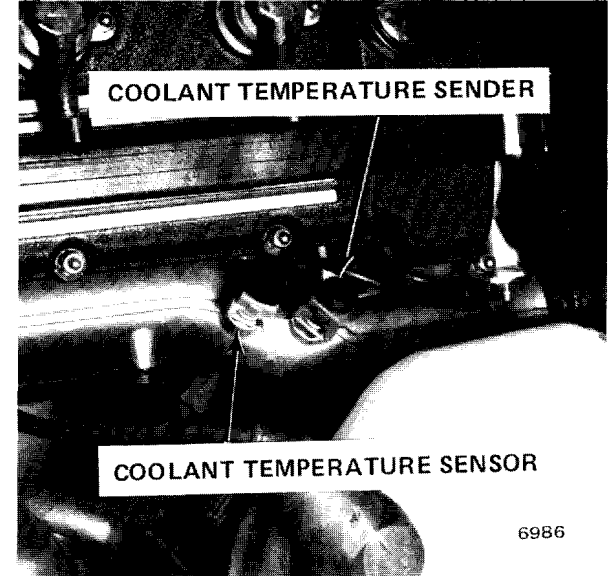

Figure 6 - RH Front of Engine

7000-4 COMPONENT LOCATION VIEWS

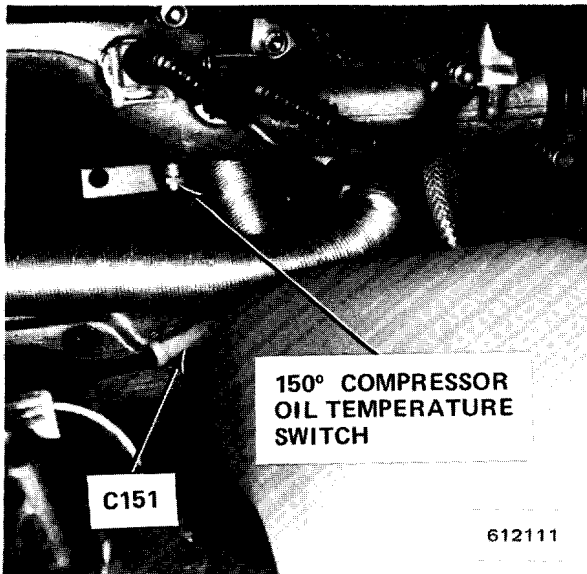

Figure 1 - Lower RH Side of Engine Compartment

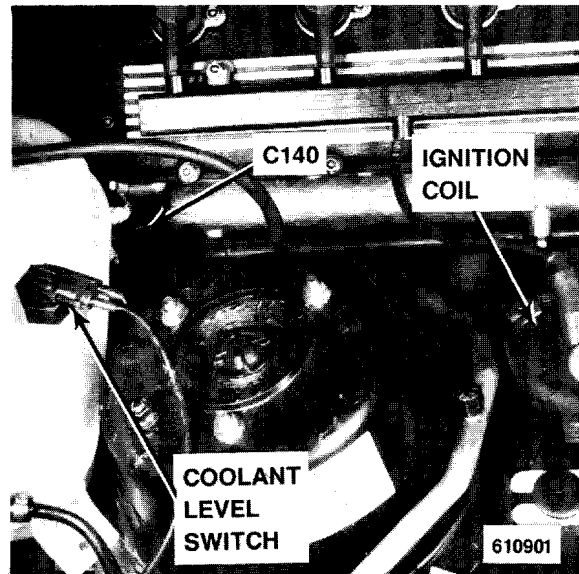

Figure 3 - RH Side of Engine Compartment

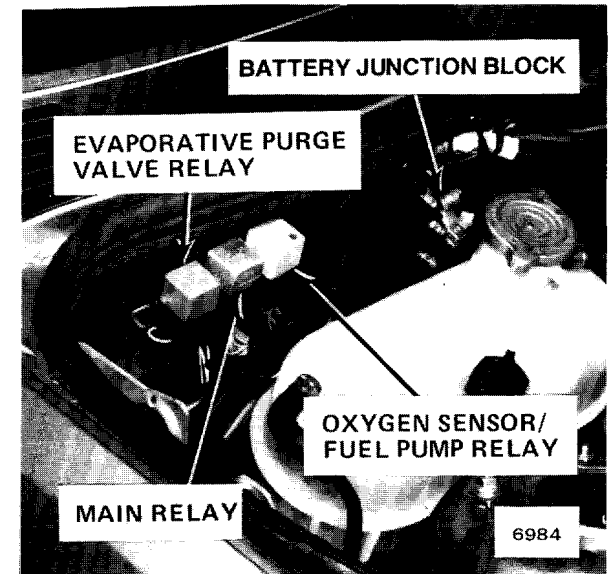

Figure 5 - RH Rear Corner of Engine Compartment

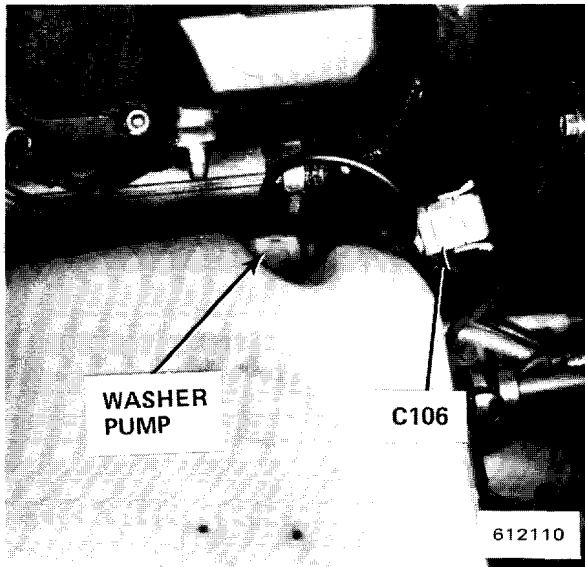

Figure 2 - RH Side of Engine Compartment

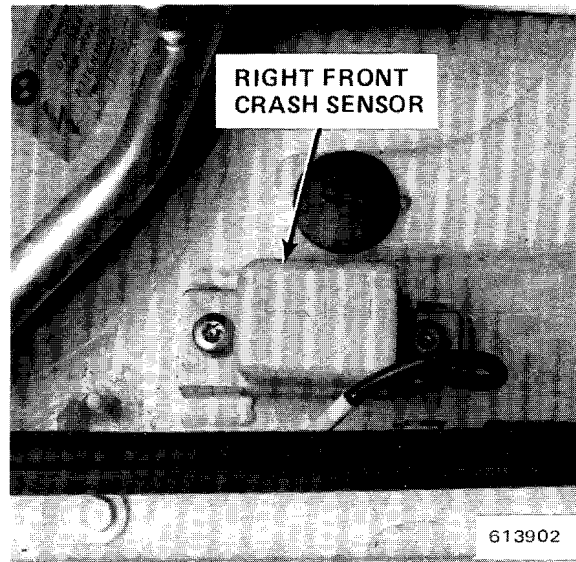

Figure 4 - RH Side of Engine Compartment, Forward of Shock Tower

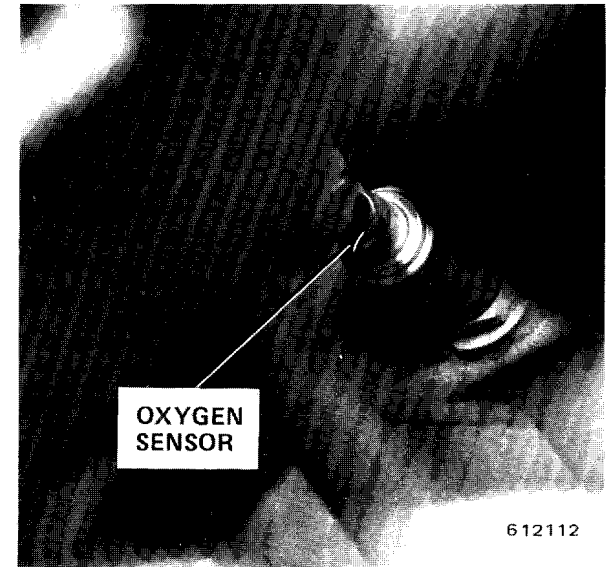

Figure 6 - Lower RH Rear of Engine Compartment

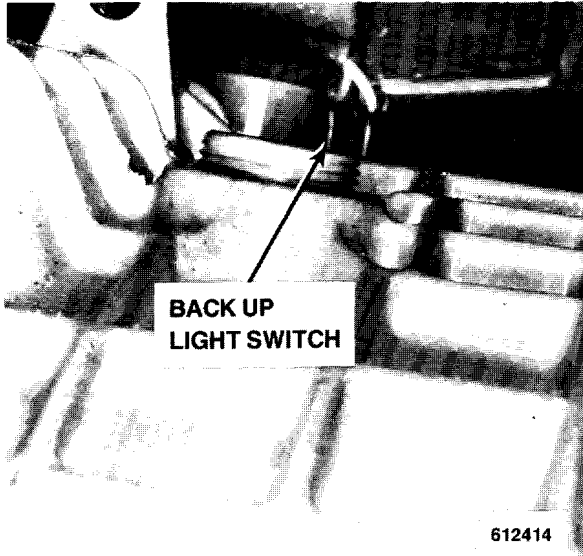

Figure 1 - Below Center of Car, RH Side of Transmission

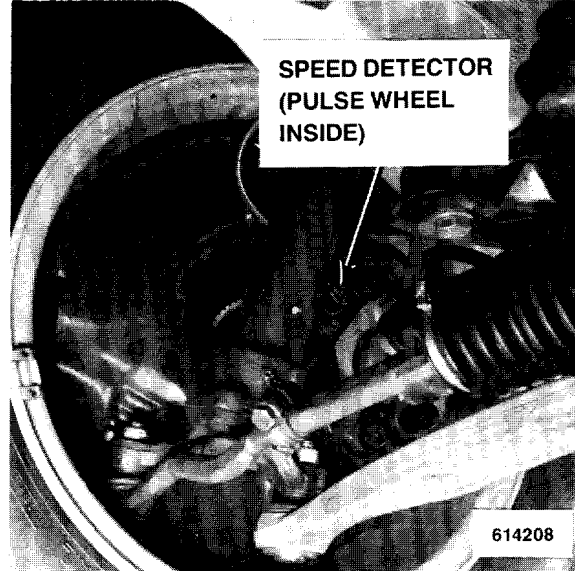

Figure 3 - Behind LH Front Wheel (All Others Similar)

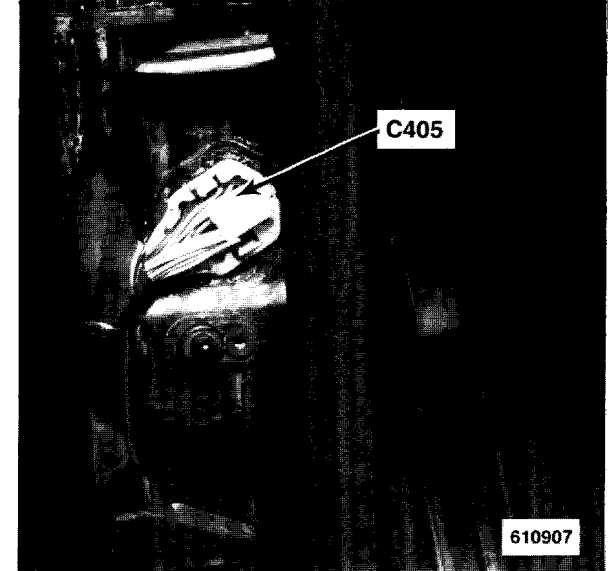

Figure 5 - Front of LH Door Jamb

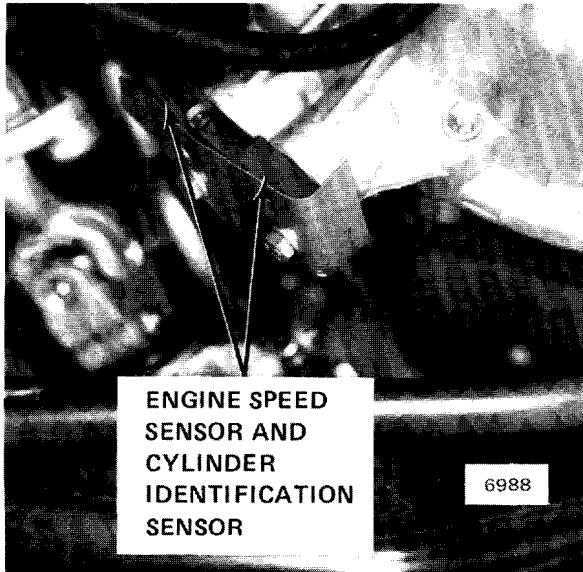

Figure 2 - Below Center of Car, LH Side of Transmission Bell Housing

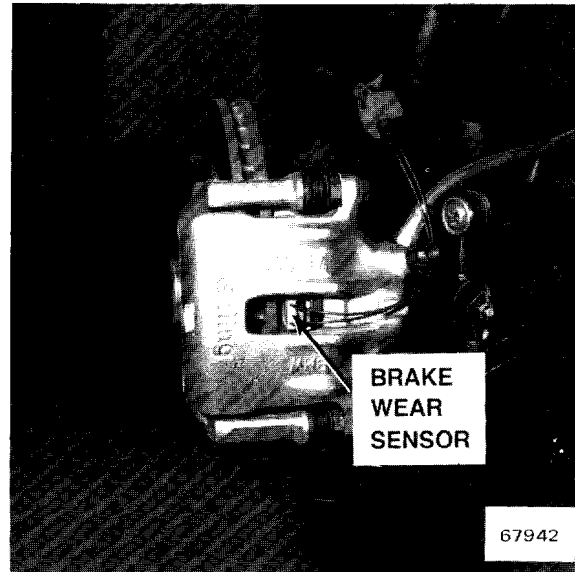

Figure 4 - LH Front Brake Caliper Assembly (RH Rear Similar)

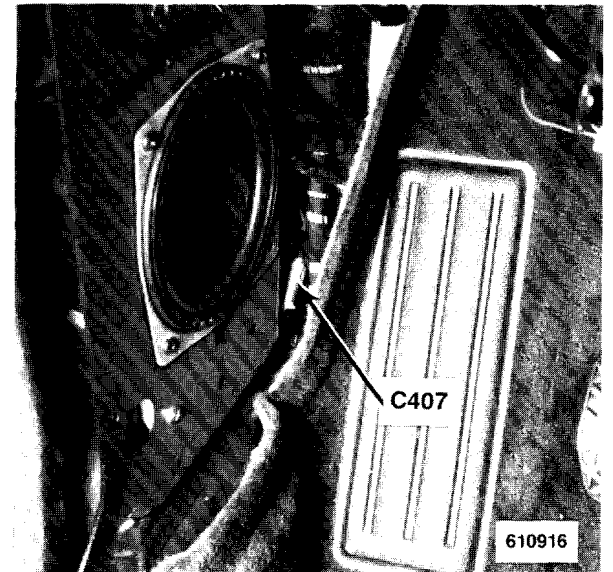

Figure 6 - LH Kick Panel

7000-6 COMPONENT LOCATION VIEWS

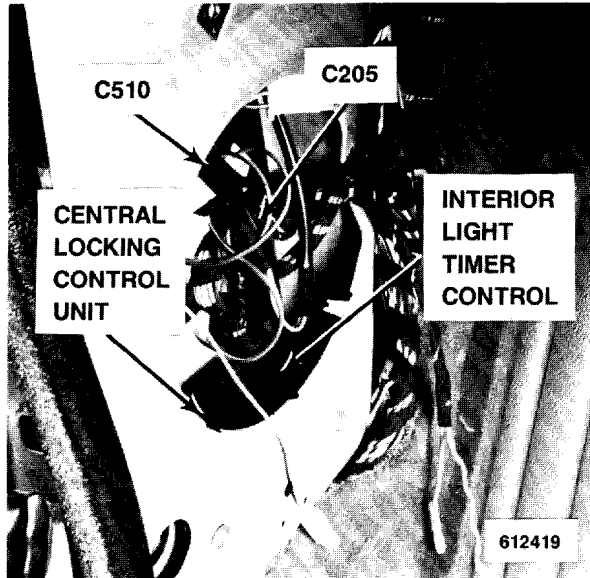

Figure 1 - Behind Left Front Speaker

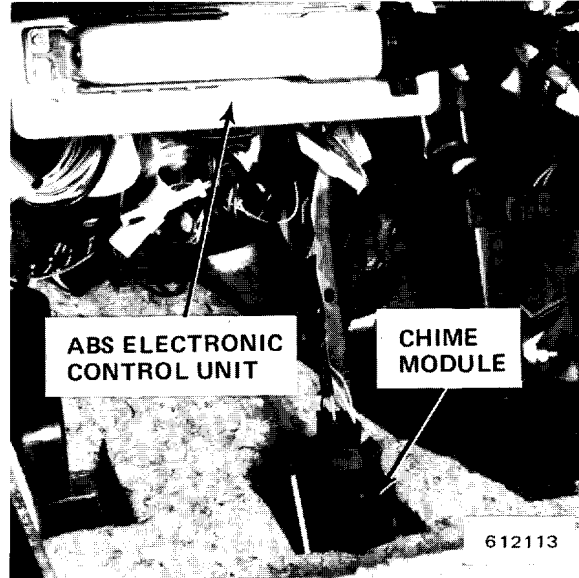

Figure 3 - Below LH Side of Dash, Left of Steering Column

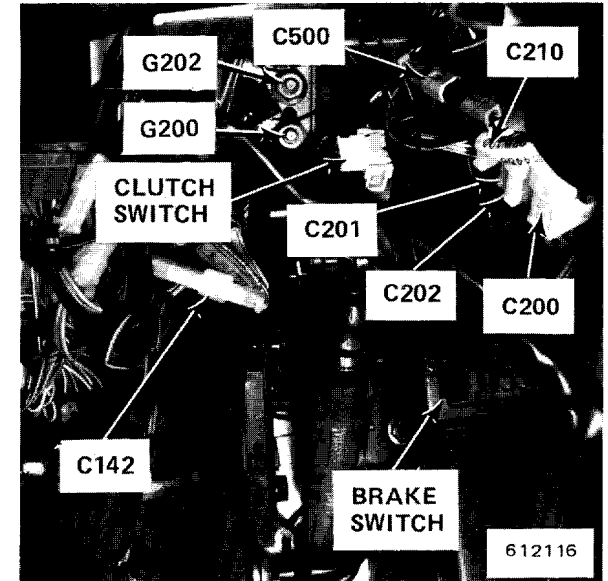

Figure 5 - Below LH Side of Dash, Left of Steering Column

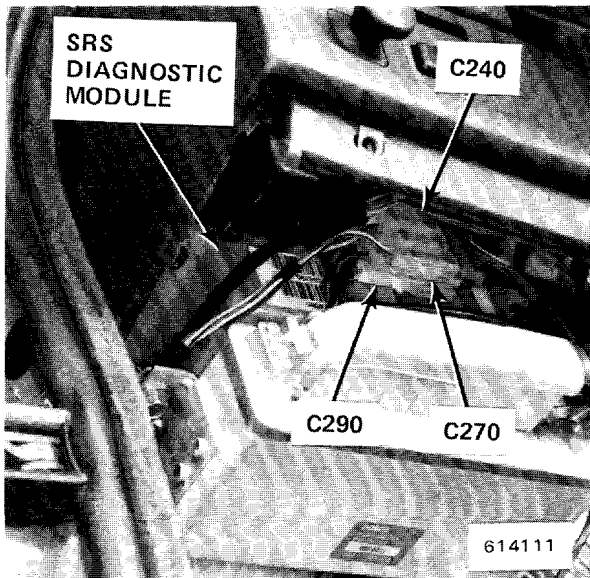

Figure 2 - Below LH Side of Dash, Left of Steering Column

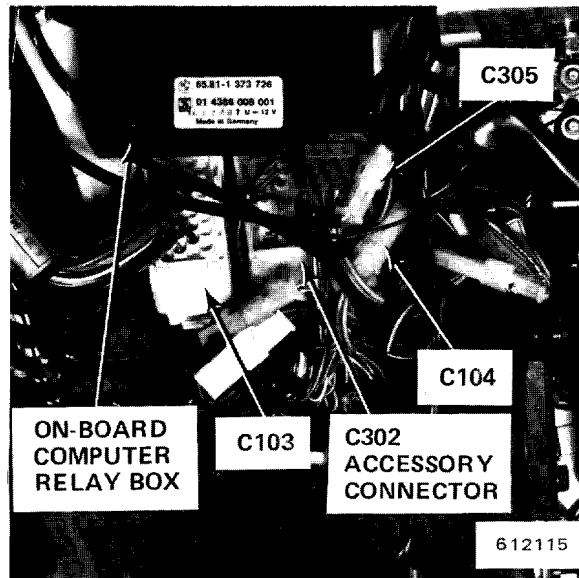

Figure 4 - Below LH Side of Dash, Left of Steering Column

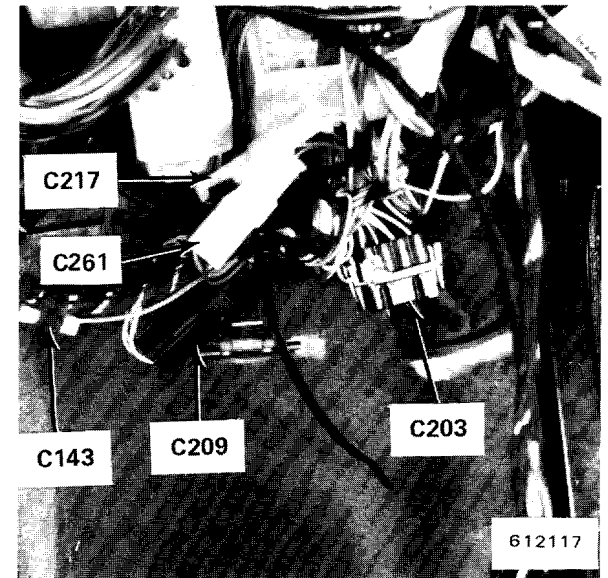

Figure 6 - Below LH Side of Dash, Left of Steering Column

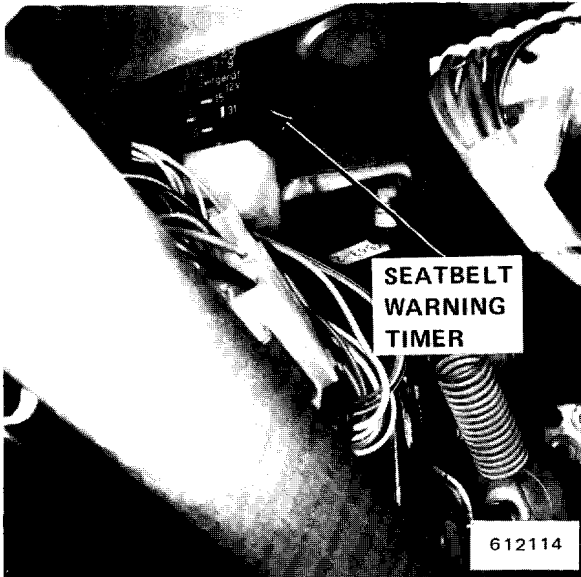

Figure 1 - Below LH Side of Dash, Above Steering Column

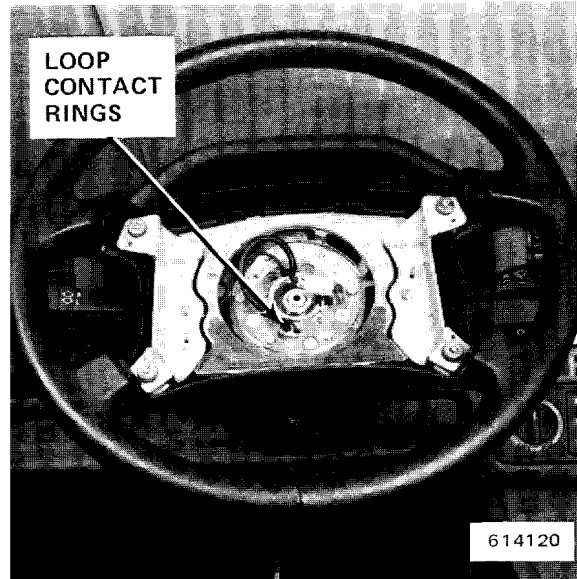

Figure 3 - Top of Steering Column (Air Bag Gas Generator Removed)

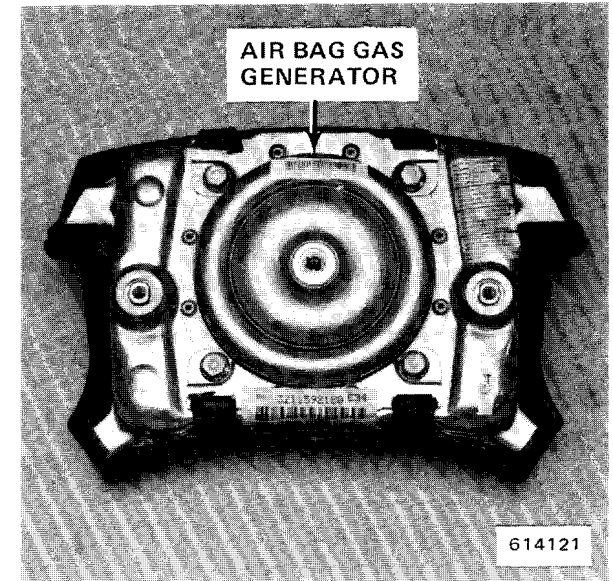

Figure 5 - Inside Steering Wheel (Removed From Car)

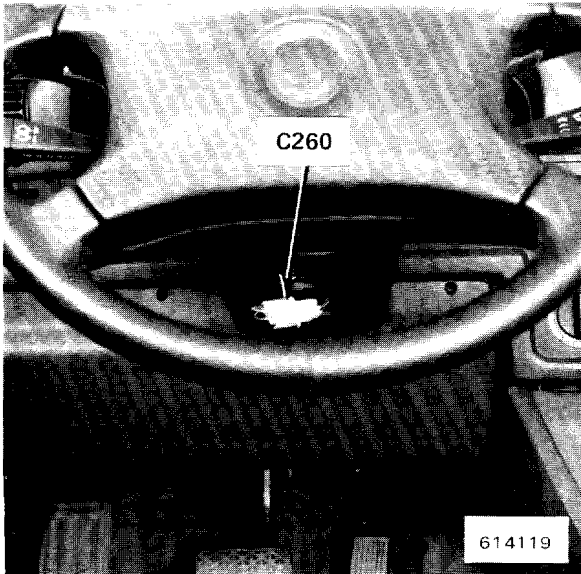

Figure 2 - Underside of Steering Column

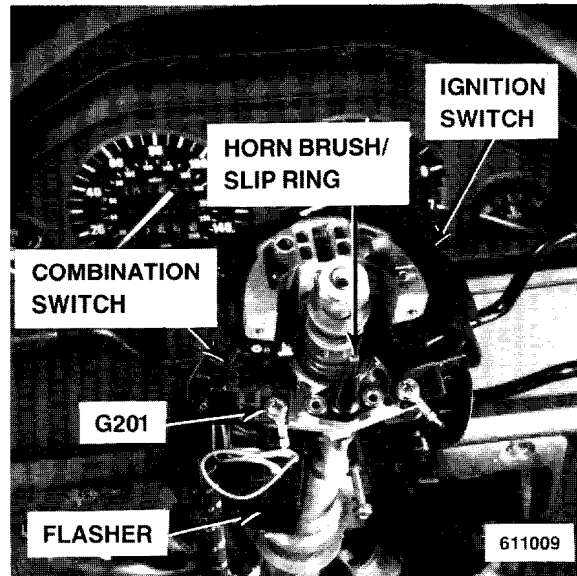

Figure 4 - Top of Steering Column (Steering Wheel Removed)

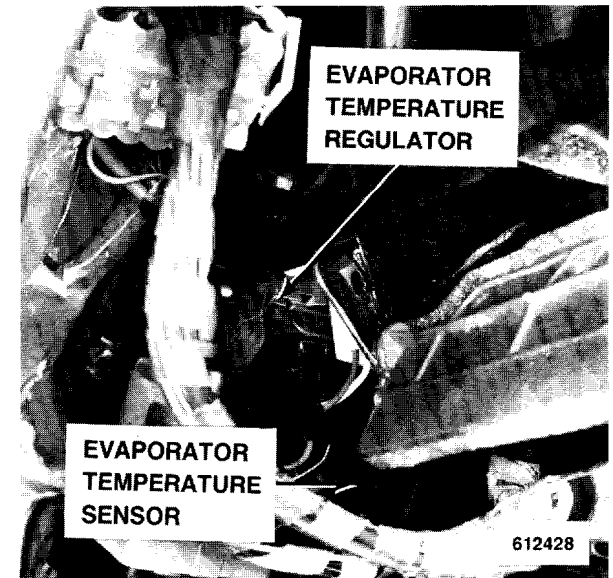

Figure 6 - LH Side of Evaporator Housing

7000-8 COMPONENT LOCATION VIEWS

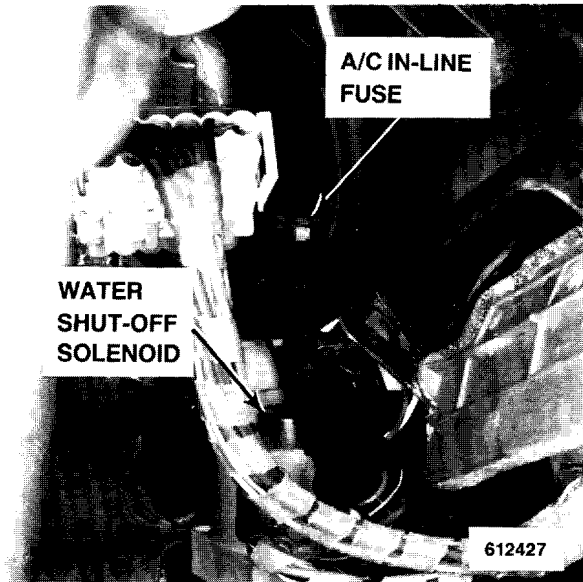

Figure 1 - LH Side of Evaporator Housing

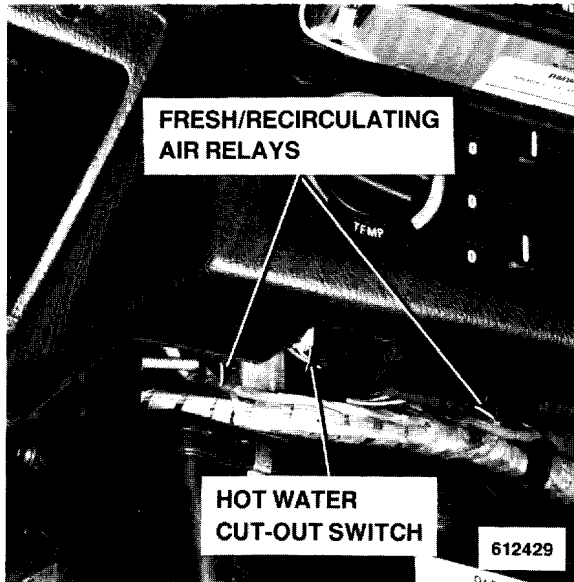

Figure 3 - Behind Center of Dash

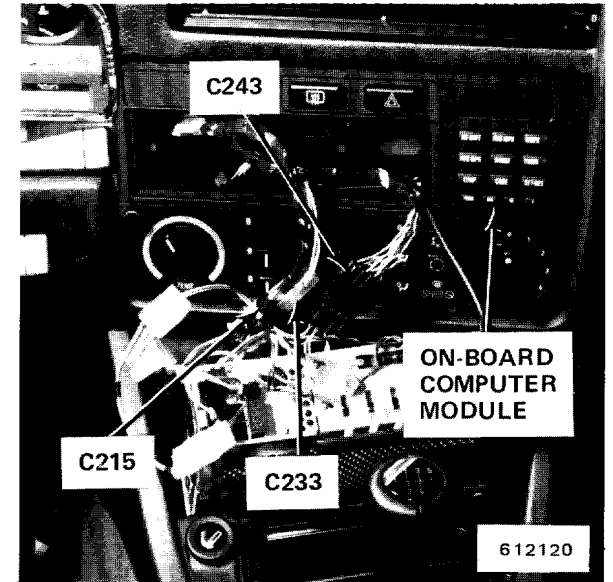

Figure 5 - Behind Center of Dash



Figure 2 - LH Side of Evaporator Housing

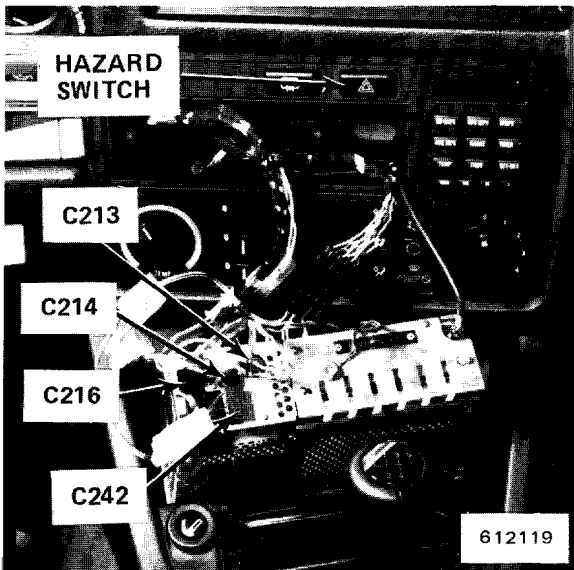

Figure 4 - Behind Center of Dash



Figure 6 - Center of Windshield Header

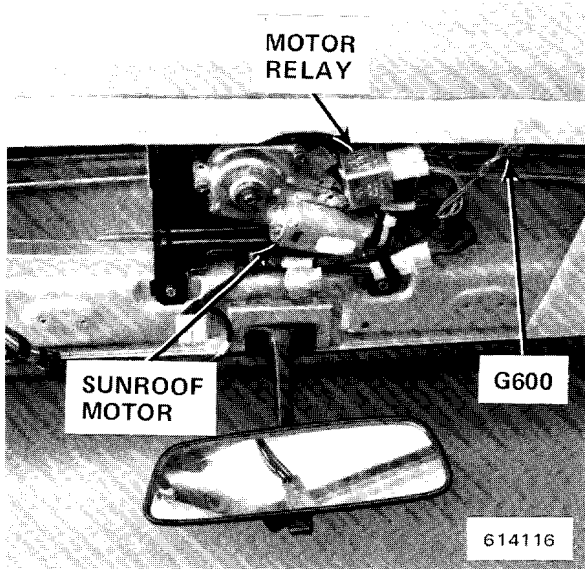

Figure 1 - Center of Windshield Header

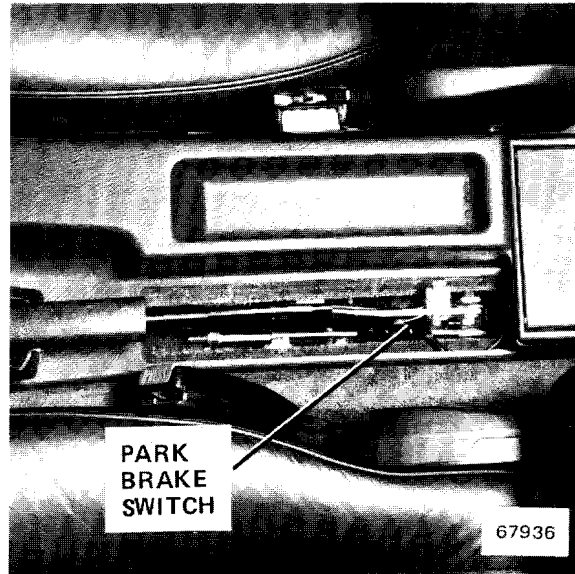

Figure 3 - Below Rear of Center Console

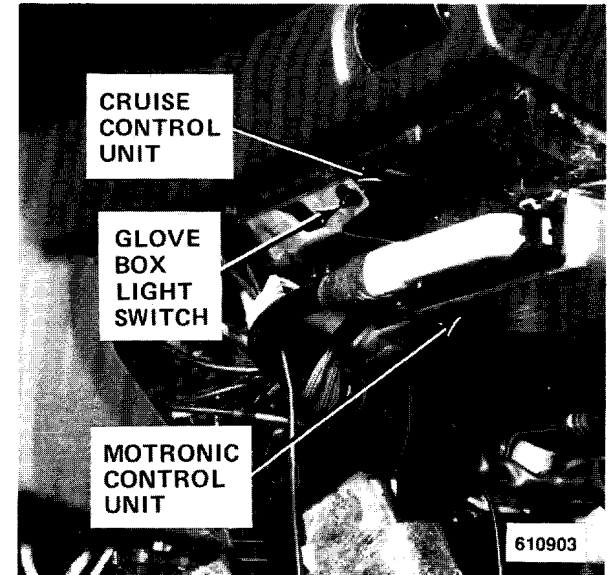

Figure 5 - Behind RH Side of Dash

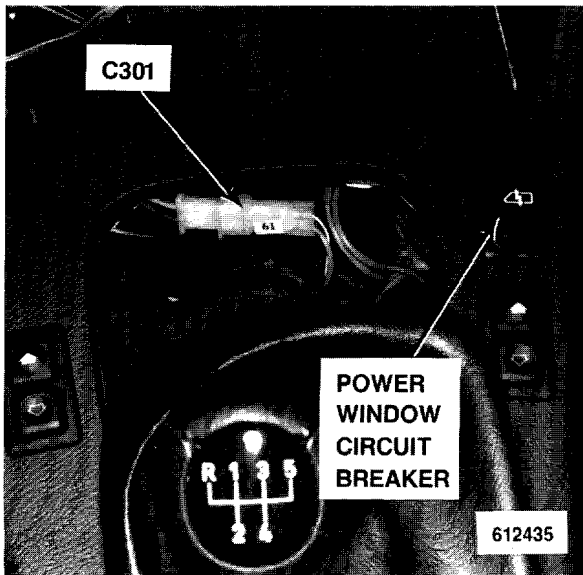

Figure 2 - Below Center Console

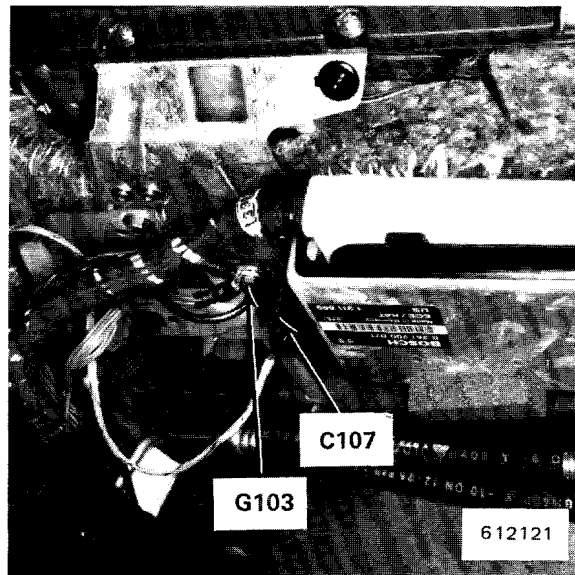

Figure 4 - Behind RH Side of Dash

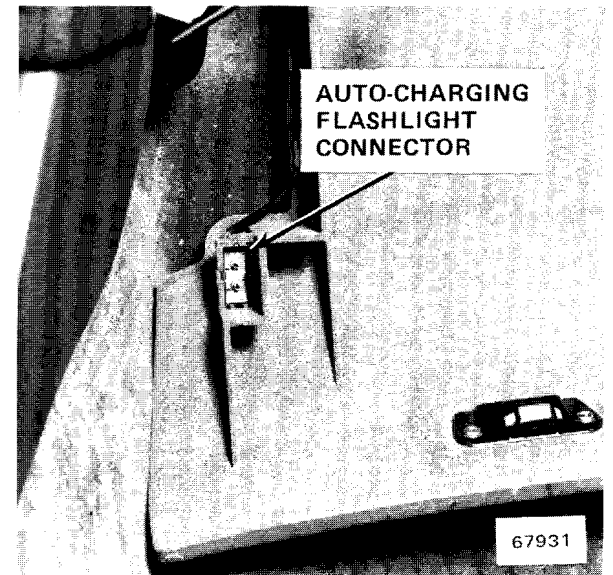

Figure 6 - LH Side of Glove Box

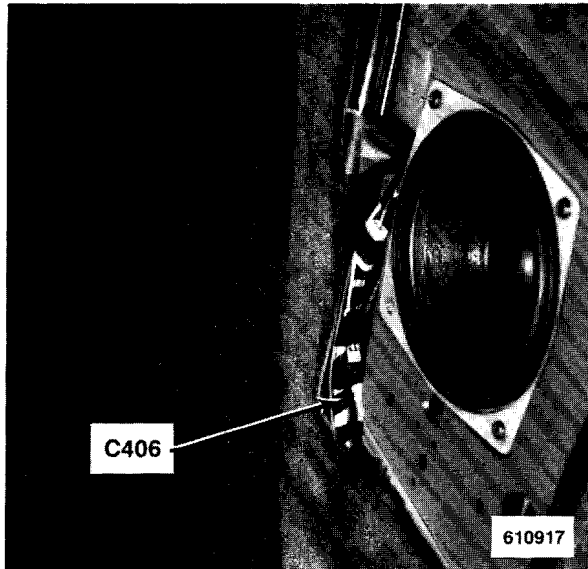

Figure 1 - RH Kick Panel

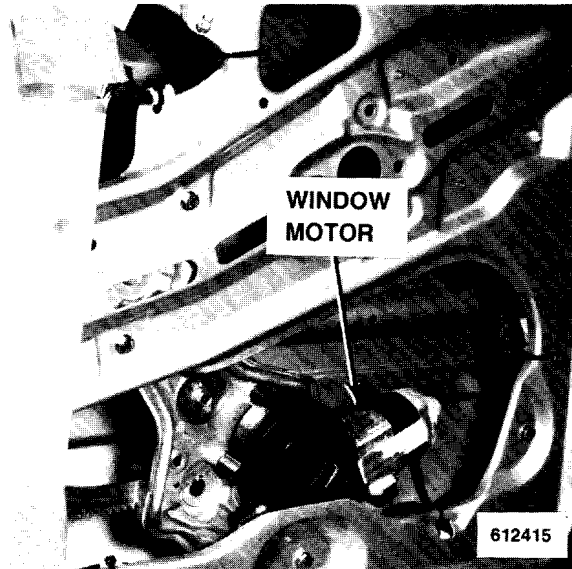

Figure 3 - Lower Front of LH Door (RH Similar)

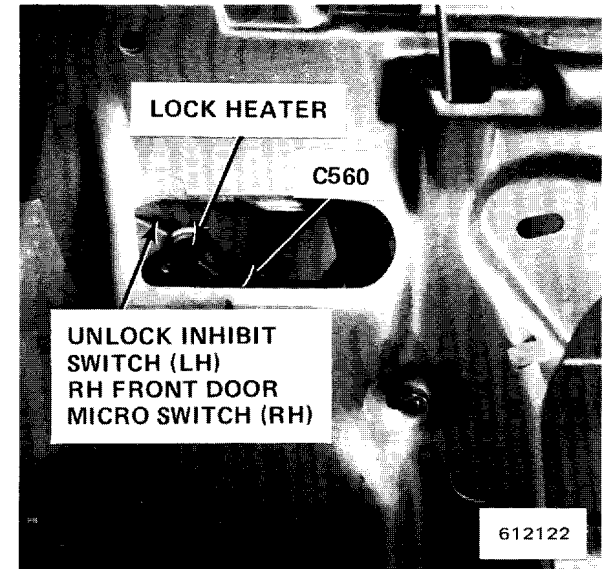

Figure 5 - Top Rear of LH Door (RH Similar)

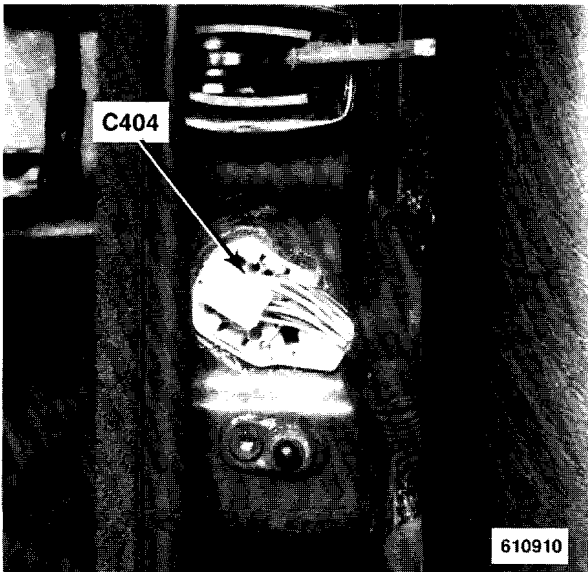

Figure 2 - Front of RH Door Jamb

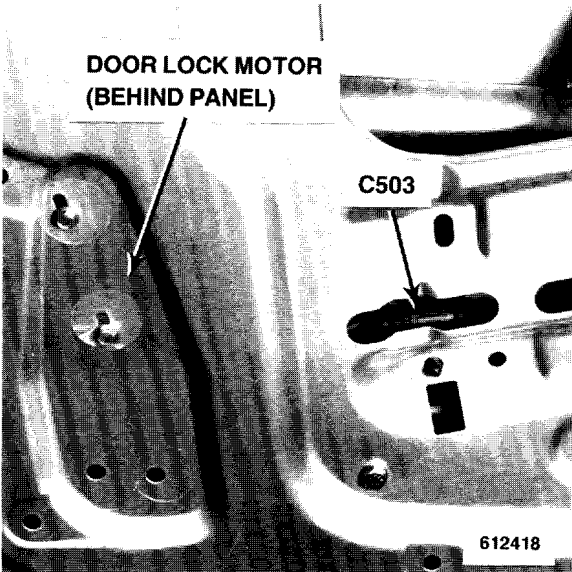

Figure 4 - Lower Rear of LH Door (RH Similar)

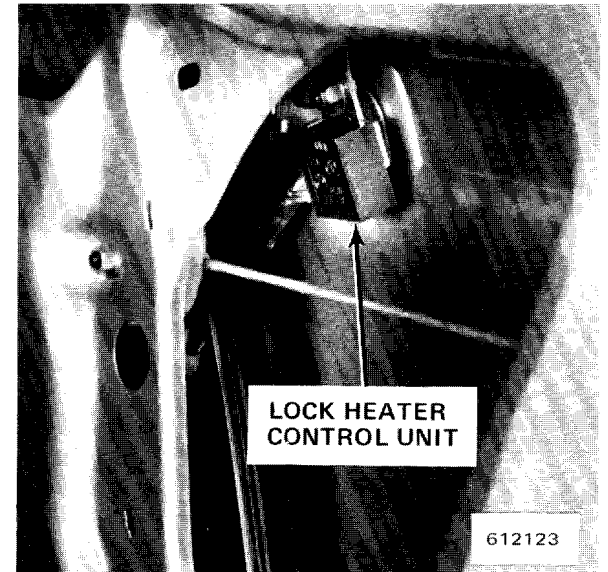

Figure 6 - Top Rear of LH Door (RH Similar)

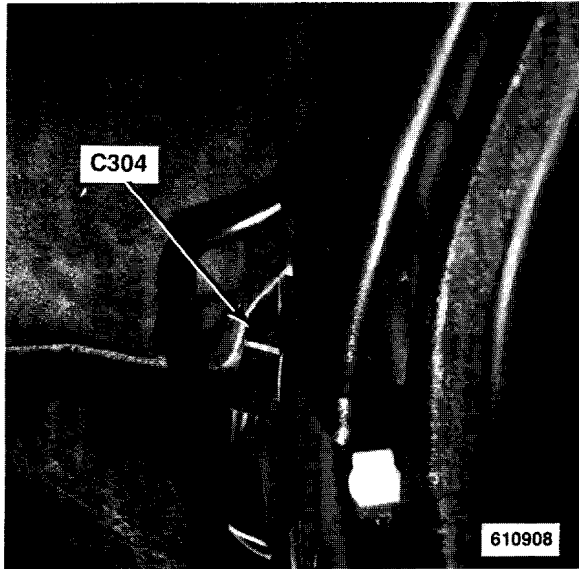

Figure 1 - Base of LH "B" Pillar

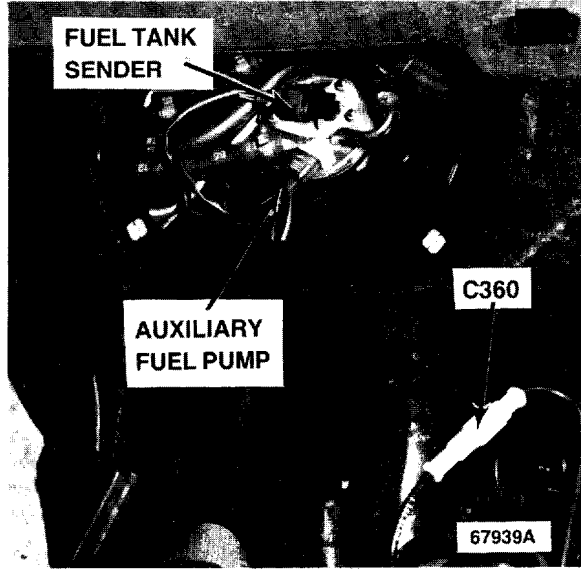

Figure 3 - Below RH Side of Rear Seat

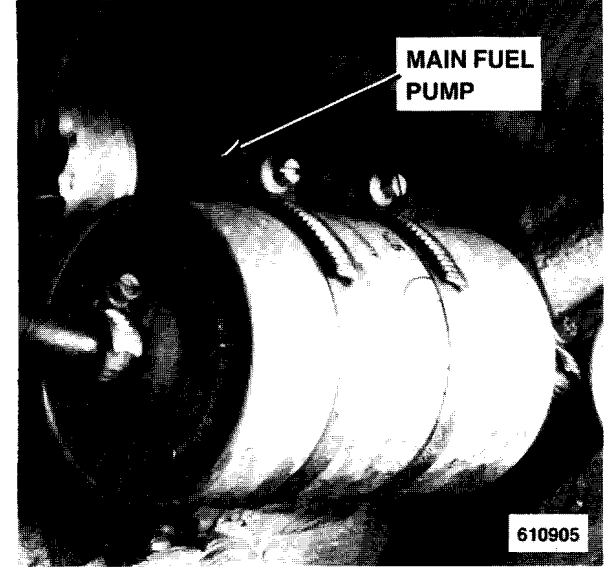

Figure 5 - Below LH Rear of Car, Forward of Rear Wheel

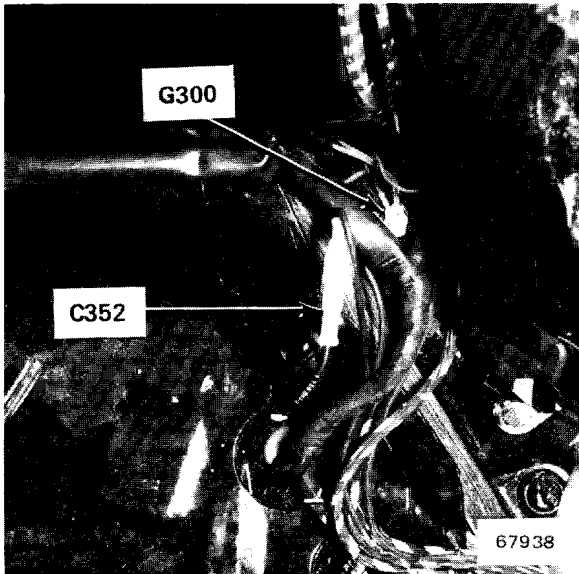

Figure 2 - Below LH Side of Rear Seat

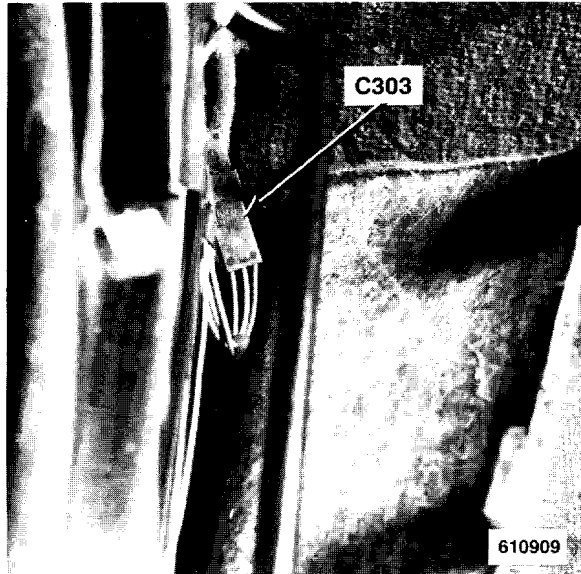

Figure 4 - Base of RH "B" Pillar

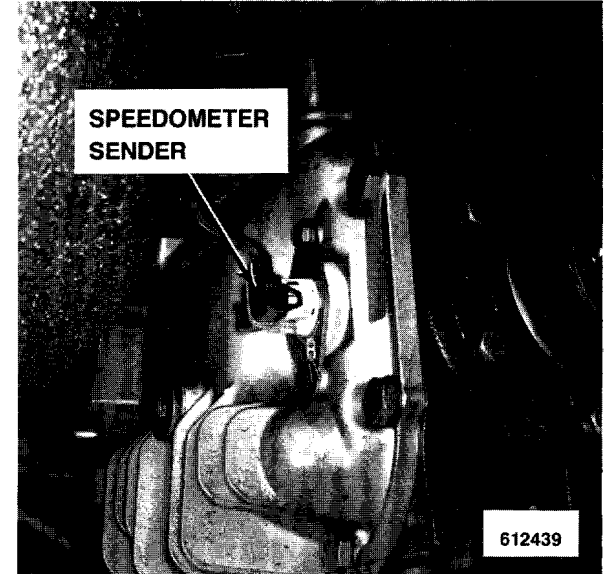

Figure 6 - RH Rear of Rear Differential

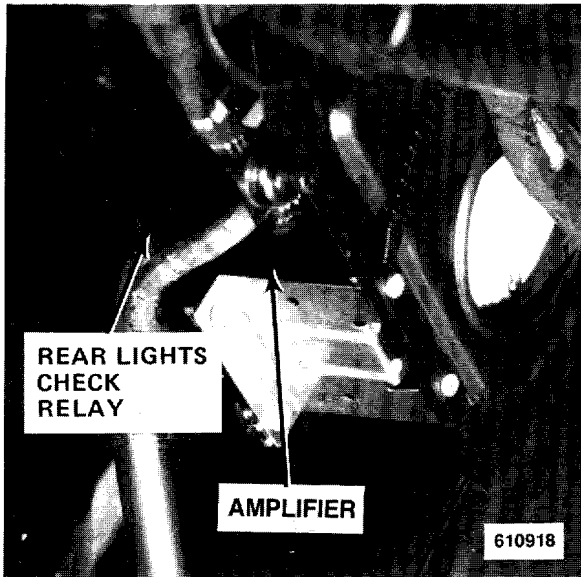

Figure 1 - LH Side of Trunk

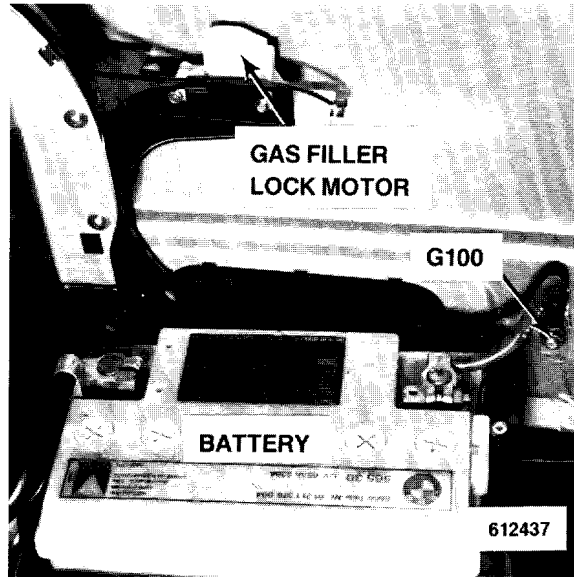

Figure 3 - RH Side of Trunk



Figure 2 - Center Rear of Trunk

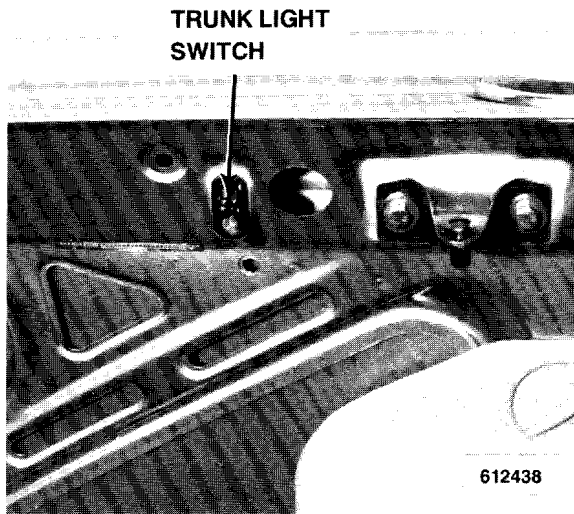

Figure 4 - Center Rear of Trunk Lid

8000-0 SPLICE LOCATION VIEWS

INDEX

This index contains all the splices in the car, what harness each one is in, and the page that the splices appear on. The drawings after the index show how the harness is routed through the car and where the splices are located on the harness.

SPLICE	HARNESS	PAGE NUMBER	SPLICE	HARNESS	PAGE NUMBER
S100	MAIN	8000-1	S210	MAIN	8000-1
S102	MAIN	8000-1	S211	MAIN	8000-1
S103	MAIN	8000-1	S212	MAIN	8000-1
S104	ENGINE (S14)	8000-2	S213	MAIN	8000-1
S105	ENGINE (S14)	8000-2	S215	MAIN	8000-1
S106	ENGINE (S14)	8000-2	S219	INSTRUMENT PANEL	8000-4
S107	ENGINE (S14)	8000-2	S221	INSTRUMENT PANEL	8000-4
S108	ENGINE (S14)	8000-2	S223	CRUISE CONTROL	NOT SHOWN
S112	ENGINE (S14)	8000-2	S226	A/C	NOT SHOWN
S114	MAIN	8000-1	S228	CRUISE CONTROL	NOT SHOWN
S115	MAIN	8000-1	S229	AIR CONDITIONING	NOT SHOWN
S116	MAIN	8000-1	S230	MAIN	8000-1
S118	MAIN	8000-1	S231	MAIN	8000-1
S119	MAIN	8000-1	S232	MAIN	8000-1
S125	JET HEATER	NOT SHOWN	S233	MAIN	8000-1
S126	JET HEATER	NOT SHOWN	S234	MAIN	8000-1
S150	ENGINE (S14)	8000-2	S239	MAIN	8000-1
S151	ENGINE (S14)	8000-2	S240	A/C	NOT SHOWN
S201	ON-BOARD COMPUTER	8000-5	S241	CRUISE CONTROL	NOT SHOWN
S202	ON-BOARD COMPUTER	8000-5	S242	MAIN	NOT SHOWN
S203	MAIN	8000-1	S250	A/C	NOT SHOWN
S207	MAIN	8000-1	S251	A/C	NOT SHOWN
S209	MAIN	8000-1	S252	A/C	NOT SHOWN

SPLICE	HARNESS	PAGE NUMBER
S260	MAIN	8000-1
S300	DOOR	8000-3
S301	DOOR	8000-3
S302	DOOR	8000-3
S303	DOOR	8000-3
S304	DOOR	8000-3
S305	DOOR	8000-3
S306	INSTRUMENT PANEL	8000-4
S307	INSTRUMENT PANEL	8000-4
S309	DOOR	8000-3
S310	MAIN	8000-1
S316	MAIN	8000-1
S319	MAIN	8000-1
S322	DOOR	8000-3
S324	MAIN	8000-1
S326	MAIN	8000-1
S329	MAIN	8000-1
S330	MAIN	8000-1
S332	DOOR	8000-3
S333	DOOR	8000-3
S340	MAIN	8000-1
S341	MAIN	8000-1
S342	DOOR	8000-3
S345	RADIO	NOT SHOWN
S400	RADIO	NOT SHOWN
S403	RADIO	NOT SHOWN
S404	RADIO	NOT SHOWN
S411	DOOR	8000-3
S501	DOOR	8000-3
S502	DOOR	8000-3
S503	DOOR	8000-3
S504	DOOR	8000-3
S540	HEATED SEATS	NOT SHOWN
S541	HEATED SEATS	NOT SHOWN
S542	HEATED SEATS	NOT SHOWN

8000-2 SPLICE LOCATION VIEWS

MAIN HARNESS SPLICE LOCATIONS

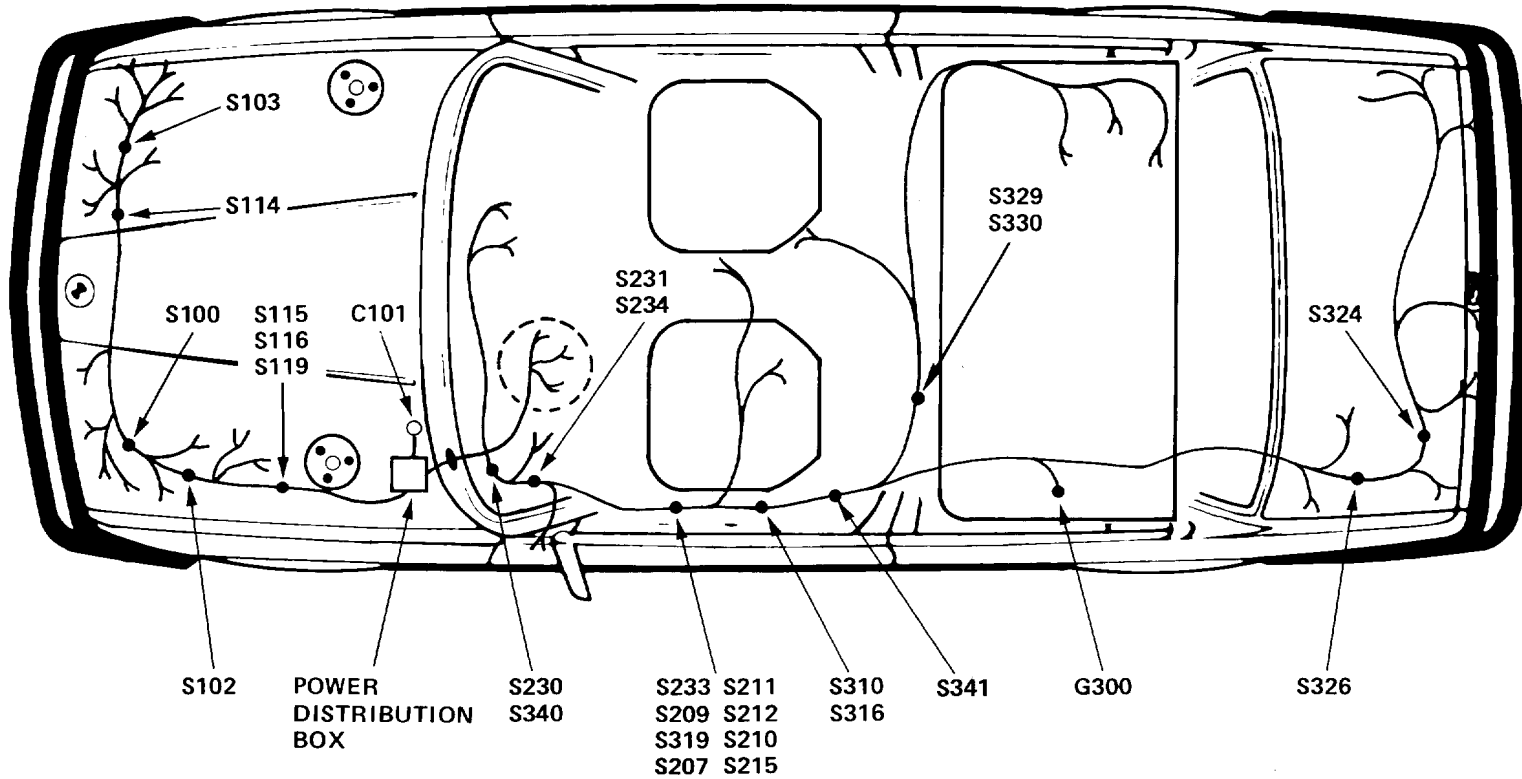
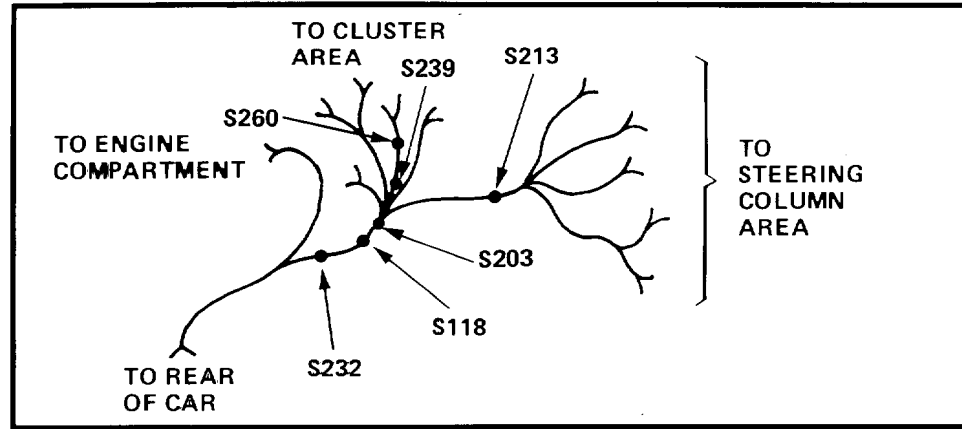

ENGINE HARNESS SPLICE LOCATIONS

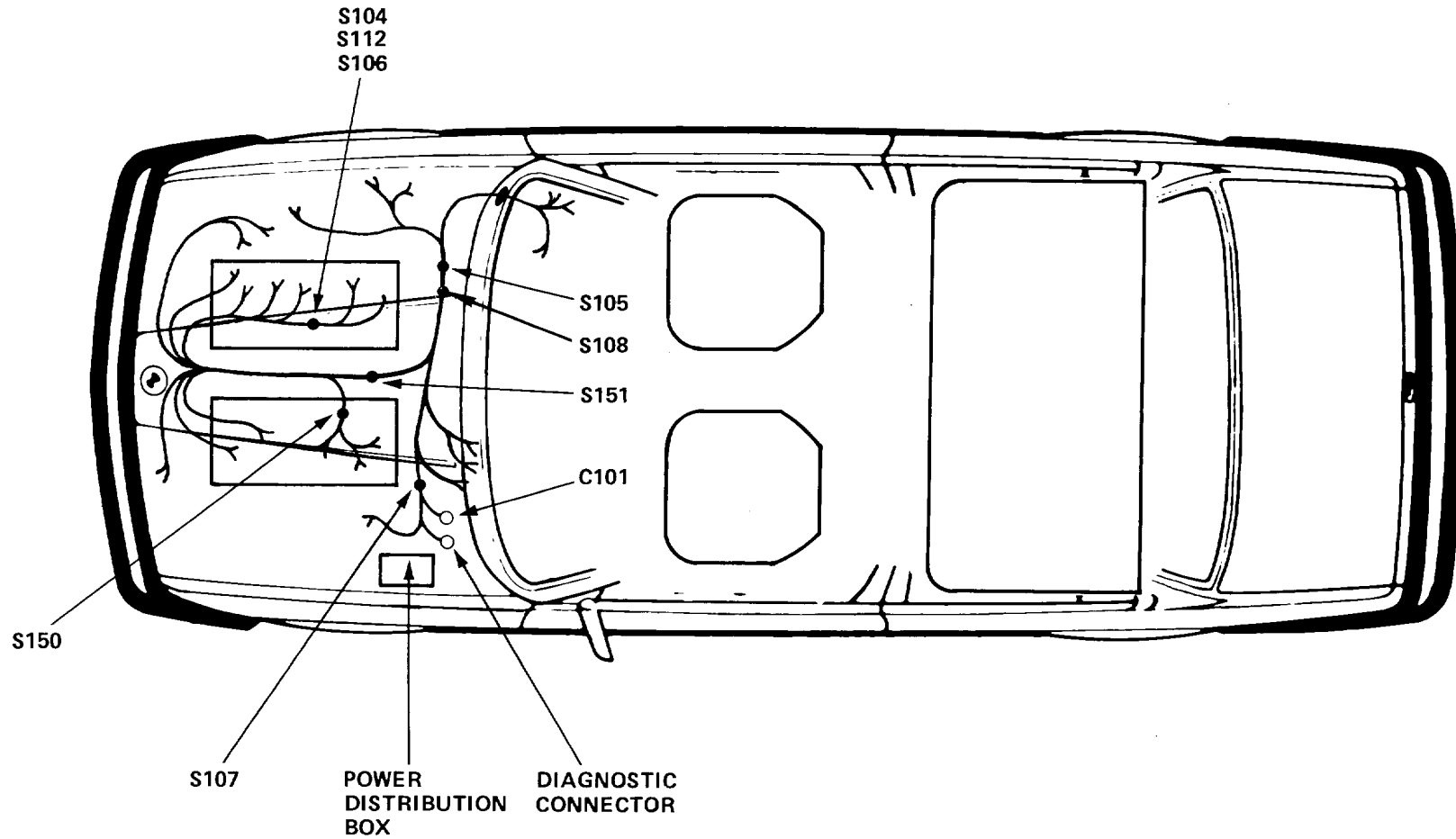

8000-4 SPlice LOCATION VIEWS

DOOR HARNESS SPlice LOCATIONS

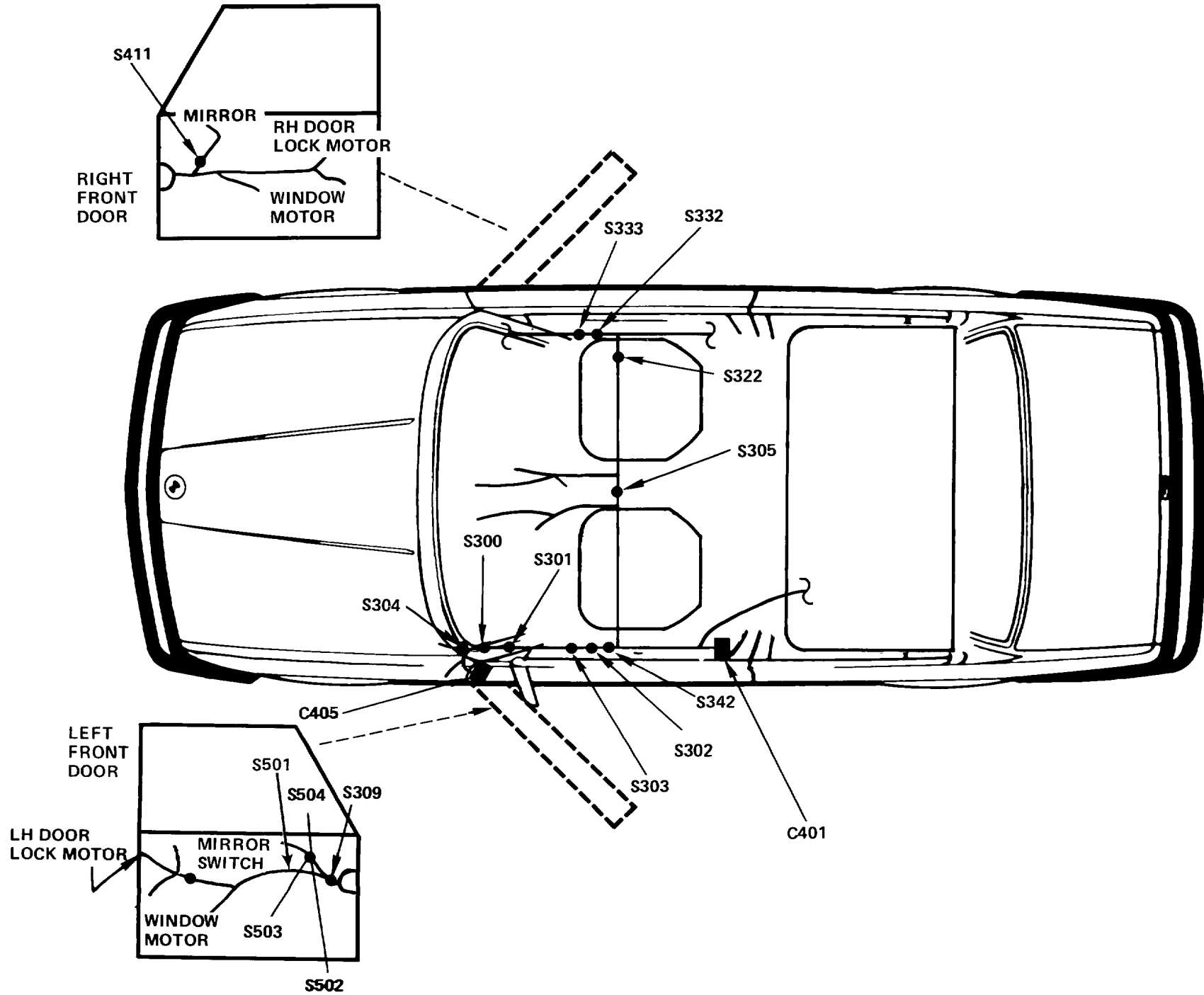

INSTRUMENT PANEL HARNESS SPlice LOCATIONS

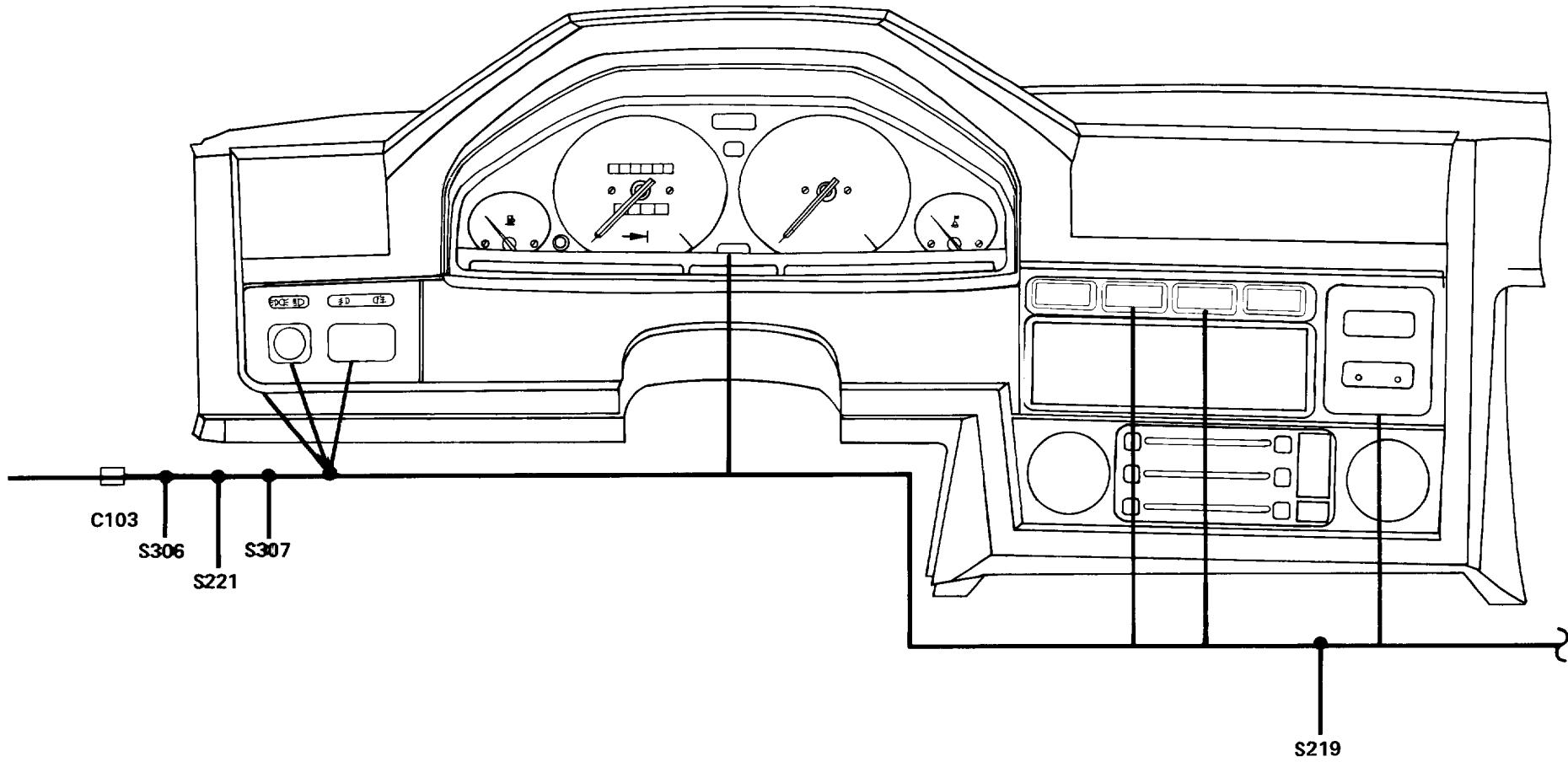

8000-6 SPlice LOCATION VIEWS

ON-BOARD COMPUTER HARENSS SPLICE LOCATIONS

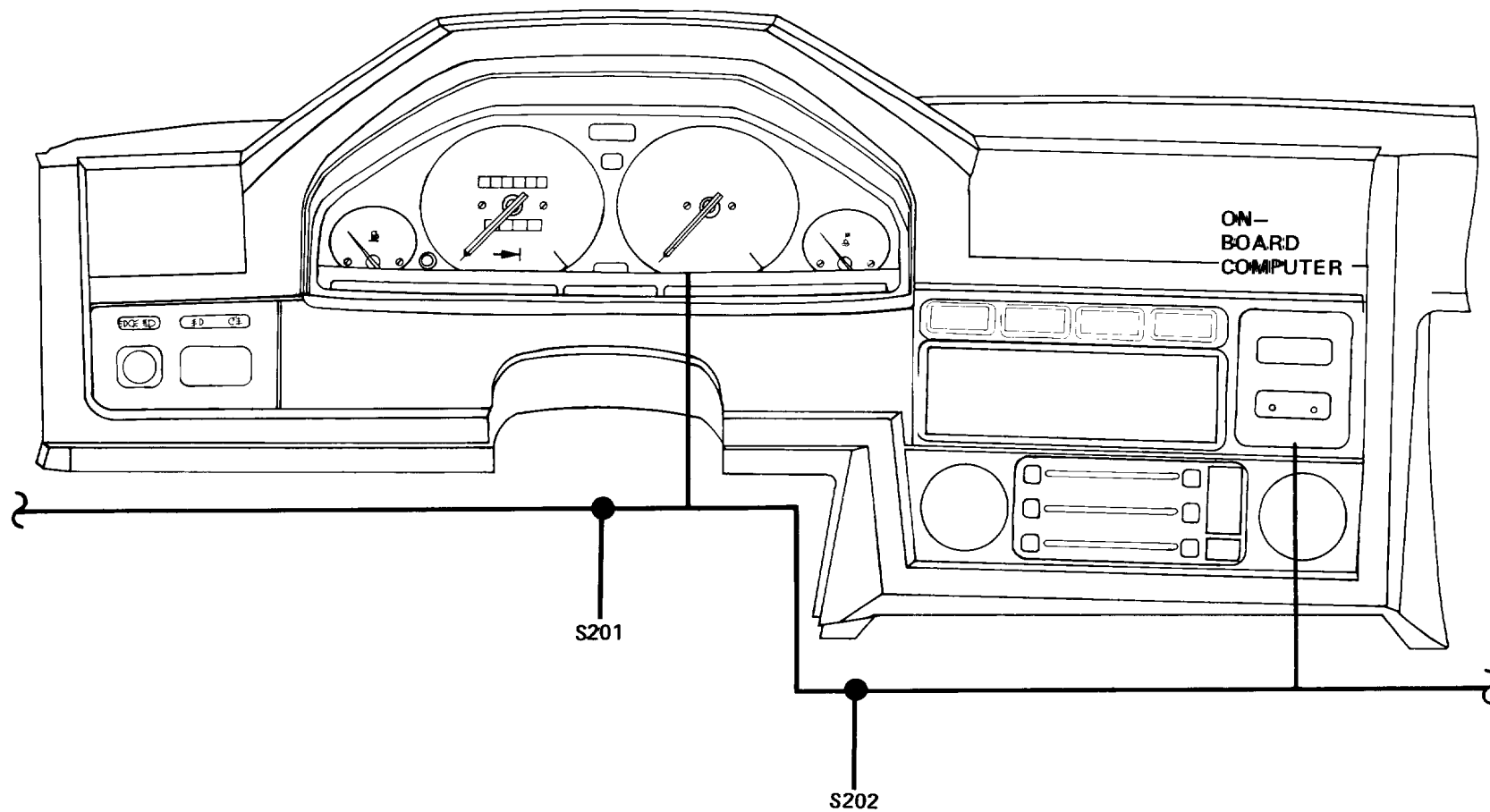

8500-0 CONNECTOR VIEWS
DIAGNOSTIC CONNECTOR

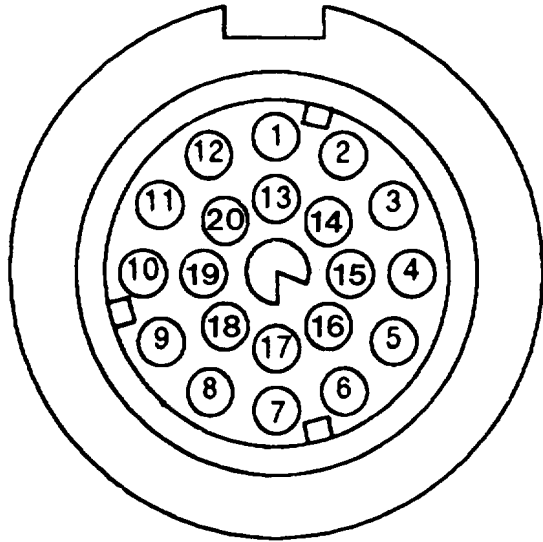

DIAGNOSTIC CONNECTOR FACE

Pin	Wire Size	Wire Color	Circuit and Component Connected
1	1	BK	Ignition Coil, Motronic Control Unit
6	.5	WT/BK	SRS Connector
7	.5	WT/BU	Service Interval Indicator, Service Interval Processor (Reset)
11	2.5	BK/YL	Starter, Start Signal (50)
12	.75	BU	Charge, Alternator (D+)
14	2.5	RD	Battery (+)
15	.5	BK/YL	Motronic Control Unit (RXD)
16	1.5	GN/WT	Oxygen Sensor/Power (318is)
18	.5	GN/BU	Motronic Control Unit (Programming Voltage)
19	1.5	BR	Ground Distribution (G103)
20	.5	WT/VI	Motronic Control Unit (TXD)

ACCESSORY CONNECTOR

CIRCUITS USING C302 (ACCESSORY CONNECTOR)

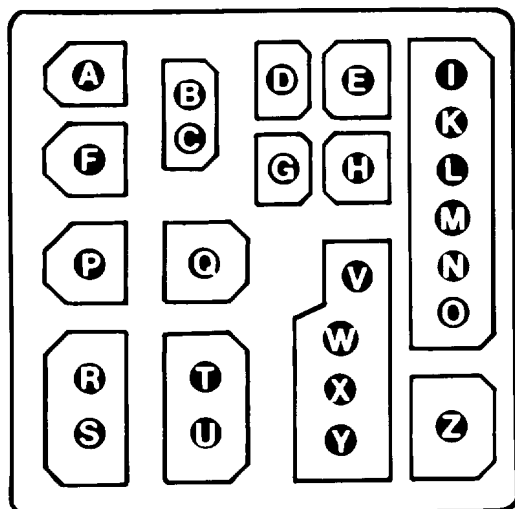
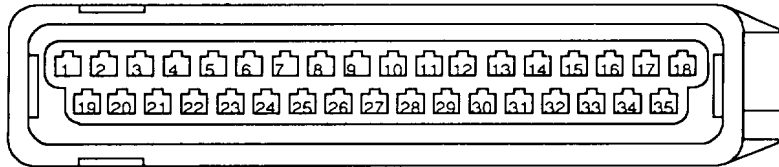

Figure 1-C302 (Accessory Connector)
Front View—Under LH Side
of Dash Ahead of Pedal Assembly

TERMINAL	CIRCUIT	TERMINAL	CIRCUIT
A	Not Used	N	Not Used
B	Not Used	O	Not Used
C	Anti-Lock Braking	P	Not Used
D	Not Used	Q	Power Windows
E	Not Used	R	Anti-Lock Braking
F	Not Used	S	Cruise Control
G	Anti-Lock Braking	T	Not Used
H	Multifunction Clock	U	Not Used
I	Not Used	V	Radio
J	Not Used	W	Radio
K	Not Used	X	Radio
L	Not Used	Y	Radio
M	Not Used	Z	Power Antenna

8500-2 CONNECTOR VIEWS

B350002.04



Mating Face
ABS CONTROL UNIT

B070008.00

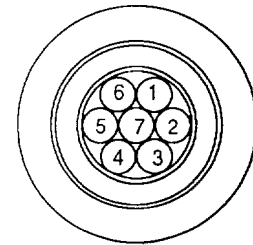

Mating Face
AIR FLOW METER
318is

B120014

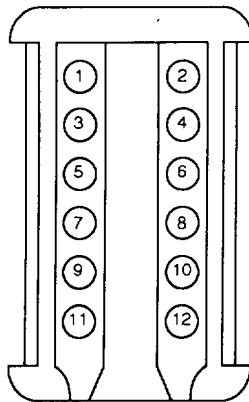

Wiring Face
ABS HYDRAULIC UNIT

B090001.14

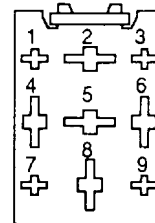

Mating Face
ABS NEUTRAL
INPUT RELAY

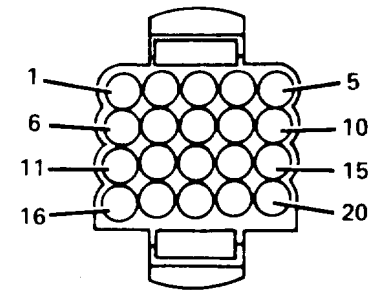

Wiring Face
AMPLIFIER
(SOUND SYSTEM)

B050010.00

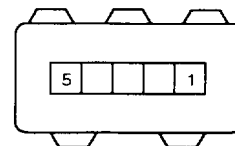

Mating Face
AIR FLOW METER
325i/is, M3, 325ix, 325ic

B080012

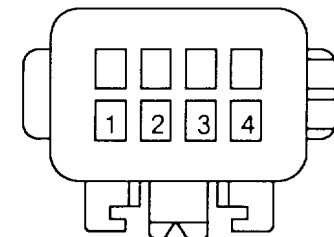

Wiring Face
AUXILIARY FUSE

B260002.01

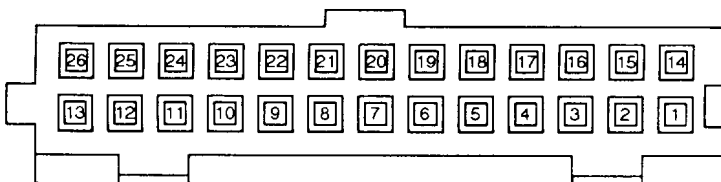

Mating Face
ACTIVE CHECK CONTROL

B090005

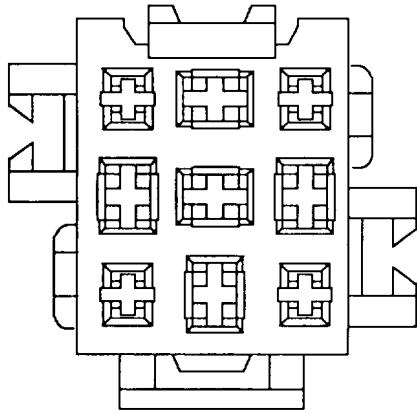

Mating Face
A/C COMPRESSOR CONTROL UNIT
318is

B260002.03

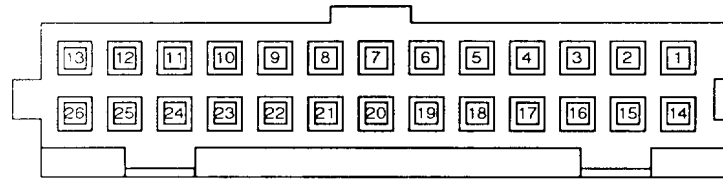

Wiring Face
CRUISE CONTROL
UNIT

B080014.00

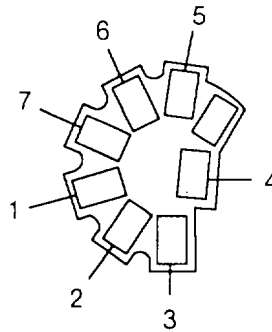

Wiring Face
BLOWER SPEED CONTROL

B030015.03

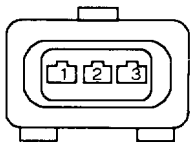

Wiring Face
BAROMETRIC PRESSURE
SENSOR

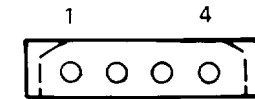

Wiring Face
CHIME MODULE (C1)

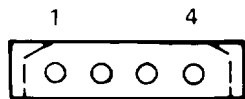

Wiring Face
BLOWER RESISTORS

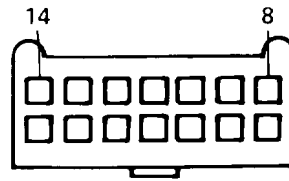

Wiring Face
CENTRAL LOCKING CONTROL UNIT

B040013

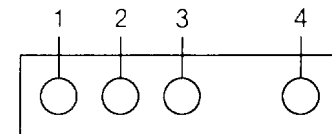

Wiring Face
CHIME MODULE (C2)

8500-4 CONNECTOR VIEWS

B080013.00

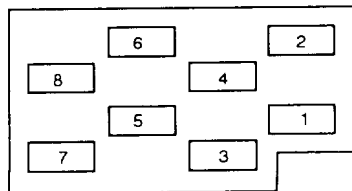

Wiring Face

CONTROL SWITCHES

B030019.00

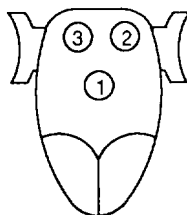

Wiring Face

DUAL TEMPERATURE SWITCH

B060024

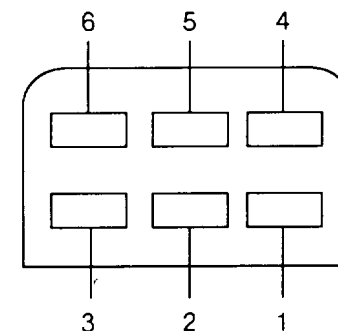

Wiring Face

EVAPORATOR TEMPERATURE
REGULATOR

B030015.05

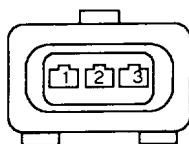

Mating Face

CYLINDER IDENTIFICATION
SENSOR

B030015.04

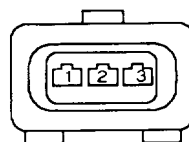

Wiring Face

ENGINE SPEED SENSOR

49A

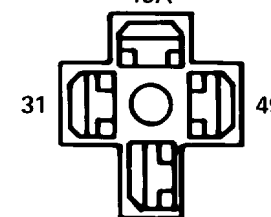

Wiring Face
FLASHER

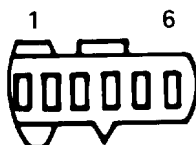

Wiring Face

DOOR LOCK MOTOR

B090001.04

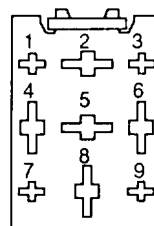

Mating Face

EVAPORATIVE
PURGE VALVE RELAY

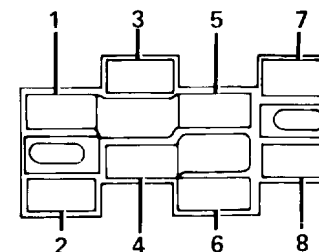

Wiring Face

FOG LIGHT SWITCH

B090001.17

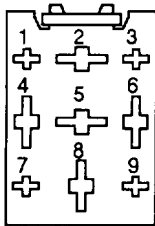

Mating Face

FRESH/RECIRCULATING AIR RELAY

B030017.00

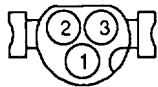

Wiring Face

FRONT TURN/PARK LIGHT

325i/325is, 325ix

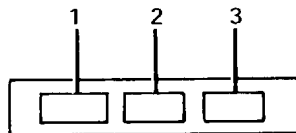

Wiring Face

FRONT TURN/PARK LIGHT

325ic, M3

B030025.00

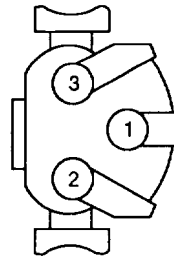

Mating Face

FRONT TURN/PARK LIGHT

318is

B030015.09

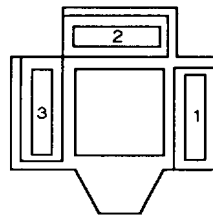

Mating Face

HEADLIGHTS

Low and High Beams

B030015.08

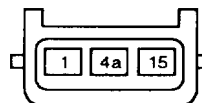

Mating Face

IGNITION COILS

318is

B030020.00

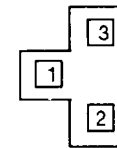

Wiring Face

INSTRUMENT CLUSTER (C6)

B090001.16

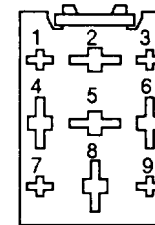

Mating Face

INTERIOR LIGHT TIMER CONTROL

B120006.00

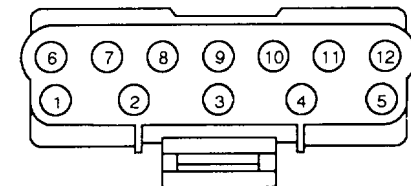

Wiring face

LIGHT SWITCH

8500-6 CONNECTOR VIEWS

B090001.06

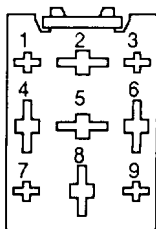

Mating Face
MAIN RELAY

2 6

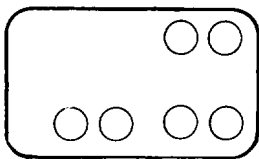

Mating Face
MIRROR CONTROL SWITCH

B030015.06

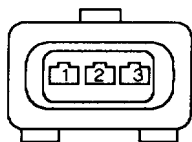

Wiring Face
OIL LEVEL SENSOR

B550001.02

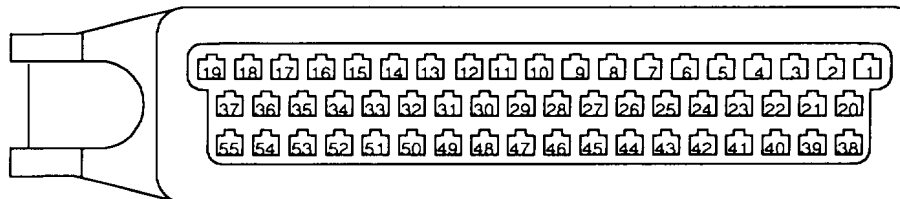

Mating Face
MOTRONIC CONTROL UNIT
All except M3 and 318is

B350002

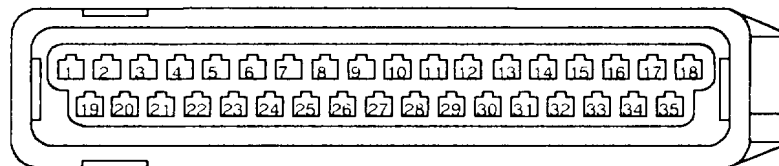

Mating Face
MOTRONIC CONTROL UNIT

B880002.00

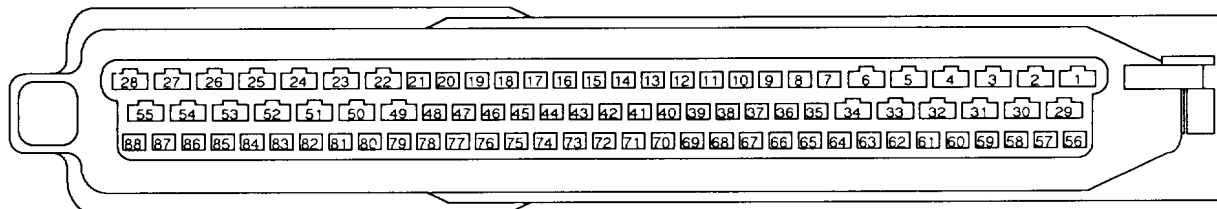

Mating Face
MOTRONIC CONTROL UNIT
318is

B260002.00

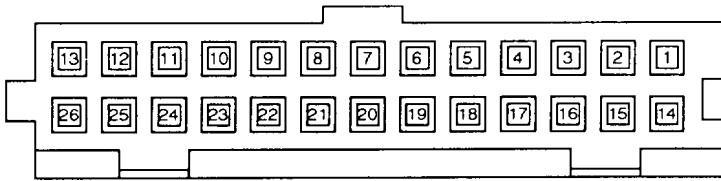

Wiring Face

ON - BOARD COMPUTER MODULE

B090001.05

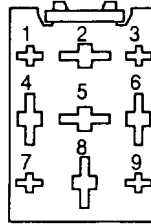

Mating Face

OXYGEN SENSOR HEATER RELAY

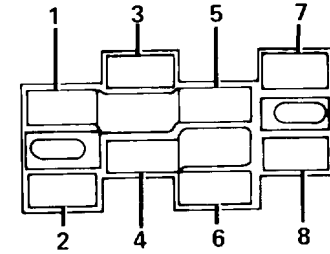

Wiring Face

REAR DEFOGGER SWITCH

B040012.02

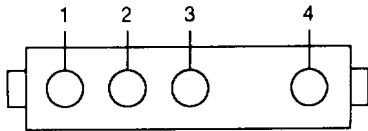

Wiring Face

ON - BOARD COMPUTER
RELAY BOX (C2)

B040012.01

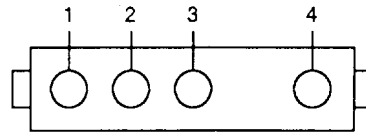

Wiring Face

POWER MIRRORS

B060027.00

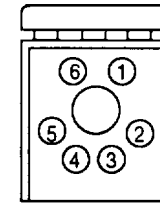

Wiring Face

REAR LIGHT ASSEMBLY

B040018

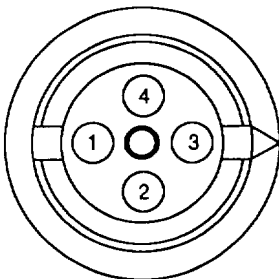

Mating Face

OXYGEN SENSOR HEATER

318is

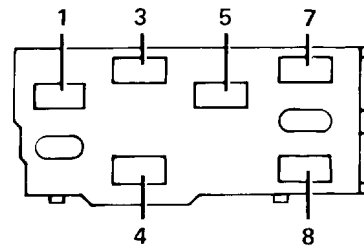

Wiring Face

POWER WINDOW SWITCHES

B060033.00

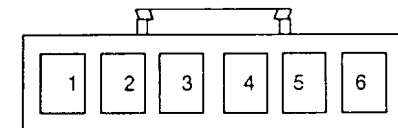

Wiring Face

REAR LIGHT ASSEMBLY

8500-8 CONNECTOR VIEWS

B080015.01

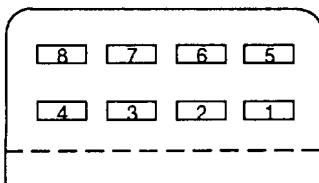

Wiring Face

REAR LIGHTS CHECK RELAY (C1)

B060028 .01

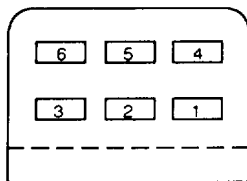

Wiring Face

REAR LIGHTS CHECK RELAY (C2)

B0400002.03

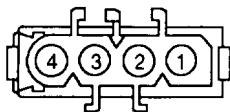

Mating Face

REAR WINDOW BLOWER

B090001.14

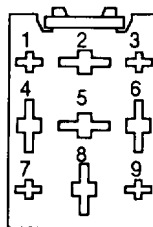

Mating Face

REAR WINDOW BLOWER RELAY

B090001.05

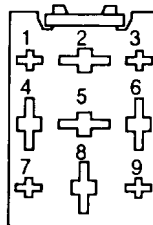

Mating Face

SEATBELT WARNING TIMER

B070009.00

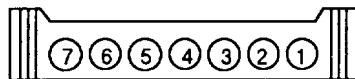

Mating Face

SEATBELT AND SRS WARNING MODULE

318is

B090001.00

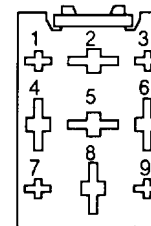

Wiring Face

START RELAY

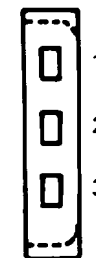

Wiring Face

SUNROOF MOTOR (C1)

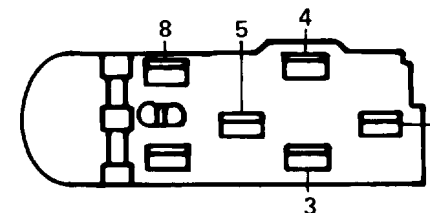

Wiring Face

SUNROOF SWITCH

B030015.07

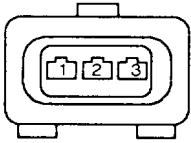

Wiring Face

THROTTLE SWITCH, POTENTIOMETER

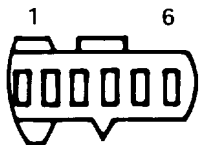

Wiring Face

TRUNK LID LOCK MOTOR

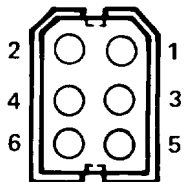

Wiring Face

WIPER MOTOR

B200002.00

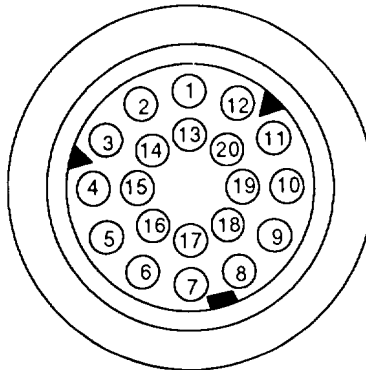

Wiring Face

C101

B300001.00

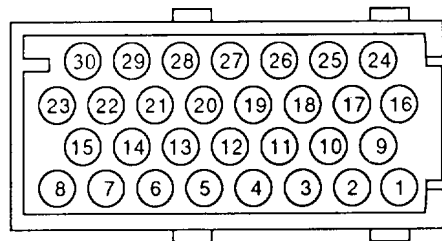

Wiring Face

C103

B030004.02

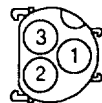

Mating Face

C110

C113



Wiring Face

C114

B040002.00

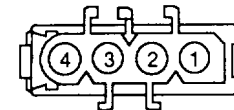

Wiring Face

C107

C131

C136

C270

B040006.01

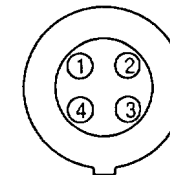

Wiring Face

C140

8500-10 CONNECTOR VIEWS

B030015.06

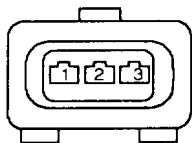

Wiring Face
C152, C153, C154

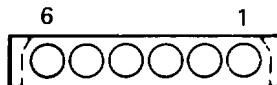

Wiring Face
C201

B120004.00

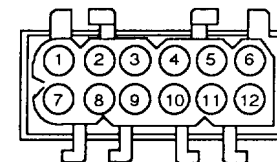

Wiring Face
C204

B070002.00

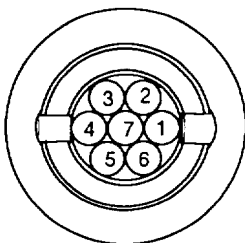

Wiring Face
C191

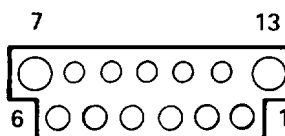

Wiring Face
C202

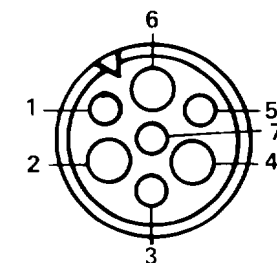

Wiring Face
C209

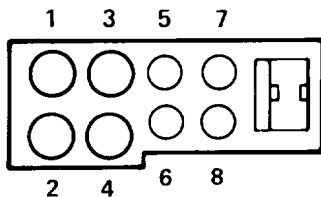

Wiring Face
C200

B060032.00

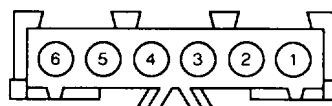

Wiring Face
C203

B070004.00

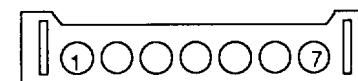

Wiring Face
C210

B060025



Wiring Face

C240

B060003 03

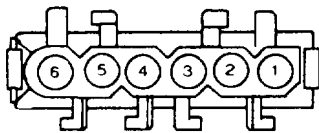

Mating Face

C242

B080002.00

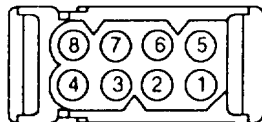

Mating Face

C243

B030001.01

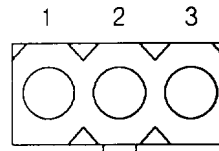

Wiring Face

C303

C304

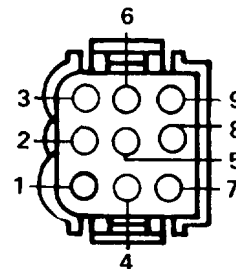

Wiring Face

C306

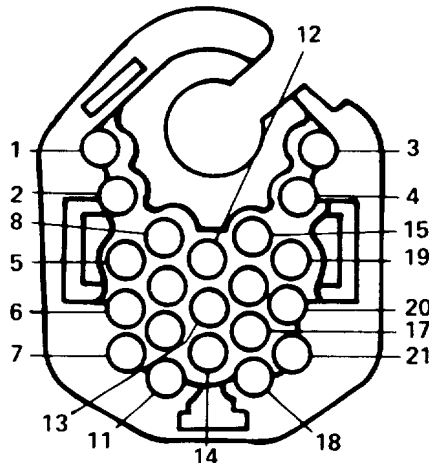

Wiring Face

C404

C405

B050011.00

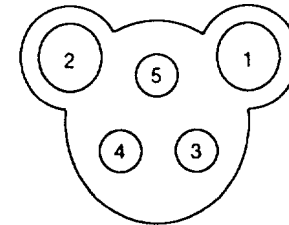

Wiring Face

C413

B040004.00

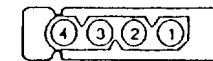

C421

C422

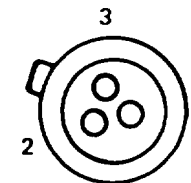

Wiring Face

C503

9000-0 COMPONENT LOCATION CHART

COMPONENTS		Page-Figure
150° Compressor Oil Temperature Switch	Lower RH side of engine compartment, on A/C compressor	7000- 4-1
A/C In-Line Fuse	LH side of evaporator housing	7000- 8-1
ABS Electronic Control Unit	Below LH side of dash, above hood release	7000- 6-3
ABS Hydraulic Unit	LH front corner of engine compartment	7000- 1-2
Active Check Control Unit	Above rear view mirror	7000- 8-6
Air Bag Gas Generator	Center of steering wheel	7000- 7-5
Air Flow Meter	LH front of engine compartment, behind air cleaner	7000- 0-6
Alternator	Top LH front of engine	7000- 2-3
Amplifier	LH side of trunk, above LH wheel well	7000-12-1
Auto-Charging Flashlight	Inside LH side of glove box	7000- 9-6
Auxiliary Fan	In front of radiator	7000- 2-4
Auxiliary Fan Normal Speed Blower Resistor	In front of radiator, LH side of auxiliary fan	7000- 2-4
Auxiliary Fuel Pump	Below RH side of rear seat, in fuel tank, below access panel	7000-11-3
Auxiliary Fuse	LH rear corner of engine compartment, RH side of power distribution box.	7000- 0-1
B/C Horn Diode	Behind LH corner of front bumper, on board computer horn	7000- 1-5
Backup Light Switch	Top RH side of transmission.	7000- 5-1
Barometric Pressure Sensor	LH side of engine compartment, on wheel well brace	7000- 0-6
Battery	In RH rear corner of trunk	7000-12-3
Battery Junction Block	RH rear corner of engine compartment, on bulkhead	7000- 4-5
Blower Motor	Inside fresh air intake cowl.	7000- 0-4
Blower Resistors	Inside cowl, blower housing	
Board Computer Horn	Behind LH corner of front bumper	7000- 1-5
Brake Fluid Level Switch.	LH rear corner of engine compartment, on brake fluid reservoir.	7000- 0-1
Brake Switch	Below LH side of dash, on brake pedal support	7000- 6-5
Brake Wear Sensors.	On LH front and RH rear brake calipers	7000- 5-4
Central Locking Control Unit	Inside LH kick panel, below LH speaker	7000- 6-1
Chime Module.	Mounted on LH dash hush panel	7000- 6-3
Clutch Switch.	Below LH side of dash, on clutch pedal support.	7000- 6-5
Combination Switch	Upper LH side of steering column	7000- 7-4
Compressor Clutch	Lower RH front of engine.	7000- 3-4
Compressor Clutch Diode	Lower RH front of engine, on A/C compressor	7000- 3-4
Coolant Level Switch	Rear of RH front wheel well, in coolant reservoir	7000- 4-3
Coolant Temperature Sender	Lower RH front side of engine, on coolant manifold	7000- 3-6

COMPONENTS	Page-Figure
Coolant Temperature Sensor . . .	Lower RH front side of engine, on coolant manifold . . . 7000- 3-6
Coolant Temperature Switch . . .	Lower RH front corner of engine compartment 7000- 3-5
Cruise Control Actuator	LH front of engine compartment 7000- 1-4
Cruise Control Unit	Behind RH side of dash, above glove box 7000- 9-5
Cylinder Identification Sensor . .	Lower LH rear of engine, on transmission bell housing 7000- 5-2
Diagnostic Connector	LH side of bulkhead, by power distribution box 7000- 0-3
Door Lock Motors	Rear part of respective doors 7000-10-4
Dual Temperature Switch	Lower RH front corner of engine compartment 7000- 3-5
Engine Speed Sensor	Lower LH rear of engine, on transmission bell housing 7000- 5-2
Evaporative Purge Valve	Lower LH side of engine compartment, forward of shock tower 7000- 0-6
Evaporative Purge Valve Relay . .	RH rear corner of engine compartment, on bulkhead 7000- 4-5
Evaporator Temperature Regulator	On LH side of evaporator housing 7000- 7-6
Evaporator Temperature Sensor .	On LH side of evaporator housing 7000- 7-6
Flasher	Upper part of steering column 7000- 7-4
Fresh/Recirculating Air Flap Door Motors	Behind A/C face plate, on either side of evaporator housing 7000- 8-2
Fresh/Recirculating Air Relays . .	Behind A/C face plate 7000- 8-3
Fuel Injectors	Top of engine, at each intake port 7000- 2-2
Fuel Tank Sender	Below RH side of rear seat, in fuel tank, below access panel 7000-11-3
Gas Filler Lock Motor	RH side of trunk, behind RH wheel well 7000-12-3
Glove Box Light Switch	Behind RH side of dash, above glove box 7000- 9-5
Hazard Switch	Center of dash, above digital radio 7000- 8-4
Horn Brush/Slip Ring	In upper part of steering column 7000- 7-4
Hot Water Cut-Off Switch	Behind center of dash, near rotary temperature control 7000- 8-3
Idle Speed Actuator	Top center front of engine 7000- 2-1
Ignition Coil	On RH front wheel well, forward of shock tower . . . 7000- 4-3
Ignition Key Switch	Top of steering column, part of ignition switch
Ignition Switch	Top RH side of steering column 7000- 7-4
Interior Light Timer Control	Inside LH kick panel, below speaker 7000- 6-1
Left Front Crash Sensor	LH side of engine compartment, front of shock tower 7000- 1-1
LH Horn	Behind LH corner of front bumper 7000- 1-5
LH Jet Heater	Center of engine compartment hood, on washer jet . 7000- 2-5
Lock Heater	In top rear of LH door 7000-10-5

9000-2 COMPONENT LOCATION CHART

COMPONENTS		Page-Figure
Lock Heater Control Unit	In top rear of LH door	7000-10-6
Loop Contact Rings	Inside steering wheel, below air bag gas generator	7000- 7-3
Main Fuel Pump	Below LH rear of car, in front of rear wheel.	7000-11-5
Main Relay	RH rear corner of engine compartment, on bulkhead	7000- 4-5
Motor Relay	Center of windshield header, above rear view mirror	7000- 9-1
Motronic Control Unit	Behind RH side of dash, above glove box	7000- 9-5
Oil Pressure Switch	Lower LH front of engine	7000- 1-3
Oil Temperature Sensor	Lower LH front of engine	7000- 1-3
On-Board Computer Module	Center of dash, on RH side of digital radio	7000- 8-5
On-Board Computer Relay Box.	Below LH side of dash, behind ABS electronic control unit	7000- 6-4
Outside Temperature Sensor	Behind splash guard, near LH fog light	7000- 1-6
Oxygen Sensor	Lower RH rear of engine compartment, on exhaust manifold	7000- 4-6
Oxygen Sensor/Fuel Pump Relay	RH rear corner of engine compartment, on bulkhead	7000- 4-5
Park Brake Switch	At base of parking brake	7000- 9-3
Power Distribution Box.	LH rear corner of engine compartment.	7000- 0-1
Power Window Circuit Breaker	On center console, near gear shift lever	7000- 9-2
Pulse Wheels	On respective wheel assemblies, in brake housing	7000- 5-3
Rear Lights Check Relay	LH side of trunk, above LH wheel well	7000-12-1
Refrigerant Pressure Switch	RH front corner of engine compartment	7000- 3-2
RH Front Door Micro Switch	In top rear of RH door	7000-10-5
RH Horn.	Behind RH corner of front bumper	7000- 3-3
RH Jet Heater.	Center of engine compartment hood, on washer jet	7000- 2-5
Right Front Crash Sensor	RH side of engine compartment, forward of shock tower	7000- 4-4
Seatbelt Switch	In driver's seatbelt buckle assembly	
Seatbelt Warning Timer	Behind LH side of dash, on electrical bracket	7000- 7-1
Speed Detectors	On respective wheel assemblies, in brake housing	7000- 5-3
Speedometer Sender	RH rear of rear differential	7000-11-6
SRS Diagnostic Module	Behind LH side of dash, above ABS electronic control unit	7000- 6-2
Starter.	Lower LH rear of engine	
Sunroof Motor	Center of windshield header, above rear view mirror	7000- 9-1
TDC Sensor	Lower LH rear of engine	7000- 0-5
Throttle Switch.	Top center front of engine	7000- 2-1
Trunk Lid Lock Motor.	On trunk lock center support	7000-12-2
Trunk Light Switch	Top center of trunk lid.	7000-12-4
Unlock Inhibit Switch.	Top rear of LH door.	7000-10-5

COMPONENTS

		Page-Figure
Washer Fluid Level Switch	Behind RH headlight, on windshield washer fluid reservoir	7000- 3-1
Washer Pump	Ahead of RH front wheel well, on windshield washer fluid reservoir	7000- 4-2
Water Shut-Off Solenoid.	LH side of evaporator housing	7000- 8-1
Window Motors	Forward part of respective doors.	7000-10-3
Wiper Motor	Inside LH side of fresh air intake cowl	7000- 0-4

CONNECTORS

C101 (20 pins)	Next to power distribution box, mounted on engine dash	7000- 0-3
C103 (30 pins)	Below LH side of dash, on body electrical bracket	7000- 6-4
C104 (2 pins)	Below LH side of dash, near C302 accessory connector	7000- 6-4
C106 (2 pins)	RH side of engine compartment, behind windshield washer fluid reservoir	7000- 4-2
C107 (4 pins)	Behind RH side of dash, above glove box	7000- 9-4
C110 (2 pins)	RH front of engine compartment.	7000- 3-1
C113 (3 pins)	LH front of engine compartment, behind headlight.	7000- 1-2
C114 (8 pins)	LH rear corner of engine compartment, under power distribution box	7000- 0-2
C115 (2 pins)	LH rear corner of engine compartment, under power distribution box	7000- 0-2
C126 (2 pins)	Behind LH corner of front bumper, above fog light	7000- 1-5
C127 (2 pins)	Behind RH corner of front bumper, above fog light.	7000- 3-3
C130 (1 pin)	Behind RH side of dash, in harness, above glove box	
C140 (3 pins)	RH rear of engine compartment, under tray	7000- 4-3
C142 (1 pin)	Below LH side of dash, near steering column	7000- 6-5
C143 (1 pin)	Below LH side of dash, near C302 accessory connector	7000- 6-6
C150 (2 pins)	Front of LH front wheel well, on bracket	7000- 0-6
C151 (2 pins)	Front of RH front wheel well	7000- 4-1
C152 (3 pins)	Center of bulkhead, above rear of engine	7000- 0-3
C153 (3 pins)	Center of bulkhead, above rear of engine	7000- 0-3
C154 (3 pins)	Center of bulkhead, above rear of engine	7000- 0-3
C156 (2 pins)	RH front corner of engine compartment	7000- 3-2
C157 (2 pins)	LH front corner of engine compartment	7000- 1-2
C157 (2 pins)	LH front of engine compartment	7000- 1-2
C200 (10 pins)	Below LH side of dash, on steering column.	7000- 6-5
C201 (6 pins)	Below LH side of dash, on steering column.	7000- 6-5
C202 (13 pins)	Below LH side of dash, on steering column.	7000- 6-5
C203 (8 pins)	Below LH side of dash, below C302 accessory connector	7000- 6-6
C204 (12 pins)	Below LH side of dash, RH side of steering column	7000- 8-2

CONNECTORS

Page-Figure

C205 (2 pins)	Inside LH kick panel, behind speaker	7000- 6-1
C209 (7 pins)	Below LH side of dash, near brake pedal support	7000- 6-6
C210 (7 pins)	Below LH side of dash, on steering column	7000- 6-5
C213 (1 pin)	Behind center of dash, on digital radio	7000- 8-4
C214 (1 pin)	Behind center of dash, on digital radio	7000- 8-4
C215 (2 pins)	Behind center of dash, behind digital radio	7000- 8-5
C216 (2 pins)	Behind center of dash, on digital radio	7000- 8-4
C217 (1 pin)	Below LH side of dash, near brake pedal support	7000- 6-6
C233 (1 pin)	Behind center of dash, near digital radio	7000- 8-5
C240 (6 Pins)	Below LH side of dash, on SRS diagnostic module bracket	7000- 6-2
C242 (2 pins)	Behind center of dash, on digital radio	7000- 8-4
C243 (8 pins)	Behind center of dash, near digital radio	7000- 8-5
C260 (2 pins)	Underside of steering column, above access panel	7000- 7-2
C261 (2 pins)	Below LH side of dash, near C302 accessory connector	7000- 6-6
C270 (4 pins)	Below LH side of dash, on SRS diagnostic module bracket	7000- 6-2
C290 (2 pins)	Below LH side of dash, on SRS diagnostic module bracket	7000- 6-2
C301 (2 pins)	Below center console, near gear shift lever	7000- 9-2
C302 (25 pins) Accessory Connector	Below LH side of dash, on body electrical bracket	7000- 6-4
C303 (3 pins)	At base of RH "B" pillar	7000-11-4
C304 (3 pins)	At base of LH "B" pillar	7000-11-1
C305 (1 pin)	Behind LH side of dash, near C302 accessory connector	7000- 6-4
C352 (2 pins)	Below LH side of rear seat	7000-11-2
C360 (2 pins)	Behind RH side of rear seat	7000-11-3
C404 (21 pins)	Above RH front door jamb switch	7000-10-2
C405 (21 pins)	Above LH front door jamb switch	7000- 5-5
C406 (1 pin)	Below RH front speaker	7000-10-1
C407 (1 pin)	Below LH front speaker	7000- 5-6
C421 (4 pins)	Below driver's seat	
C422 (4 pins)	Below passenger's seat	
C500 (1 pin)	Below LH side of dash, near steering column	7000- 6-5
C503 (3 pins)	In lower rear of LH door	7000-10-4

CONNECTORS

Page-Figure

C510 (1 pin)	Inside LH kick panel, above speaker	7000- 6-1
C560 (1 pin)	In top rear of LH door	7000-10-5

GROUNDS

G100.	RH rear corner of trunk, behind battery	7000-12-3
G103.	Behind RH side of dash, above glove box	7000- 9-4
G104.	On inner fender, behind LH headlight.	7000- 1-4
G106.	RH front corner of engine compartment	7000- 2-6
G200.	Below LH side of dash, above clutch pedal	7000- 6-5
G201 (Steering Column Ground)	Top LH side of steering column.	7000- 7-4
G202.	Below LH side of dash, above clutch pedal	7000- 6-5
G300.	Behind LH side of rear seat.	7000-11-2
G600.	Center of windshield header, right of sunroof motor.	7000- 9-1